

Series TC15

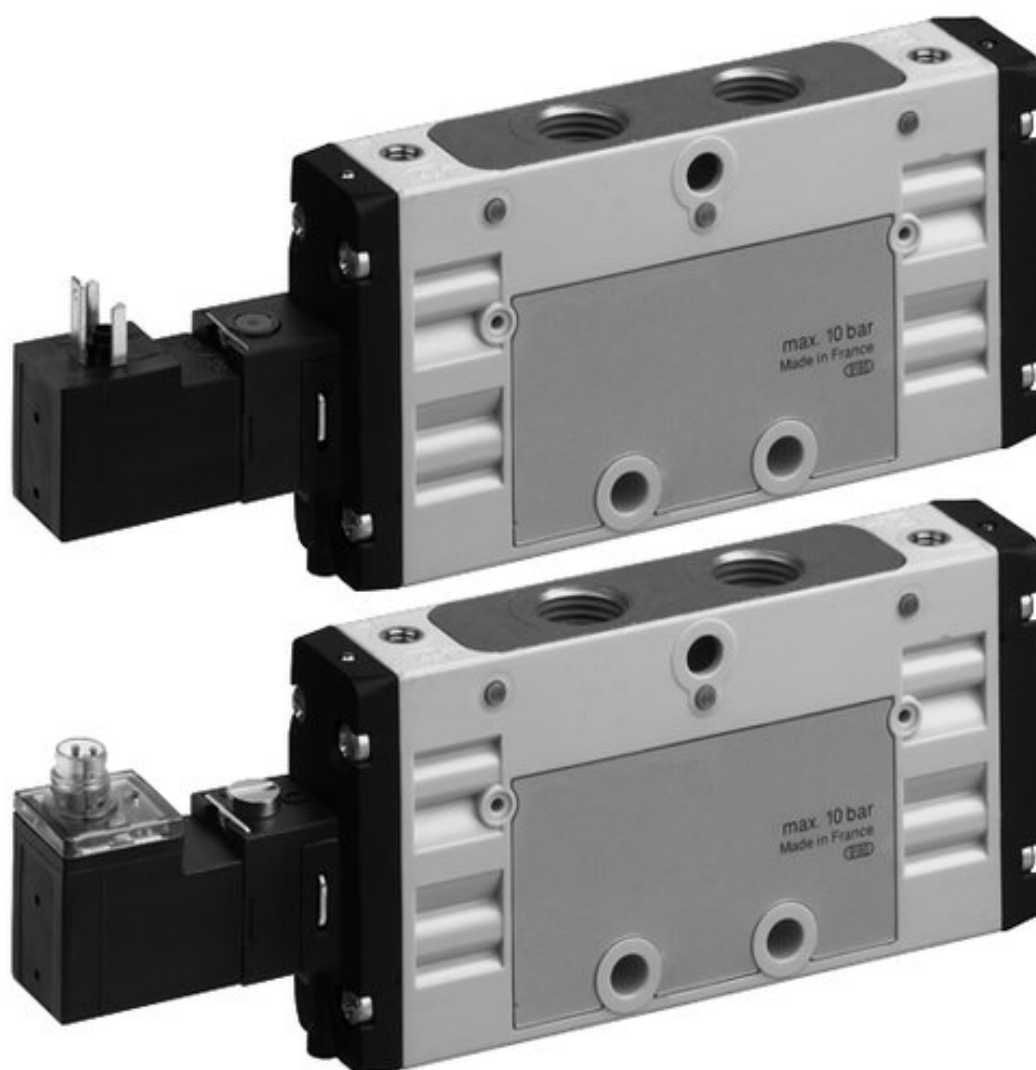

AVENTICS™ Series TC15















2x3/2-directional valve, Series TC15

- Operating voltage 24 V DC
- 2x3/2
- Qn = 1100 l/min
- Pilot valve width : 15 mm
- NC/NC NO/NO NC/NO
- Pipe connection
- Compressed air connection output : G 1/4
- Electrical connection : Plug, M8, 3-pin
- Manual override : with detent
- double solenoid
- With spring return
- Pilot : External, Internal



Version	Spool valve, positive overlapping
Activation	Electrically
Pilot	External, Internal
Sealing principle	Soft sealing
Working pressure min./max.	See table below
Control pressure min./max.	3 ... 10 bar
Ambient temperature min./max.	-10 ... 50 °C
Medium temperature min./max.	-10 ... 50 °C
Medium	Compressed air
Max. particle size	5 µm
Oil content of compressed air	0 ... 5 mg/m ³
Nominal flow Qn	1100 l/min
Compressed air connection	according to ISO 228-1
Connector standard	DIN EN 60947-5-2
Protection class acc. to DIN EN 61140	Class III
Electrically	
Protection class with connection	IP65
LED status display	Yellow
Duty cycle	100 %
Typ. switch-on time	12 ms
Typ. switch-off time	16 ms
Mounting on manifold strip	P-strip
Mounting screw tightening torque	2.5 Nm
Tightening torque tolerance	±0,2 mT
Weight	0.279 kg

Technical data

Part No.		MO		Compressed air connection	
				Input	
R422102190			NC/NC		G 1/4
R422102191			NO/NO		G 1/4
R422102192			NC/NO		G 1/4
R422102193			NC/NC		G 1/4
R422102194			NO/NO		G 1/4
R422102195			NC/NO		G 1/4

Part No.	Compressed air connection	
	Output	Exhaust
R422102190	G 1/4	G 1/4
R422102191	G 1/4	G 1/4
R422102192	G 1/4	G 1/4
R422102193	G 1/4	G 1/4
R422102194	G 1/4	G 1/4
R422102195	G 1/4	G 1/4

Part No.	Compressed air connection		Operational voltage	Voltage tolerance
	Pilot Input			
R422102190	-		24 V	-10% / +10%
R422102191	-		24 V	-10% / +10%
R422102192	-		24 V	-10% / +10%
R422102193	M5		24 V	-10% / +10%
R422102194	M5		24 V	-10% / +10%
R422102195	M5		24 V	-10% / +10%

Part No.	Power consumption	Flow conductance	Flow conductance	Nominal resistance
	DC	b	C-value	
R422102190	2.2 W	0.25	5.9 l/(s*bar)	280 Ω
R422102191	2.2 W	0.25	5.9 l/(s*bar)	280 Ω
R422102192	2.2 W	0.25	5.9 l/(s*bar)	280 Ω
R422102193	2.2 W	0.25	5.9 l/(s*bar)	280 Ω
R422102194	2.2 W	0.25	5.9 l/(s*bar)	280 Ω
R422102195	2.2 W	0.25	5.9 l/(s*bar)	280 Ω

Part No.	Working pressure min./max.
R422102190	3 ... 10 bar
R422102191	3 ... 10 bar
R422102192	3 ... 10 bar
R422102193	-0.9 ... 10 bar
R422102194	-0.9 ... 10 bar
R422102195	-0.9 ... 10 bar

Nominal flow Q_n at 6 bar and Δp = 1 bar, MO = Manual override

Technical information

The min. control pressure must be adhered to, since otherwise faulty switching and valve failure may result!

The pressure dew point must be at least 15 °C under ambient and medium temperature and may not exceed 3 °C .

The oil content of compressed air must remain constant during the life cycle.

Use only the approved oils from AVENTICS. Further information can be found in the "Technical information" document (available in the MediaCentre).

Technical information

Material	
Housing	Polyamide fiber-glass reinforced
Seals	Acrylonitrile butadiene rubber Hydrogenated nitrile butadiene rubber
Front plate	Polyamide fiber-glass reinforced
Threaded bushing	Brass Die cast zinc, nickel-plated chrome-plated

Dimensions

Dimensions

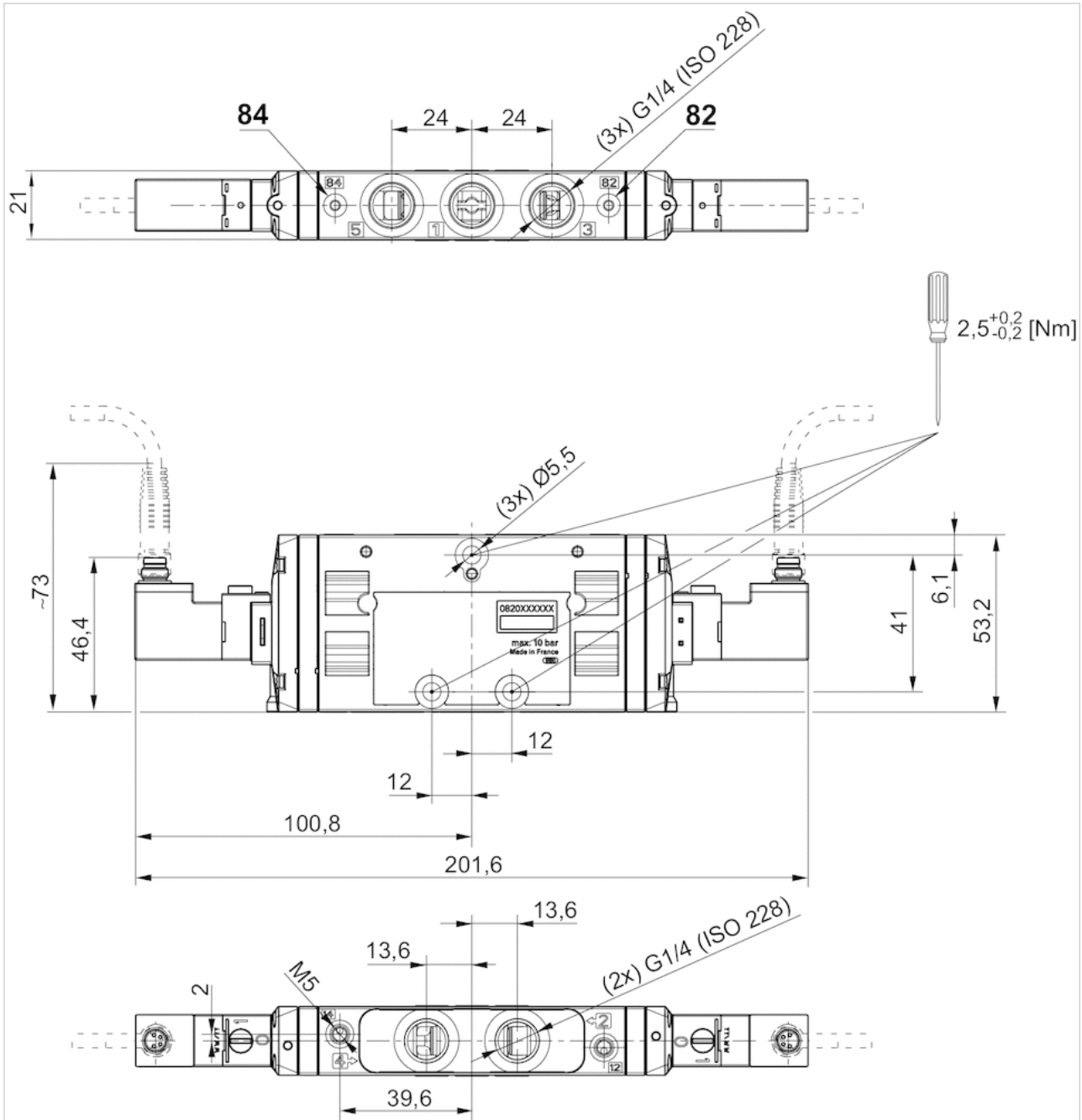

Pin assignments

PIN assignment and cable colors for valve plug connectors

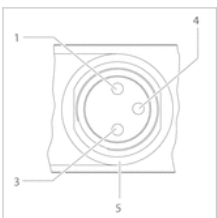

PIN assignment:
1) PIN not assigned

- 3) 0 V
- 4) 24 V
- 5) LED

Cable color

- 1) Brown
- 3) Blue
- 4) Black

Note: Bi-polar protective circuit to prevent overvoltage













2x3/2-directional valve, Series TC15

- Operating voltage 24 V DC
- 2x3/2
- Qn = 1100 l/min
- Pilot valve width : 15 mm
- NC/NC NO/NO NC/NO
- Pipe connection
- Compressed air connection output : G 1/4
- Electrical connection : Plug, M8, 4-pin
- Manual override : without detent
- double solenoid
- With spring return
- Pilot : External, Internal



Version	Spool valve, positive overlapping
Activation	Electrically
Pilot	External, Internal
Sealing principle	Soft sealing
Working pressure min./max.	See table below
Control pressure min./max.	3 ... 10 bar
Ambient temperature min./max.	-10 ... 50 °C
Medium temperature min./max.	-10 ... 50 °C
Medium	Compressed air
Max. particle size	5 µm
Oil content of compressed air	0 ... 5 mg/m ³
Nominal flow Qn	1100 l/min
Compressed air connection	according to ISO 228-1
Connector standard	DIN EN 60947-5-2
Protection class acc. to DIN EN 61140 Electrically	Class III
Protection class with connection	IP65
LED status display	Yellow
Duty cycle	100 %
Typ. switch-on time	12 ms
Typ. switch-off time	16 ms
Generic immunity standard in accordance with	EN 50082-2
Mounting on manifold strip	P-strip
Mounting screw tightening torque	2.5 Nm
Tightening torque tolerance	±0,2 mT
Weight	0.279 kg

Technical data

Part No.		MO	Compressed air connection		
				Input	
R422102184				NC/NC	G 1/4
R422102185				NO/NO	G 1/4
R422102186				NC/NO	G 1/4
R422102187				NC/NC	G 1/4
R422102188				NO/NO	G 1/4
R422102189				NC/NO	G 1/4

Part No.	Compressed air connection	
	Output	Exhaust
R422102184	G 1/4	G 1/4
R422102185	G 1/4	G 1/4
R422102186	G 1/4	G 1/4
R422102187	G 1/4	G 1/4
R422102188	G 1/4	G 1/4
R422102189	G 1/4	G 1/4

Part No.	Compressed air connection		Operational voltage	Voltage tolerance
		Pilot Input		
R422102184	-	-	24 V	-10% / +10%
R422102185	-	-	24 V	-10% / +10%
R422102186	-	-	24 V	-10% / +10%
R422102187	M5	M5	24 V	-10% / +10%
R422102188	M5	M5	24 V	-10% / +10%
R422102189	M5	M5	24 V	-10% / +10%

Part No.	Power consumption	Flow conductance	Flow conductance	Nominal resistance
	DC	b	C-value	
R422102184	2.2 W	0.25	5.9 l/(s*bar)	280 Ω
R422102185	2.2 W	0.25	5.9 l/(s*bar)	280 Ω
R422102186	2.2 W	0.25	5.9 l/(s*bar)	280 Ω
R422102187	2.2 W	0.25	5.9 l/(s*bar)	280 Ω
R422102188	2.2 W	0.25	5.9 l/(s*bar)	280 Ω
R422102189	2.2 W	0.25	5.9 l/(s*bar)	280 Ω

Part No.	Working pressure min./max.
R422102184	3 ... 10 bar
R422102185	3 ... 10 bar
R422102186	3 ... 10 bar
R422102187	-0.9 ... 10 bar
R422102188	-0.9 ... 10 bar
R422102189	-0.9 ... 10 bar

Nominal flow Q_n at 6 bar and Δp = 1 bar, MO = Manual override

Technical information

The min. control pressure must be adhered to, since otherwise faulty switching and valve failure may result!

The pressure dew point must be at least 15 °C under ambient and medium temperature and may not exceed 3 °C .

The oil content of compressed air must remain constant during the life cycle.

Use only the approved oils from AVENTICS. Further information can be found in the "Technical information" document (available in the MediaCentre).

Technical information

Material	
Housing	Polyamide fiber-glass reinforced
Seals	Acrylonitrile butadiene rubber Hydrogenated nitrile butadiene rubber
Front plate	Polyamide fiber-glass reinforced
Threaded bushing	Brass Die cast zinc, nickel-plated chrome-plated

Dimensions

Dimensions

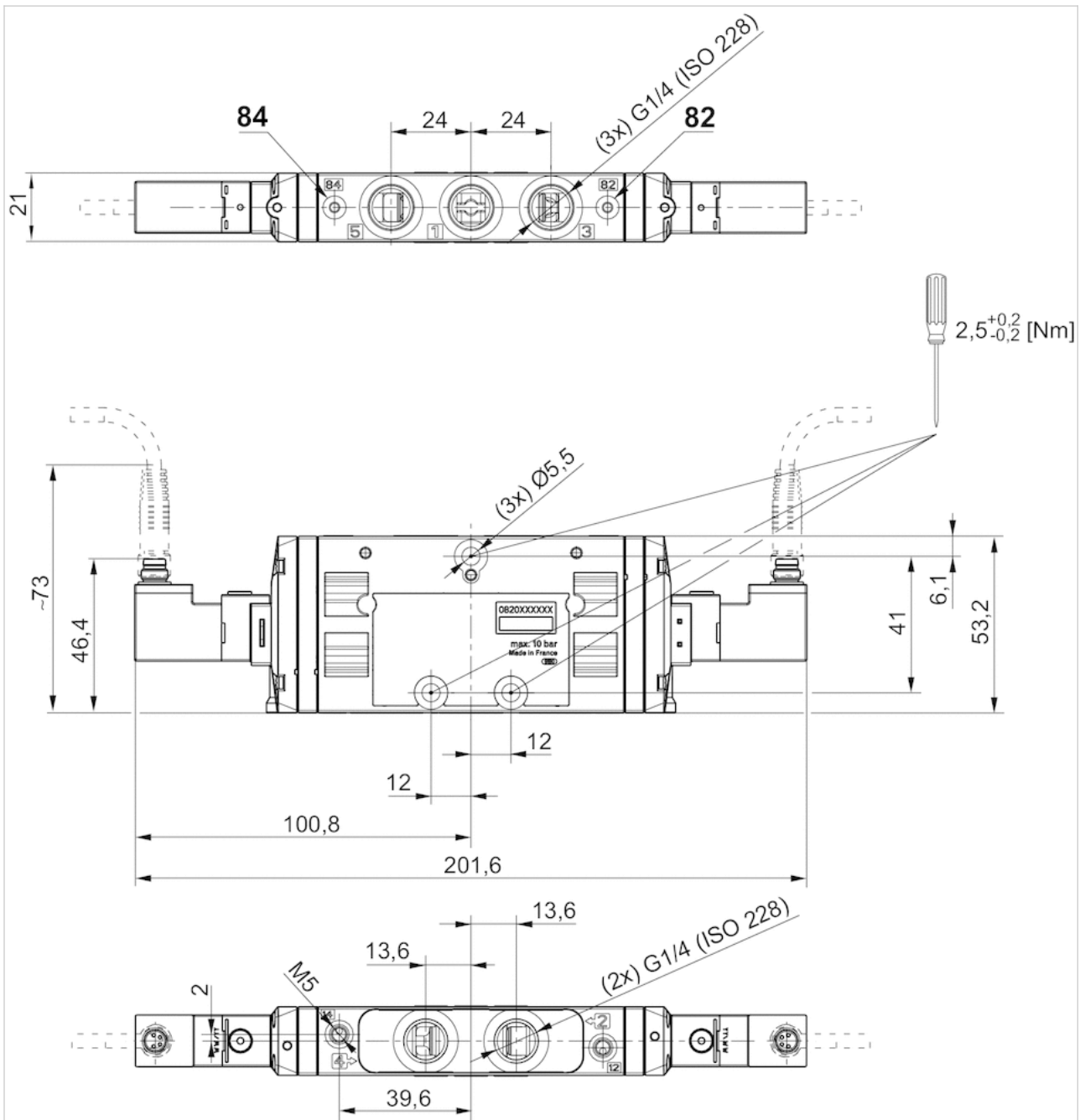

Pin assignments

PIN assignment and cable colors for valve plug connectors

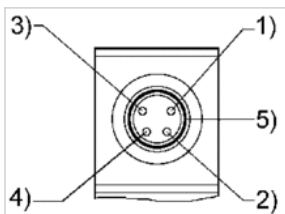

PIN assignment:
1) PIN not assigned

- 2) PIN not assigned
- 3) 0 V
- 4) 24 V
- 5) LED

Cable colors

- 1) Brown
- 2) White
- 3) Blue
- 4) Black













2x3/2-directional valve, Series TC15

- Operating voltage 24 V DC
- 2x3/2
- Qn = 1100 l/min
- Pilot valve width : 15 mm
- NC/NC NO/NO NC/NO
- Pipe connection
- Compressed air connection output : G 1/4
- Electrical connection : Plug, M8, 4-pin
- Manual override : with detent
- double solenoid
- With spring return
- Pilot : External, Internal



Version	Spool valve, positive overlapping
Activation	Electrically
Pilot	External, Internal
Sealing principle	Soft sealing
Working pressure min./max.	See table below
Control pressure min./max.	3 ... 10 bar
Ambient temperature min./max.	-10 ... 50 °C
Medium temperature min./max.	-10 ... 50 °C
Medium	Compressed air
Max. particle size	5 µm
Oil content of compressed air	0 ... 5 mg/m ³
Nominal flow Qn	1100 l/min
Compressed air connection	according to ISO 228-1
Connector standard	DIN EN 60947-5-2
Protection class acc. to DIN EN 61140 Electrically	Class III
Protection class with connection	IP65
LED status display	Yellow
Duty cycle	100 %
Typ. switch-on time	12 ms
Typ. switch-off time	16 ms
Generic immunity standard in accordance with	EN 50082-2
Mounting on manifold strip	P-strip
Mounting screw tightening torque	2.5 Nm
Tightening torque tolerance	±0,2 mT
Weight	0.279 kg

Technical data

Part No.		MO		Compressed air connection	
				Input	
R422102178			NC/NC		G 1/4
R422102179			NO/NO		G 1/4
R422102180			NC/NO		G 1/4
R422102181			NC/NC		G 1/4
R422102182			NO/NO		G 1/4
R422102183			NC/NO		G 1/4

Part No.	Compressed air connection	
	Output	Exhaust
R422102178	G 1/4	G 1/4
R422102179	G 1/4	G 1/4
R422102180	G 1/4	G 1/4
R422102181	G 1/4	G 1/4
R422102182	G 1/4	G 1/4
R422102183	G 1/4	G 1/4

Part No.	Compressed air connection		Operational voltage	Voltage tolerance
	Pilot Input			
R422102178	-		24 V	-10% / +10%
R422102179	-		24 V	-10% / +10%
R422102180	-		24 V	-10% / +10%
R422102181	M5		24 V	-10% / +10%
R422102182	M5		24 V	-10% / +10%
R422102183	M5		24 V	-10% / +10%

Part No.	Power consumption	Flow conductance	Flow conductance	Nominal resistance
	DC	b	C-value	
R422102178	2.2 W	0.25	5.9 l/(s*bar)	280 Ω
R422102179	2.2 W	0.25	5.9 l/(s*bar)	280 Ω
R422102180	2.2 W	0.25	5.9 l/(s*bar)	280 Ω
R422102181	2.2 W	0.25	5.9 l/(s*bar)	280 Ω
R422102182	2.2 W	0.25	5.9 l/(s*bar)	280 Ω
R422102183	2.2 W	0.25	5.9 l/(s*bar)	280 Ω

Part No.	Working pressure min./max.
R422102178	3 ... 10 bar
R422102179	3 ... 10 bar
R422102180	3 ... 10 bar
R422102181	-0.9 ... 10 bar
R422102182	-0.9 ... 10 bar
R422102183	-0.9 ... 10 bar

Nominal flow Q_n at 6 bar and Δp = 1 bar, MO = Manual override

Technical information

The min. control pressure must be adhered to, since otherwise faulty switching and valve failure may result!

The pressure dew point must be at least 15 °C under ambient and medium temperature and may not exceed 3 °C .

The oil content of compressed air must remain constant during the life cycle.

Use only the approved oils from AVENTICS. Further information can be found in the "Technical information" document (available in the MediaCentre).

Technical information

Material	
Housing	Polyamide fiber-glass reinforced
Seals	Acrylonitrile butadiene rubber Hydrogenated nitrile butadiene rubber
Front plate	Polyamide fiber-glass reinforced
Threaded bushing	Brass Die cast zinc, nickel-plated chrome-plated

Dimensions

Dimensions

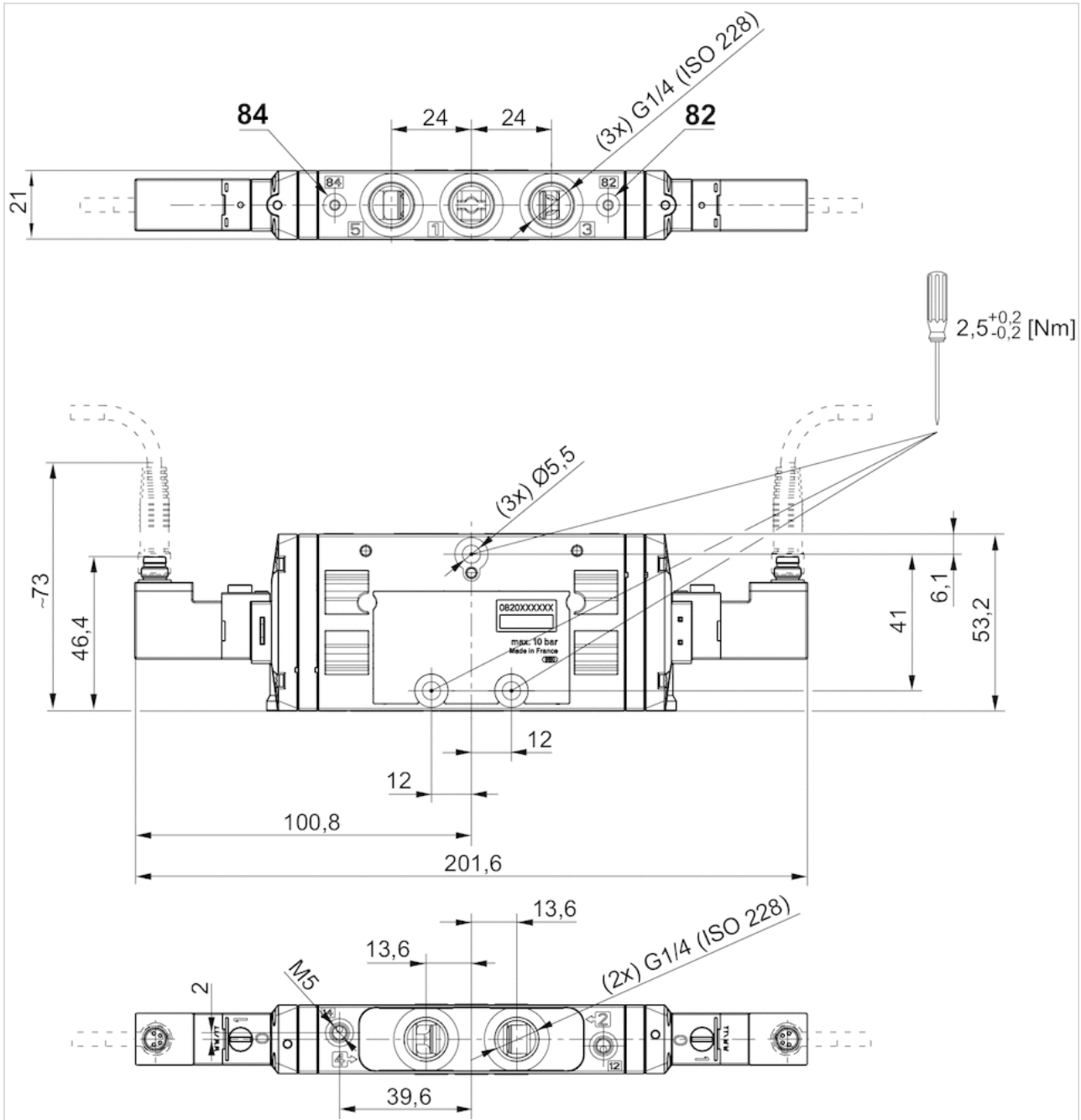

Pin assignments

PIN assignment and cable colors for valve plug connectors

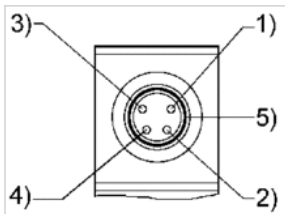

PIN assignment:
1) PIN not assigned

2) PIN not assigned

3) 0 V

4) 24 V

5) LED

Cable colors

1) Brown

2) White

3) Blue

4) Black













5/2-directional valve, Series TC15

- Operating voltage 24 V DC
- 5/2
- Qn = 1500 l/min
- Pilot valve width : 15 mm
- Pipe connection
- Compressed air connection output : G 1/4
- Electrical connection : Plug, M8, 3-pin
- Manual override : with detent
- single solenoid double solenoid
- Pilot : Internal External



Version	Spool valve, positive overlapping
Activation	Electrically
Sealing principle	Soft sealing
Working pressure min./max.	See table below
Control pressure min./max.	See table below
Ambient temperature min./max.	-10 ... 50 °C
Medium temperature min./max.	-10 ... 50 °C
Medium	Compressed air
Max. particle size	5 µm
Oil content of compressed air	0 ... 5 mg/m ³
Nominal flow Qn	1500 l/min
Connector standard	DIN EN 60947-5-2
Protection class acc. to DIN EN 61140	Class III
Electrically	
Protection class with connection	IP65
LED status display	Yellow
Duty cycle	100 %
Mounting on manifold strip	P-strip
Mounting screw tightening torque	2.5 Nm
Weight	See table below
Comment	An example configuration is illustrated. The delivered product may thus deviate from the illustration.

Technical data

Part No.		MO	Compressed air connection	
			Input	Output
R422100986			G 1/4	G 1/4
R422100987			G 1/4	G 1/4
R422100988			G 1/4	G 1/4
R422100989			G 1/4	G 1/4
R422100990			G 1/4	G 1/4
R422100991			G 1/4	G 1/4

Part No.	Compressed air connection	
	Exhaust	Pilot Input
R422100986	G 1/4	-
R422100987	G 1/4	M5
R422100988	G 1/4	-
R422100989	G 1/4	M5
R422100990	G 1/4	-
R422100991	G 1/4	M5

Part No.	Operational voltage	Voltage tolerance	Power consumption	Pilot
R422100986	24 V	-10% / +10%	2.2 W	Internal
R422100987	24 V	-10% / +10%	2.2 W	External
R422100988	24 V	-10% / +10%	2.2 W	Internal
R422100989	24 V	-10% / +10%	2.2 W	External
R422100990	24 V	-10% / +10%	2.2 W	Internal
R422100991	24 V	-10% / +10%	2.2 W	External

Part No.	Flow conductance	Flow conductance	Nominal resistance	Working pressure min./max.
	b	C-value		
R422100986	0.33	6.8 l/(s*bar)	280 Ω	2.5 ... 10 bar
R422100987	0.33	6.8 l/(s*bar)	280 Ω	-0.9 ... 10 bar
R422100988	0.33	6.8 l/(s*bar)	280 Ω	3 ... 10 bar
R422100989	0.33	6.8 l/(s*bar)	280 Ω	-0.9 ... 10 bar
R422100990	0.33	6.8 l/(s*bar)	280 Ω	2 ... 10 bar
R422100991	0.33	6.8 l/(s*bar)	280 Ω	-0.9 ... 10 bar

Part No.	Control pressure min./max.	Typ. switch-on time	Typ. switch-off time	Weight
R422100986	2.5 ... 10 bar	21 ms	22 ms	0.235 kg
R422100987	2.5 ... 10 bar	21 ms	22 ms	0.235 kg
R422100988	3 ... 10 bar	12 ms	35 ms	0.235 kg
R422100989	3 ... 10 bar	12 ms	35 ms	0.235 kg
R422100990	2 ... 10 bar	10 ms	10 ms	0.265 kg
R422100991	2 ... 10 bar	10 ms	10 ms	0.265 kg

Nominal flow Q_n at 6 bar and $\Delta p = 1$ bar, MO = Manual override

Technical information

The min. control pressure must be adhered to, since otherwise faulty switching and valve failure may result!

The pressure dew point must be at least 15 °C under ambient and medium temperature and may not exceed 3 °C .

The oil content of compressed air must remain constant during the life cycle.

Use only the approved oils from AVENTICS. Further information can be found in the "Technical information" document (available in the MediaCentre).

Technical information

Material	
Housing	Polyamide fiber-glass reinforced
Seals	Acrylonitrile butadiene rubber Hydrogenated nitrile butadiene rubber
Front plate	Polyamide fiber-glass reinforced
Threaded bushing	Brass Die cast zinc, nickel-plated chrome-plated

Dimensions

Dimensions, single solenoid

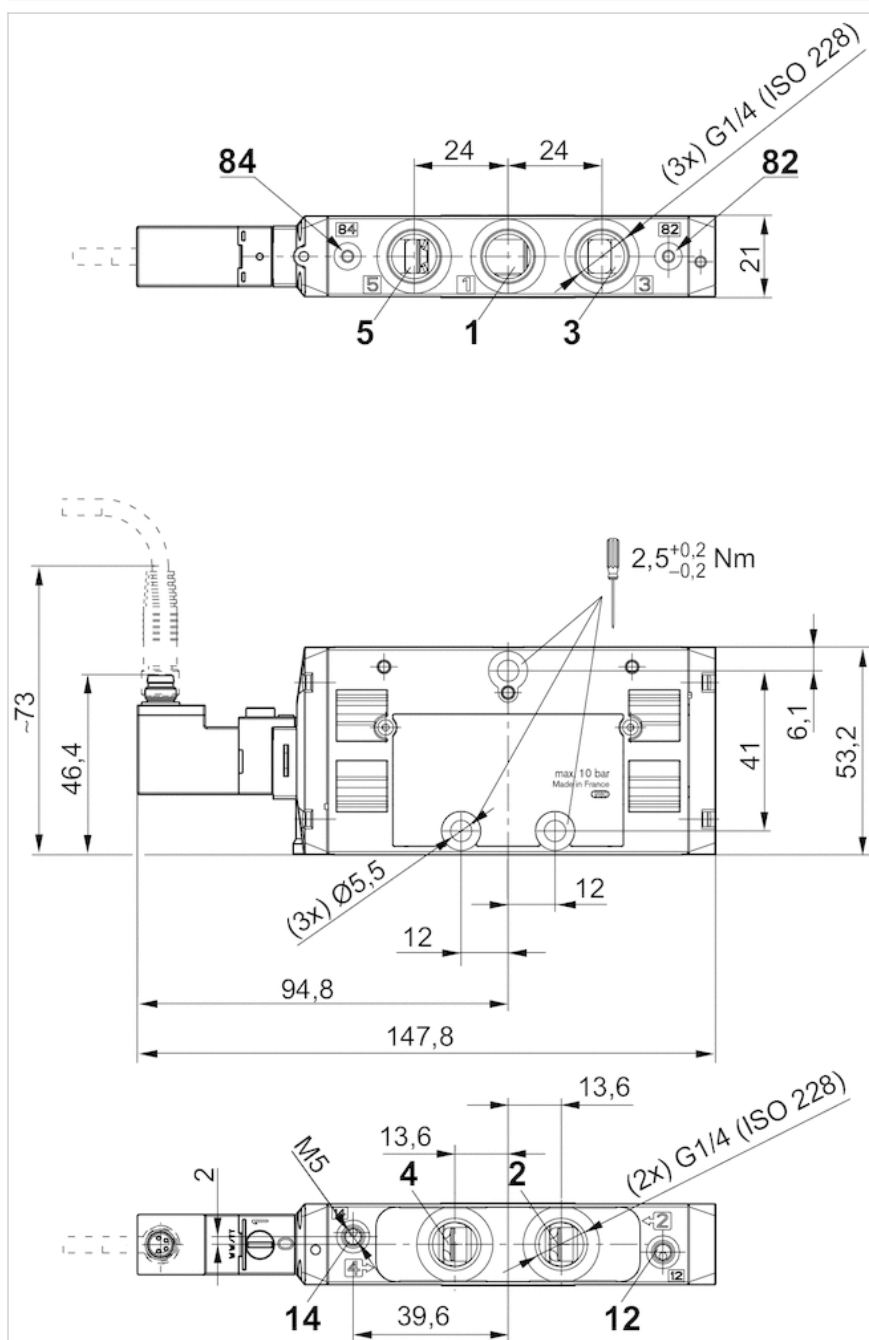

Dimensions, double solenoid

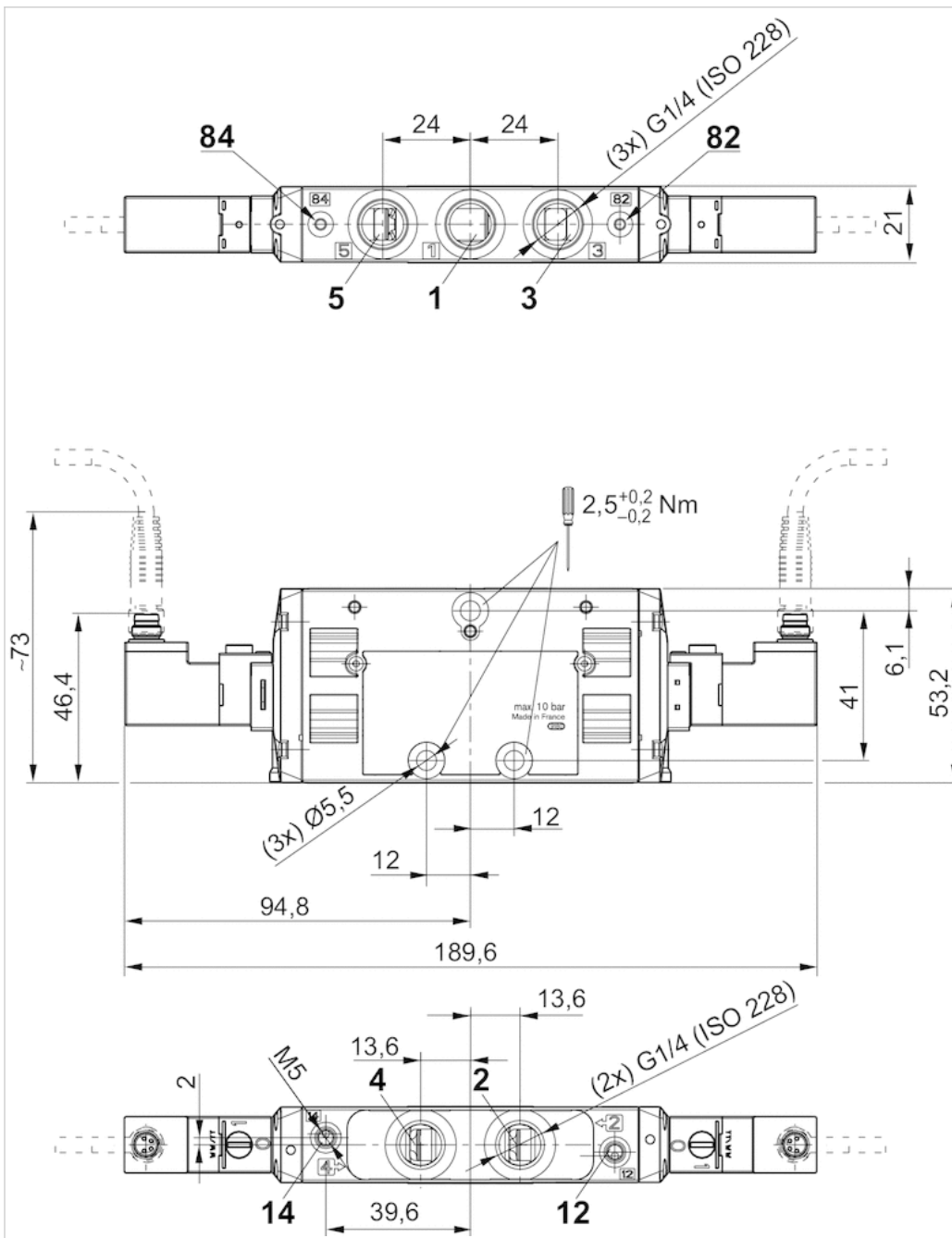

Pin assignments

PIN assignment and cable colors for valve plug connectors

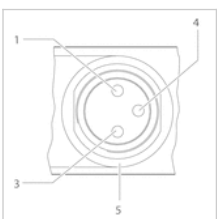

- PIN assignment:
- 1) PIN not assigned
 - 3) 0 V
 - 4) 24 V

5) LED

Cable color

1) Brown

3) Blue

4) Black

Note: Bi-polar protective circuit to prevent overvoltage













5/2-directional valve, Series TC15

- Operating voltage 24 V DC
- 5/2
- Qn = 1500 l/min
- Pilot valve width : 15 mm
- Pipe connection
- Compressed air connection output : G 1/4
- Electrical connection : Plug, M8, 4-pin
- Manual override : without detent
- single solenoid double solenoid
- Pilot : Internal External



Version	Spool valve, positive overlapping
Activation	Electrically
Sealing principle	Soft sealing
Working pressure min./max.	See table below
Control pressure min./max.	See table below
Ambient temperature min./max.	-10 ... 50 °C
Medium temperature min./max.	-10 ... 50 °C
Medium	Compressed air
Max. particle size	5 µm
Oil content of compressed air	0 ... 5 mg/m ³
Nominal flow Qn	1500 l/min
Connector standard	DIN EN 60947-5-2
Protection class acc. to DIN EN 61140 Electrically	Class III
Protection class with connection	IP65
LED status display	Yellow
Duty cycle	100 %
Mounting on manifold strip	P-strip
Mounting screw tightening torque	2.5 Nm
Weight	See table below
Comment	An example configuration is illustrated. The delivered product may thus deviate from the illustration.

Technical data

Part No.		MO	Compressed air connection	
			Input	Output
0820058301			G 1/4	G 1/4
0820058351			G 1/4	G 1/4
0820058311			G 1/4	G 1/4
0820058361			G 1/4	G 1/4
0820058321			G 1/4	G 1/4
0820058371			G 1/4	G 1/4

Part No.	Compressed air connection	
	Exhaust	Pilot Input
0820058301	G 1/4	-
0820058351	G 1/4	M5
0820058311	G 1/4	-
0820058361	G 1/4	M5
0820058321	G 1/4	-
0820058371	G 1/4	M5

Part No.	Operational voltage	Voltage tolerance	Power consumption	Pilot
0820058301	24 V	-10% / +10%	2.2 W	Internal
0820058351	24 V	-10% / +10%	2.2 W	External
0820058311	24 V	-10% / +10%	2.2 W	Internal
0820058361	24 V	-10% / +10%	2.2 W	External
0820058321	24 V	-10% / +10%	2.2 W	Internal
0820058371	24 V	-10% / +10%	2.2 W	External

Part No.	Flow conductance	Flow conductance	Nominal resistance	Working pressure min./max.
	b	C-value		
0820058301	0.33	6.8 l/(s*bar)	280 Ω	2.5 ... 10 bar
0820058351	0.33	6.8 l/(s*bar)	280 Ω	-0.9 ... 10 bar
0820058311	0.33	6.8 l/(s*bar)	280 Ω	3 ... 10 bar
0820058361	0.33	6.8 l/(s*bar)	280 Ω	-0.9 ... 10 bar
0820058321	0.33	6.8 l/(s*bar)	280 Ω	2 ... 10 bar
0820058371	0.33	6.8 l/(s*bar)	280 Ω	-0.9 ... 10 bar

Part No.	Control pressure min./max.	Typ. switch-on time	Typ. switch-off time	Weight
0820058301	2.5 ... 10 bar	21 ms	22 ms	0.235 kg
0820058351	2.5 ... 10 bar	21 ms	22 ms	0.235 kg
0820058311	3 ... 10 bar	12 ms	35 ms	0.235 kg
0820058361	3 ... 10 bar	12 ms	35 ms	0.235 kg
0820058321	2 ... 10 bar	10 ms	10 ms	0.265 kg
0820058371	2 ... 10 bar	10 ms	10 ms	0.265 kg

Nominal flow Q_n at 6 bar and Δp = 1 bar, MO = Manual override

Technical information

The min. control pressure must be adhered to, since otherwise faulty switching and valve failure may result!

The pressure dew point must be at least 15 °C under ambient and medium temperature and may not exceed 3 °C .

The oil content of compressed air must remain constant during the life cycle.

Use only the approved oils from AVENTICS. Further information can be found in the "Technical information" document (available in the MediaCentre).

Technical information

Material	
Housing	Polyamide fiber-glass reinforced
Seals	Acrylonitrile butadiene rubber Hydrogenated nitrile butadiene rubber
Front plate	Polyamide fiber-glass reinforced
Threaded bushing	Brass Die cast zinc, nickel-plated chrome-plated

Dimensions

Dimensions, single solenoid

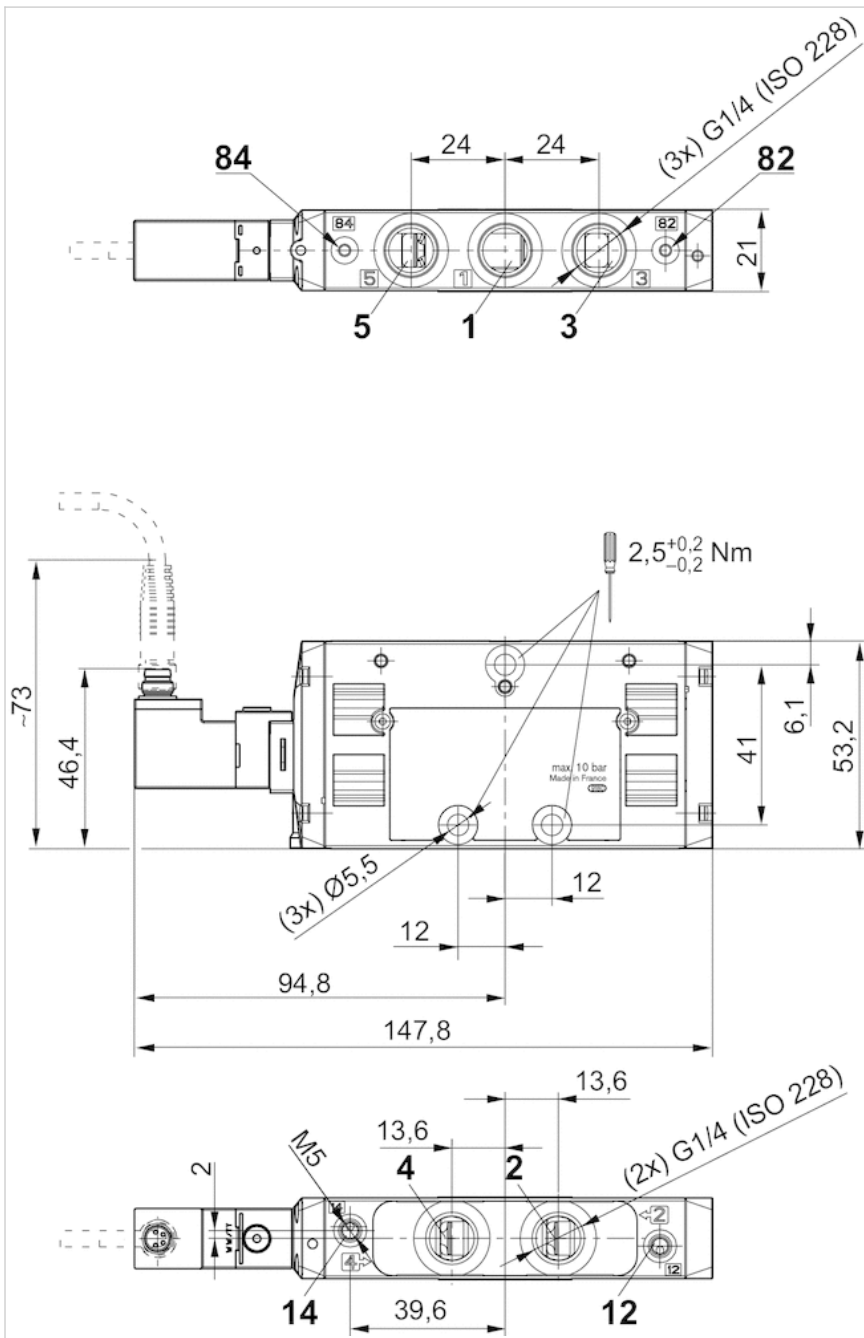

Dimensions, double solenoid

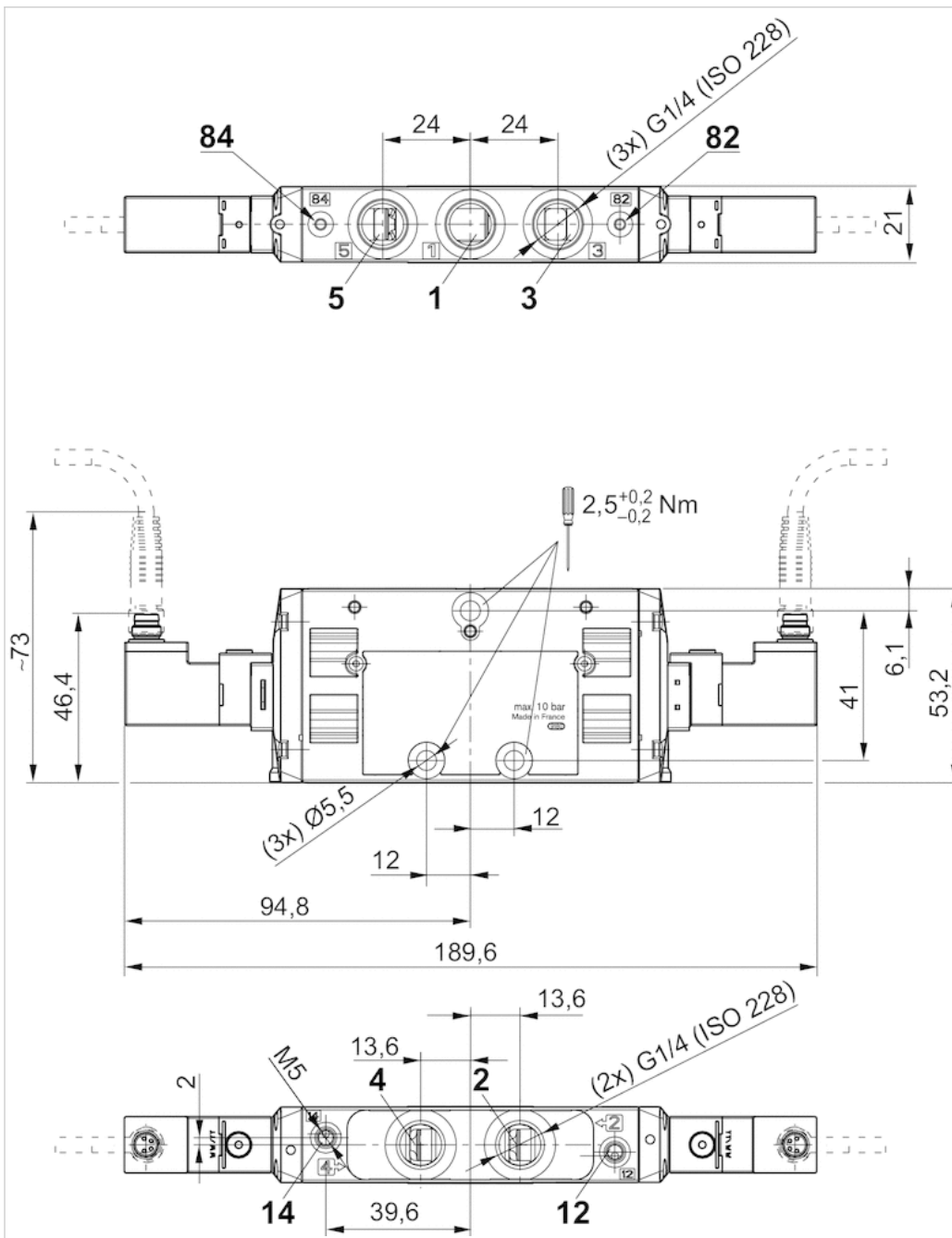

Pin assignments

PIN assignment and cable colors for valve plug connectors

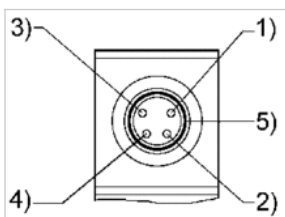

PIN assignment:

- 1) PIN not assigned
- 2) PIN not assigned
- 3) 0 V

4) 24 V

5) LED

Cable colors

1) Brown

2) White

3) Blue

4) Black











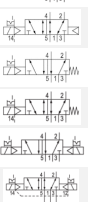

5/2-directional valve, Series TC15

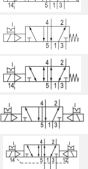
- Operating voltage 24 V DC
- 5/2
- Qn = 1500 l/min
- Pilot valve width : 15 mm
- Pipe connection
- Compressed air connection output : G 1/4
- Electrical connection : Plug, M8, 4-pin
- Manual override : with detent
- single solenoid double solenoid
- Pilot : Internal External

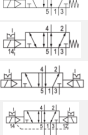

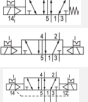
Version	Spool valve, positive overlapping
Activation	Electrically
Sealing principle	Soft sealing
Working pressure min./max.	See table below
Control pressure min./max.	See table below
Ambient temperature min./max.	-10 ... 50 °C
Medium temperature min./max.	-10 ... 50 °C
Medium	Compressed air
Max. particle size	5 µm
Oil content of compressed air	0 ... 5 mg/m ³
Nominal flow Qn	1500 l/min
Connector standard	DIN EN 60947-5-2
Protection class acc. to DIN EN 61140 Electrically	Class III
Protection class with connection	IP65
LED status display	Yellow
Duty cycle	100 %
Mounting on manifold strip	P-strip
Mounting screw tightening torque	2.5 Nm
Weight	See table below
Comment	An example configuration is illustrated. The delivered product may thus deviate from the illustration.

Technical data

Part No.		MO	Compressed air connection	
			Input	Output
0820058201			G 1/4	G 1/4
0820058251			G 1/4	G 1/4
0820058211			G 1/4	G 1/4
0820058261			G 1/4	G 1/4
0820058221			G 1/4	G 1/4
0820058271			G 1/4	G 1/4

Part No.	Compressed air connection	
	Exhaust	Pilot Input
0820058201	G 1/4	-
0820058251	G 1/4	M5
0820058211	G 1/4	-
0820058261	G 1/4	M5
0820058221	G 1/4	-
0820058271	G 1/4	M5

Part No.	Operational voltage	Voltage tolerance	Power consumption	Pilot
0820058201	24 V	-10% / +10%	2.2 W	Internal
0820058251	24 V	-10% / +10%	2.2 W	External
0820058211	24 V	-10% / +10%	2.2 W	Internal
0820058261	24 V	-10% / +10%	2.2 W	External
0820058221	24 V	-10% / +10%	2.2 W	Internal
0820058271	24 V	-10% / +10%	2.2 W	External

Part No.	Flow conductance	Flow conductance	Nominal resistance	Working pressure min./max.
	b	C-value		
0820058201	0.33	6.8 l/(s*bar)	280 Ω	2.5 ... 10 bar
0820058251	0.33	6.8 l/(s*bar)	280 Ω	-0.9 ... 10 bar
0820058211	0.33	6.8 l/(s*bar)	280 Ω	3 ... 10 bar
0820058261	0.33	6.8 l/(s*bar)	280 Ω	-0.9 ... 10 bar
0820058221	0.33	6.8 l/(s*bar)	280 Ω	2 ... 10 bar
0820058271	0.33	6.8 l/(s*bar)	280 Ω	-0.9 ... 10 bar

Part No.	Control pressure min./max.	Typ. switch-on time	Typ. switch-off time	Weight
0820058201	2.5 ... 10 bar	21 ms	22 ms	0.235 kg
0820058251	2.5 ... 10 bar	21 ms	22 ms	0.235 kg
0820058211	3 ... 10 bar	12 ms	35 ms	0.235 kg
0820058261	3 ... 10 bar	12 ms	35 ms	0.235 kg
0820058221	2 ... 10 bar	10 ms	10 ms	0.265 kg
0820058271	2 ... 10 bar	10 ms	10 ms	0.265 kg

Nominal flow Q_n at 6 bar and Δp = 1 bar, MO = Manual override

Technical information

The min. control pressure must be adhered to, since otherwise faulty switching and valve failure may result!

The pressure dew point must be at least 15 °C under ambient and medium temperature and may not exceed 3 °C .

The oil content of compressed air must remain constant during the life cycle.

Use only the approved oils from AVENTICS. Further information can be found in the "Technical information" document (available in the MediaCentre).

Technical information

Material	
Housing	Polyamide fiber-glass reinforced
Seals	Acrylonitrile butadiene rubber Hydrogenated nitrile butadiene rubber
Front plate	Polyamide fiber-glass reinforced
Threaded bushing	Brass Die cast zinc, nickel-plated chrome-plated

Dimensions

Dimensions, single solenoid

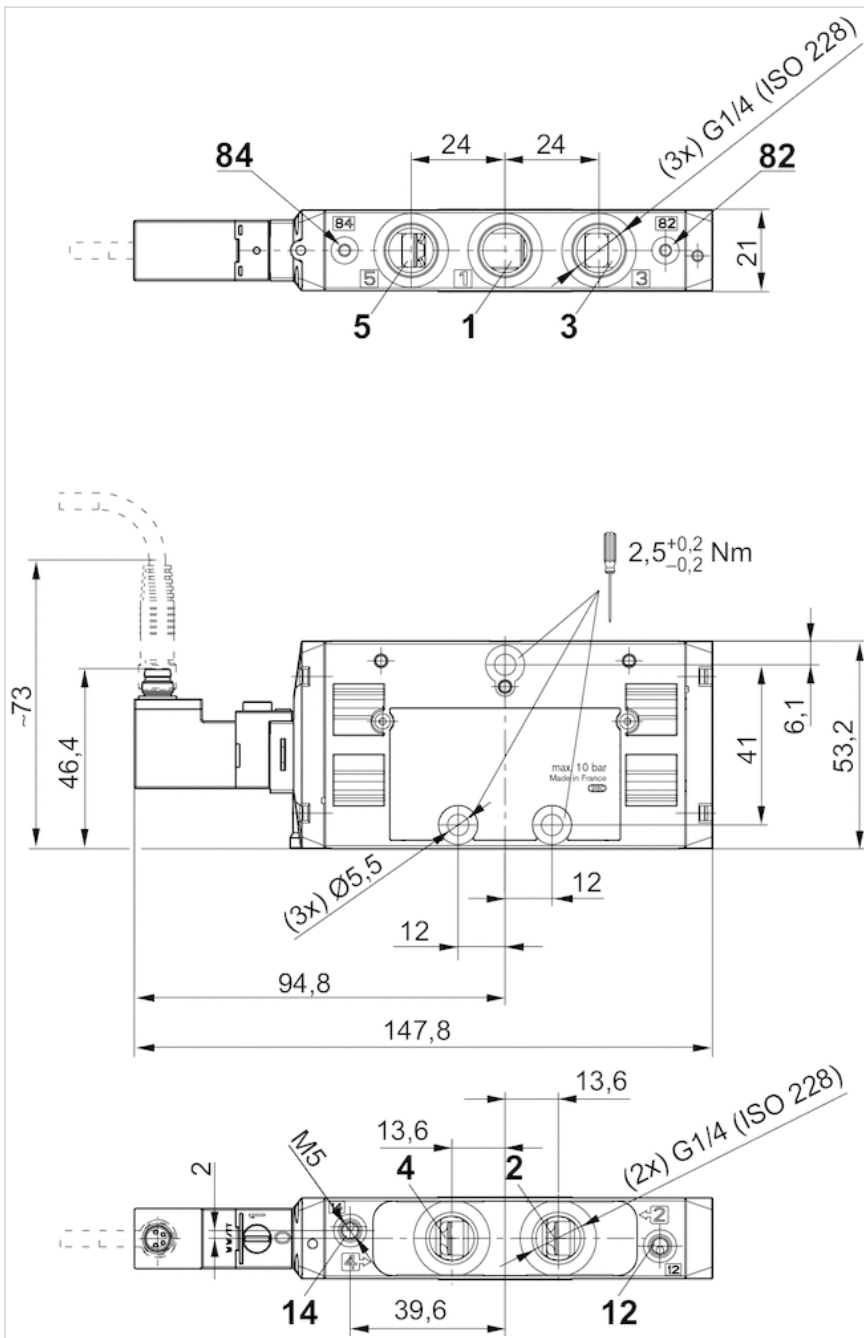

Dimensions, double solenoid

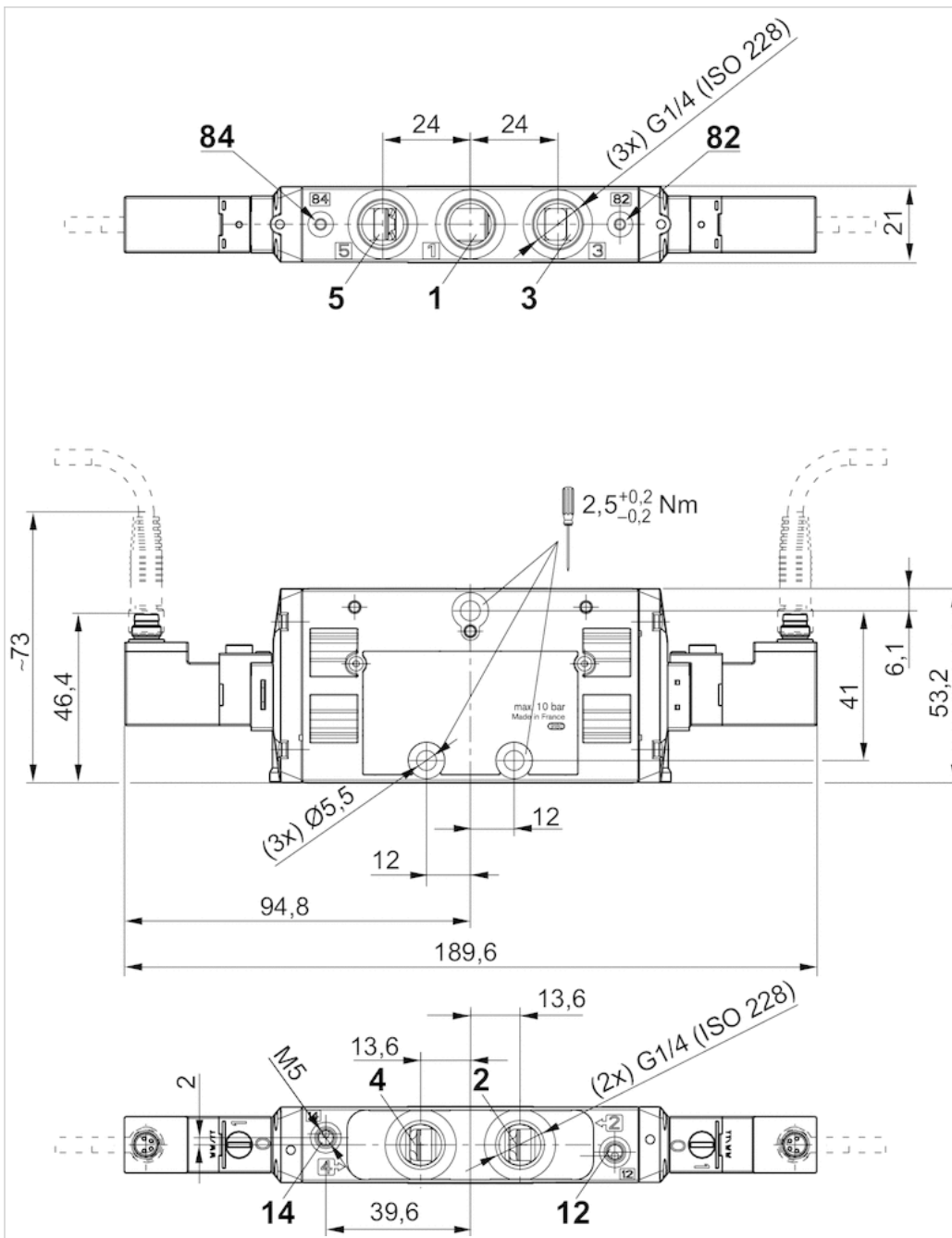

Pin assignments

PIN assignment and cable colors for valve plug connectors

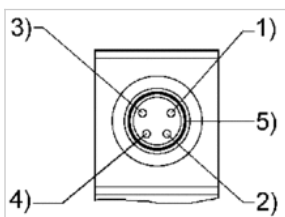

- PIN assignment:
- 1) PIN not assigned
 - 2) PIN not assigned
 - 3) 0 V

4) 24 V

5) LED

Cable colors

1) Brown

2) White

3) Blue

4) Black











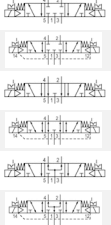
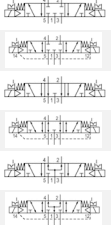

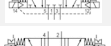
5/3-directional valve, Series TC15

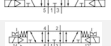
- Operating voltage 24 V DC
- 5/3
- Qn = 1300 l/min
- Pilot valve width : 15 mm
- closed center exhausted center pressurized center
- Pipe connection
- Compressed air connection output : G 1/4
- Electrical connection : Plug, M8, 3-pin
- Manual override : with detent
- double solenoid
- Pilot : Internal External



Version	Spool valve, positive overlapping
Activation	Electrically
Sealing principle	Soft sealing
Working pressure min./max.	See table below
Control pressure min./max.	3 ... 10 bar
Ambient temperature min./max.	-10 ... 50 °C
Medium temperature min./max.	-10 ... 50 °C
Medium	Compressed air
Max. particle size	5 µm
Oil content of compressed air	0 ... 5 mg/m ³
Nominal flow Qn	1300 l/min
Connector standard	DIN EN 60947-5-2
Protection class acc. to DIN EN 61140 Electrically	Class III
Protection class with connection	IP65
LED status display	Yellow
Duty cycle	100 %
Typ. switch-on time	12 ms
Typ. switch-off time	13 ms
Mounting on manifold strip	P-strip
Mounting screw tightening torque	2.5 Nm
Weight	0.279 kg

Technical data

Part No.		MO		Compressed air connection	
					Input
R422100992				closed center	G 1/4
R422100993				closed center	G 1/4
R422100994				exhausted center	G 1/4
R422100995				exhausted center	G 1/4
R422100996				pressurized center	G 1/4
R422100997				pressurized center	G 1/4

Part No.	Compressed air connection	
	Output	Exhaust
R422100992	G 1/4	G 1/4
R422100993	G 1/4	G 1/4
R422100994	G 1/4	G 1/4
R422100995	G 1/4	G 1/4
R422100996	G 1/4	G 1/4
R422100997	G 1/4	G 1/4

Part No.	Compressed air connection		Operational voltage	Voltage tolerance
		Pilot Input		
R422100992	-	-	24 V	-10% / +10%
R422100993	M5	M5	24 V	-10% / +10%
R422100994	-	-	24 V	-10% / +10%
R422100995	M5	M5	24 V	-10% / +10%
R422100996	-	-	24 V	-10% / +10%
R422100997	M5	M5	24 V	-10% / +10%

Part No.	Power consumption		Pilot	Flow conductance		Nominal resistance
	DC			b	C-value	
R422100992	2.2 W		Internal	0.31	5.9 l/(s*bar)	280 Ω
R422100993	2.2 W		External	0.31	5.9 l/(s*bar)	280 Ω
R422100994	2.2 W		Internal	0.31	5.9 l/(s*bar)	280 Ω
R422100995	2.2 W		External	0.31	5.9 l/(s*bar)	280 Ω
R422100996	2.2 W		Internal	0.31	5.9 l/(s*bar)	280 Ω
R422100997	2.2 W		External	0.31	5.9 l/(s*bar)	280 Ω

Part No.	Working pressure min./max.
R422100992	3 ... 10 bar
R422100993	-0.9 ... 10 bar
R422100994	3 ... 10 bar
R422100995	-0.9 ... 10 bar
R422100996	3 ... 10 bar
R422100997	-0.9 ... 10 bar

Nominal flow Q_n at 6 bar and Δp = 1 bar, MO = Manual override

Technical information

The min. control pressure must be adhered to, since otherwise faulty switching and valve failure may result!

The pressure dew point must be at least 15 °C under ambient and medium temperature and may not exceed 3 °C .

The oil content of compressed air must remain constant during the life cycle.

Use only the approved oils from AVENTICS. Further information can be found in the "Technical information" document (available in the MediaCentre).

Technical information

Material	
Housing	Polyamide fiber-glass reinforced
Seals	Acrylonitrile butadiene rubber Hydrogenated nitrile butadiene rubber
Front plate	Polyamide fiber-glass reinforced
Threaded bushing	Brass Die cast zinc, nickel-plated chrome-plated

Dimensions

Dimensions

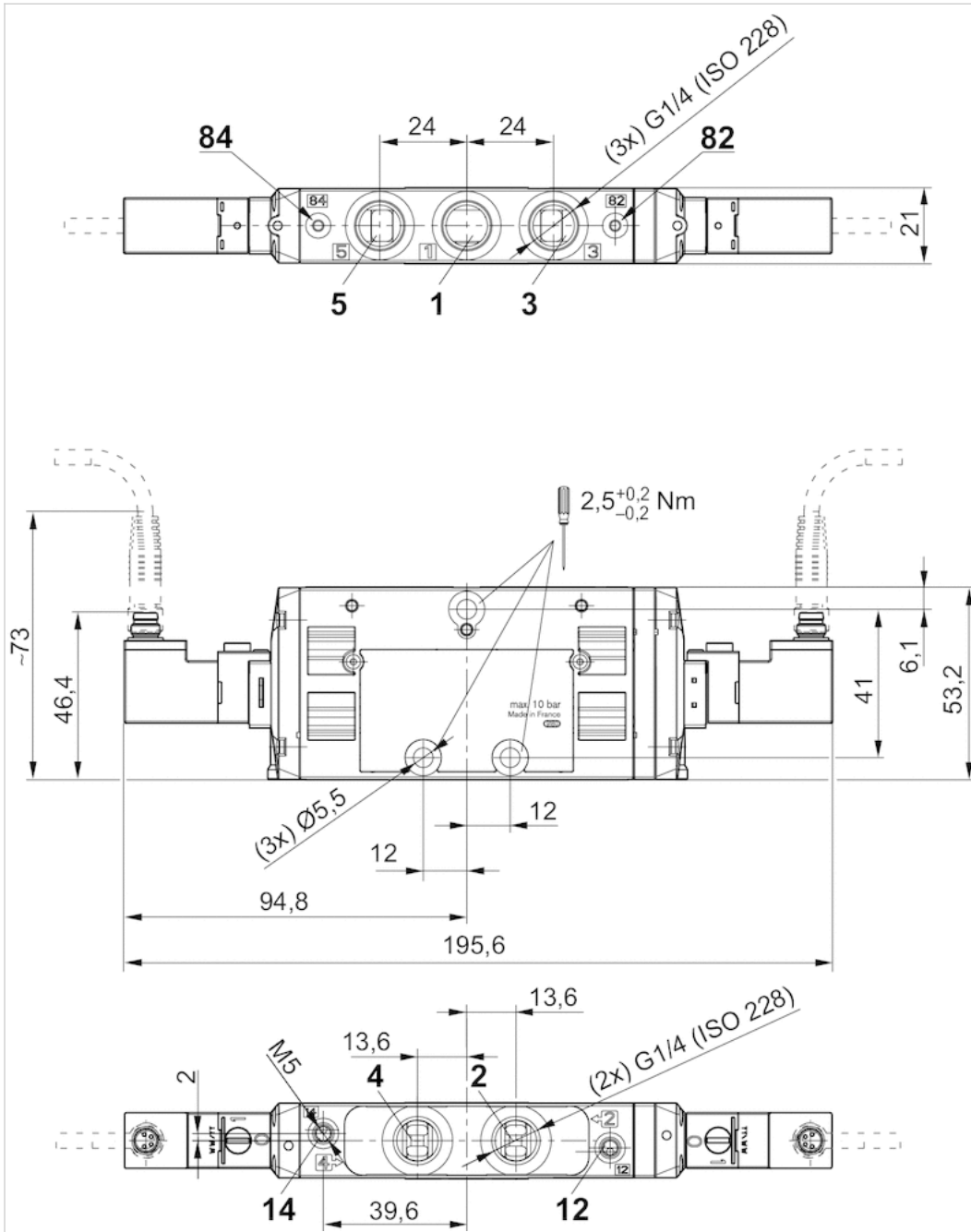

Pin assignments

PIN assignment and cable colors for valve plug connectors

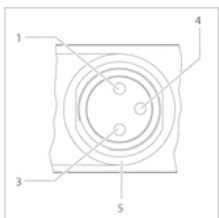

PIN assignment:
1) PIN not assigned

- 3) 0 V
- 4) 24 V
- 5) LED

Cable color

- 1) Brown
- 3) Blue
- 4) Black

Note: Bi-polar protective circuit to prevent overvoltage

5/3-directional valve, Series TC15

- Operating voltage 24 V DC
- 5/3
- $Q_n = 1300$ l/min
- Pilot valve width : 15 mm
- closed center exhausted center pressurized center
- Pipe connection
- Compressed air connection output : G 1/4
- Electrical connection : Plug, M8, 4-pin
- Manual override : without detent
- double solenoid
- Pilot : Internal External



Version	Spool valve, positive overlapping
Activation	Electrically
Sealing principle	Soft sealing
Working pressure min./max.	See table below
Control pressure min./max.	3 ... 10 bar
Ambient temperature min./max.	-10 ... 50 °C
Medium temperature min./max.	-10 ... 50 °C
Medium	Compressed air
Max. particle size	5 µm
Oil content of compressed air	0 ... 5 mg/m ³
Nominal flow Q_n	1300 l/min
Connector standard	DIN EN 60947-5-2
Protection class acc. to DIN EN 61140	Class III
Electrically	
Protection class with connection	IP65
LED status display	Yellow
Duty cycle	100 %
Typ. switch-on time	12 ms
Typ. switch-off time	13 ms
Mounting on manifold strip	P-strip
Mounting screw tightening torque	2.5 Nm
Weight	0.279 kg

Technical data

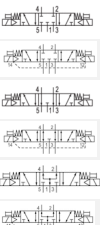
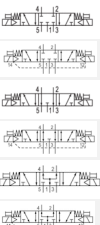
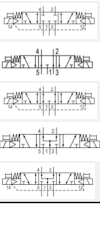
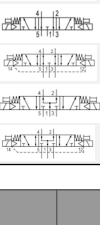
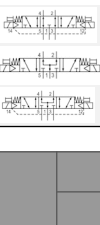
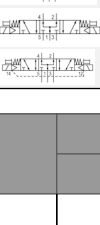
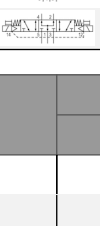
Part No.		MO	Compressed air connection	
				Input
0820059301		closed center		G 1/4
0820059351		closed center		G 1/4
0820059311		exhausted center		G 1/4
0820059361		exhausted center		G 1/4
0820059321		pressurized center		G 1/4
0820059371		pressurized center		G 1/4

Part No.	Compressed air connection	Compressed air connection
	Output	Exhaust
0820059301	G 1/4	G 1/4
0820059351	G 1/4	G 1/4
0820059311	G 1/4	G 1/4
0820059361	G 1/4	G 1/4
0820059321	G 1/4	G 1/4
0820059371	G 1/4	G 1/4

Part No.	Compressed air connection	Operational voltage	Voltage tolerance
	Pilot Input	DC	DC
0820059301	-	24 V	-10% / +10%
0820059351	M5	24 V	-10% / +10%
0820059311	-	24 V	-10% / +10%
0820059361	M5	24 V	-10% / +10%
0820059321	-	24 V	-10% / +10%
0820059371	M5	24 V	-10% / +10%

Part No.	Power consumption	Pilot	Flow conductance	Flow conductance	Nominal resistance
	DC		b	C-value	
0820059301	2.2 W	Internal	0.31	5.9 l/(s*bar)	280 Ω
0820059351	2.2 W	External	0.31	5.9 l/(s*bar)	280 Ω
0820059311	2.2 W	Internal	0.31	5.9 l/(s*bar)	280 Ω
0820059361	2.2 W	External	0.31	5.9 l/(s*bar)	280 Ω
0820059321	2.2 W	Internal	0.31	5.9 l/(s*bar)	280 Ω
0820059371	2.2 W	External	0.31	5.9 l/(s*bar)	280 Ω

Part No.	Working pressure min./max.
0820059301	3 ... 10 bar
0820059351	-0.9 ... 10 bar
0820059311	3 ... 10 bar
0820059361	-0.9 ... 10 bar
0820059321	3 ... 10 bar
0820059371	-0.9 ... 10 bar

Nominal flow Q_n at 6 bar and Δp = 1 bar, MO = Manual override

Technical information

The min. control pressure must be adhered to, since otherwise faulty switching and valve failure may result!

The pressure dew point must be at least 15 °C under ambient and medium temperature and may not exceed 3 °C .

The oil content of compressed air must remain constant during the life cycle.

Use only the approved oils from AVENTICS. Further information can be found in the "Technical information" document (available in the MediaCentre).

Technical information

Material	
Housing	Polyamide fiber-glass reinforced
Seals	Acrylonitrile butadiene rubber Hydrogenated nitrile butadiene rubber
Front plate	Polyamide fiber-glass reinforced
Threaded bushing	Brass Die cast zinc, nickel-plated chrome-plated

Dimensions

Dimensions

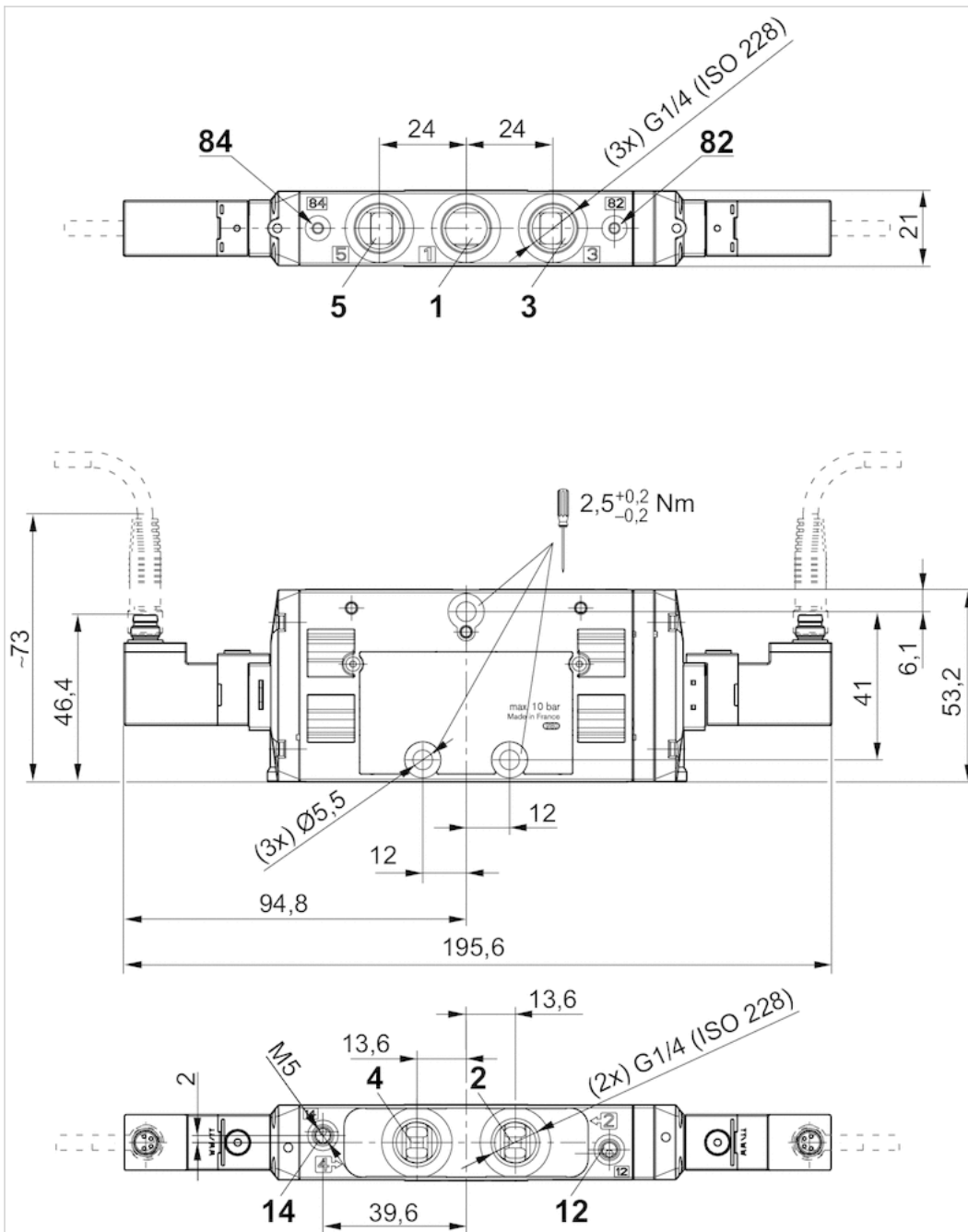

Pin assignments

PIN assignment and cable colors for valve plug connectors

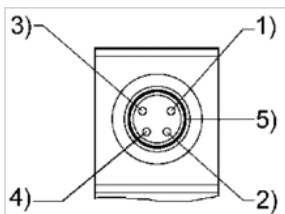

PIN assignment:
1) PIN not assigned

2) PIN not assigned

3) 0 V

4) 24 V

5) LED

Cable colors

1) Brown

2) White

3) Blue

4) Black











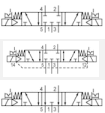

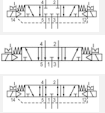
5/3-directional valve, Series TC15

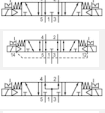
- Operating voltage 24 V DC
- 5/3
- $Q_n = 1300$ l/min
- Pilot valve width : 15 mm
- closed center exhausted center pressurized center
- Pipe connection
- Compressed air connection output : G 1/4
- Electrical connection : Plug, M8, 4-pin
- Manual override : with detent
- double solenoid
- Pilot : Internal External

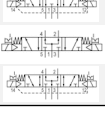

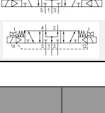
Version	Spool valve, positive overlapping
Activation	Electrically
Sealing principle	Soft sealing
Working pressure min./max.	See table below
Control pressure min./max.	3 ... 10 bar
Ambient temperature min./max.	-10 ... 50 °C
Medium temperature min./max.	-10 ... 50 °C
Medium	Compressed air
Max. particle size	5 µm
Oil content of compressed air	0 ... 5 mg/m ³
Nominal flow Q_n	1300 l/min
Connector standard	DIN EN 60947-5-2
Protection class acc. to DIN EN 61140 Electrically	Class III
Protection class with connection	IP65
LED status display	Yellow
Duty cycle	100 %
Typ. switch-on time	12 ms
Typ. switch-off time	13 ms
Mounting on manifold strip	P-strip
Mounting screw tightening torque	2.5 Nm
Weight	0.279 kg

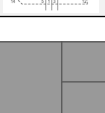
Technical data

Part No.		MO	Compressed air connection	
				Input
0820059201			closed center	G 1/4
0820059251			closed center	G 1/4
0820059211			exhausted center	G 1/4
0820059261			exhausted center	G 1/4
0820059221			pressurized center	G 1/4
0820059271			pressurized center	G 1/4

Part No.	Compressed air connection	Compressed air connection
	Output	Exhaust
0820059201	G 1/4	G 1/4
0820059251	G 1/4	G 1/4
0820059211	G 1/4	G 1/4
0820059261	G 1/4	G 1/4
0820059221	G 1/4	G 1/4
0820059271	G 1/4	G 1/4

Part No.	Compressed air connection	Operational voltage	Voltage tolerance
	Pilot Input	DC	DC
0820059201	-	24 V	-10% / +10%
0820059251	M5	24 V	-10% / +10%
0820059211	-	24 V	-10% / +10%
0820059261	M5	24 V	-10% / +10%
0820059221	-	24 V	-10% / +10%
0820059271	M5	24 V	-10% / +10%

Part No.	Power consumption	Pilot	Flow conductance	Flow conductance	Nominal resistance
	DC		b	C-value	
0820059201	2.2 W	Internal	0.31	5.9 l/(s*bar)	280 Ω
0820059251	2.2 W	External	0.31	5.9 l/(s*bar)	280 Ω
0820059211	2.2 W	Internal	0.31	5.9 l/(s*bar)	280 Ω
0820059261	2.2 W	External	0.31	5.9 l/(s*bar)	280 Ω
0820059221	2.2 W	Internal	0.31	5.9 l/(s*bar)	280 Ω
0820059271	2.2 W	External	0.31	5.9 l/(s*bar)	280 Ω

Part No.	Working pressure min./max.	push-in fitting
0820059201	3 ... 10 bar	Brass Die cast zinc nickel-plated chrome-plated
0820059251	-0.9 ... 10 bar	Brass Die cast zinc nickel-plated chrome-plated
0820059211	3 ... 10 bar	Brass Die cast zinc nickel-plated chrome-plated
0820059261	-0.9 ... 10 bar	Brass Die cast zinc nickel-plated chrome-plated
0820059221	3 ... 10 bar	Brass Die cast zinc nickel-plated chrome-plated
0820059271	-0.9 ... 10 bar	-

Nominal flow Q_n at 6 bar and $\Delta p = 1$ bar, MO = Manual override

Technical information

The min. control pressure must be adhered to, since otherwise faulty switching and valve failure may result!

The pressure dew point must be at least 15 °C under ambient and medium temperature and may not exceed 3 °C .

The oil content of compressed air must remain constant during the life cycle.

Use only the approved oils from AVENTICS. Further information can be found in the "Technical information" document (available in the MediaCentre).

Technical information

Material	
Housing	Polyamide fiber-glass reinforced
Seals	Acrylonitrile butadiene rubber Hydrogenated nitrile butadiene rubber
Front plate	Polyamide fiber-glass reinforced
Threaded bushing	Brass Die cast zinc, nickel-plated chrome-plated

Dimensions

Dimensions

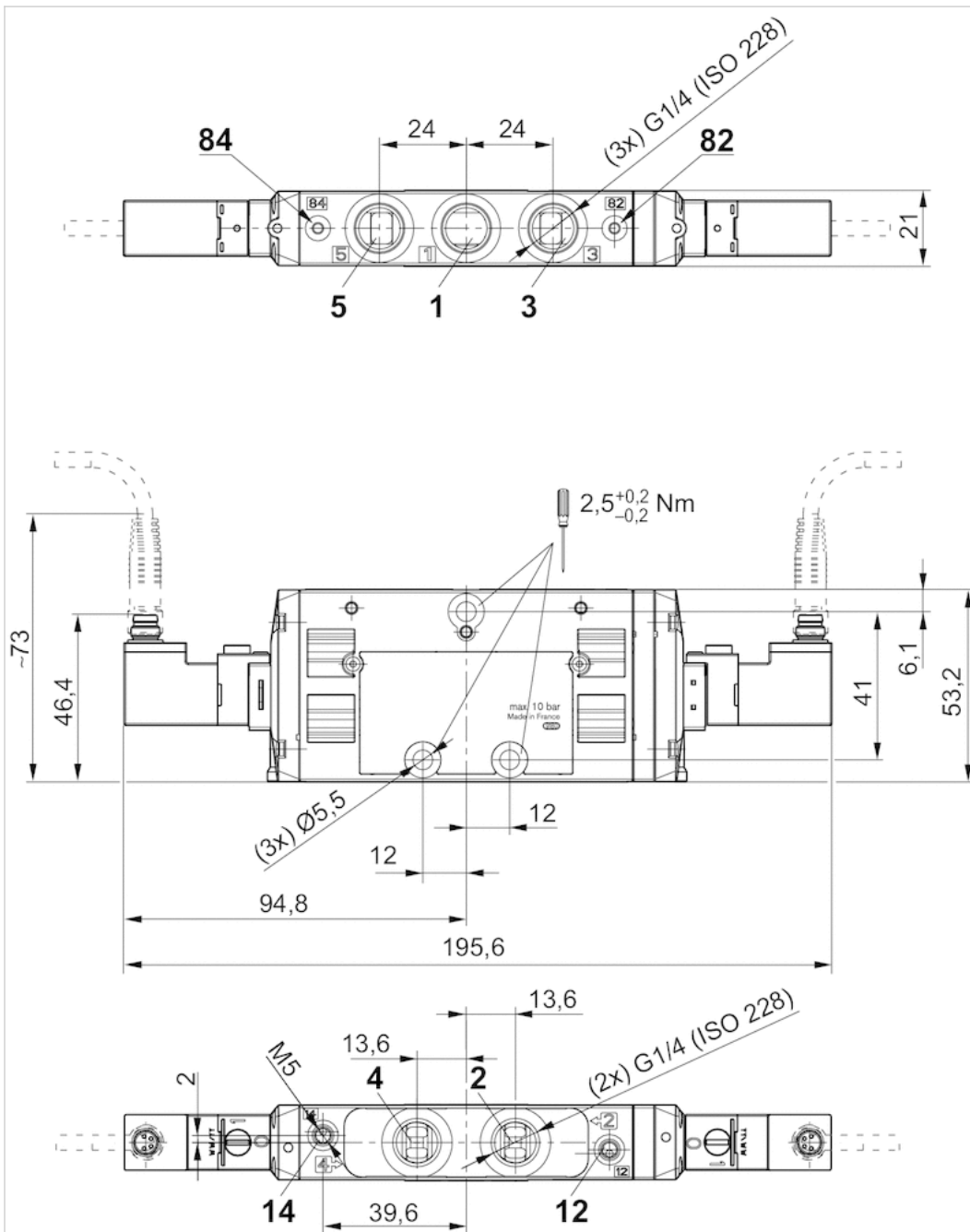

Pin assignments

PIN assignment and cable colors for valve plug connectors

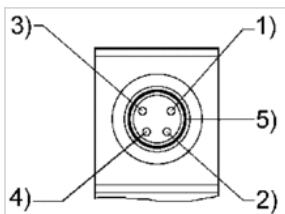

PIN assignment:
1) PIN not assigned

2) PIN not assigned

3) 0 V

4) 24 V

5) LED

Cable colors

1) Brown

2) White

3) Blue

4) Black













2x3/2-directional valve, Series TC15

- Operating voltage 24 V DC
- 2x3/2
- Qn = 1100 l/min
- Pilot valve width : 15 mm
- NC/NC NO/NO NC/NO
- Pipe connection
- Compressed air connection output : G 1/4
- Electrical connection : Plug, ISO 15217, form C
- Manual override : without detent
- double solenoid
- With spring return
- Pilot : External, Internal



Version	Spool valve, positive overlapping
Activation	Electrically
Pilot	External, Internal
Sealing principle	Soft sealing
Working pressure min./max.	See table below
Control pressure min./max.	3 ... 10 bar
Ambient temperature min./max.	-10 ... 50 °C
Medium temperature min./max.	-10 ... 50 °C
Medium	Compressed air
Max. particle size	5 µm
Oil content of compressed air	0 ... 5 mg/m ³
Nominal flow Qn	1100 l/min
Compressed air connection	according to ISO 228-1
Connector standard	ISO 15217
Protection class with connection	IP65
Duty cycle	100 %
Typ. switch-on time	12 ms
Typ. switch-off time	16 ms
Generic emission standard in accordance with	EN 50081-2:1993
Mounting on manifold strip	P-strip
Mounting screw tightening torque	2.5 Nm
Tightening torque tolerance	±0,2 mT
Weight	0.278 kg

Technical data

Part No.		MO	Compressed air connection		
				Input	
R422102158				NC/NC	G 1/4
R422102162				NO/NO	G 1/4
R422102166				NC/NO	G 1/4
R422102169				NC/NC	G 1/4
R422102172				NO/NO	G 1/4
R422102175				NC/NO	G 1/4

Part No.	Compressed air connection	
	Output	Exhaust
R422102158	G 1/4	G 1/4
R422102162	G 1/4	G 1/4
R422102166	G 1/4	G 1/4
R422102169	G 1/4	G 1/4
R422102172	G 1/4	G 1/4
R422102175	G 1/4	G 1/4

Part No.	Compressed air connection		Operational voltage	Voltage tolerance
		Pilot Input		
R422102158	-	-	24 V	-10% / +10%
R422102162	-	-	24 V	-10% / +10%
R422102166	-	-	24 V	-10% / +10%
R422102169	M5	M5	24 V	-10% / +10%
R422102172	M5	M5	24 V	-10% / +10%
R422102175	M5	M5	24 V	-10% / +10%

Part No.	Power consumption	Flow conductance	Flow conductance	Nominal resistance
	DC	b	C-value	
R422102158	2 W	0.25	5.9 l/(s*bar)	280 Ω
R422102162	2 W	0.25	5.9 l/(s*bar)	280 Ω
R422102166	2 W	0.25	5.9 l/(s*bar)	280 Ω
R422102169	2 W	0.25	5.9 l/(s*bar)	280 Ω
R422102172	2 W	0.25	5.9 l/(s*bar)	280 Ω
R422102175	2 W	0.25	5.9 l/(s*bar)	280 Ω

Part No.	Working pressure min./max.
R422102158	3 ... 10 bar
R422102162	3 ... 10 bar
R422102166	3 ... 10 bar
R422102169	-0.9 ... 10 bar
R422102172	-0.9 ... 10 bar
R422102175	-0.9 ... 10 bar

Nominal flow Q_n at 6 bar and Δp = 1 bar, MO = Manual override

Technical information

The min. control pressure must be adhered to, since otherwise faulty switching and valve failure may result!

The pressure dew point must be at least 15 °C under ambient and medium temperature and may not exceed 3 °C .

The oil content of compressed air must remain constant during the life cycle.

Use only the approved oils from AVENTICS. Further information can be found in the "Technical information" document (available in the MediaCentre).

Technical information

Material	
Housing	Polyamide fiber-glass reinforced
Seals	Acrylonitrile butadiene rubber Hydrogenated nitrile butadiene rubber
Front plate	Polyamide fiber-glass reinforced
Threaded bushing	Brass Die cast zinc, nickel-plated chrome-plated

Dimensions

Dimensions

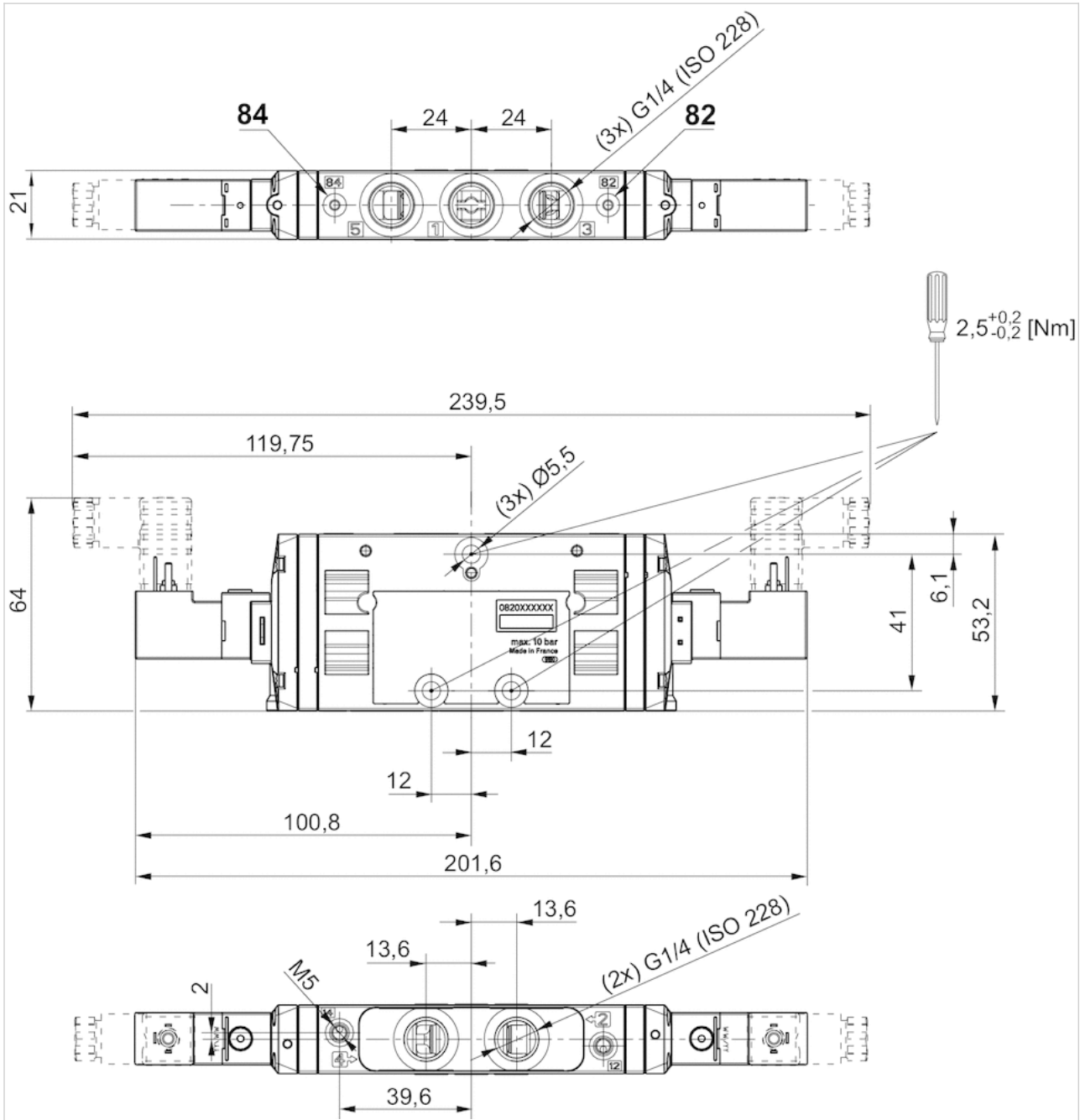













2x3/2-directional valve, Series TC15

- Operating voltage 24 V DC
- 2x3/2
- Qn = 1100 l/min
- Pilot valve width : 15 mm
- NC/NC NO/NO NC/NO
- Pipe connection
- Compressed air connection output : G 1/4
- Electrical connection : Plug, ISO 15217, form C
- Manual override : with detent
- double solenoid
- With spring return
- Pilot : External, Internal



Version	Spool valve, positive overlapping
Activation	Electrically
Pilot	External, Internal
Sealing principle	Soft sealing
Working pressure min./max.	See table below
Control pressure min./max.	3 ... 10 bar
Ambient temperature min./max.	-10 ... 50 °C
Medium temperature min./max.	-10 ... 50 °C
Medium	Compressed air
Max. particle size	5 µm
Oil content of compressed air	0 ... 5 mg/m ³
Nominal flow Qn	1100 l/min
Compressed air connection	according to ISO 228-1
Connector standard	ISO 15217
Protection class with connection	IP65
Duty cycle	100 %
Typ. switch-on time	12 ms
Typ. switch-off time	16 ms
Generic emission standard in accordance with	EN 50081-2:1993
Mounting on manifold strip	P-strip
Mounting screw tightening torque	2.5 Nm
Tightening torque tolerance	±0,2 mT
Weight	0.278 kg

Technical data

Part No.		MO		Compressed air connection	
				Input	
R422102137			NC/NC		G 1/4
R422102141			NO/NO		G 1/4
R422102145			NC/NO		G 1/4
R422102148			NC/NC		G 1/4
R422102151			NO/NO		G 1/4
R422102154			NC/NO		G 1/4

Part No.	Compressed air connection	
	Output	Exhaust
R422102137	G 1/4	G 1/4
R422102141	G 1/4	G 1/4
R422102145	G 1/4	G 1/4
R422102148	G 1/4	G 1/4
R422102151	G 1/4	G 1/4
R422102154	G 1/4	G 1/4

Part No.	Compressed air connection		Operational voltage	Voltage tolerance
	Pilot Input			
R422102137	-		24 V	-10% / +10%
R422102141	-		24 V	-10% / +10%
R422102145	-		24 V	-10% / +10%
R422102148	M5		24 V	-10% / +10%
R422102151	M5		24 V	-10% / +10%
R422102154	M5		24 V	-10% / +10%

Part No.	Power consumption	Flow conductance	Flow conductance	Nominal resistance
	DC	b	C-value	
R422102137	2 W	0.25	5.9 l/(s*bar)	280 Ω
R422102141	2 W	0.25	5.9 l/(s*bar)	280 Ω
R422102145	2 W	0.25	5.9 l/(s*bar)	280 Ω
R422102148	2 W	0.25	5.9 l/(s*bar)	280 Ω
R422102151	2 W	0.25	5.9 l/(s*bar)	280 Ω
R422102154	2 W	0.25	5.9 l/(s*bar)	280 Ω

Part No.	Working pressure min./max.
R422102137	3 ... 10 bar
R422102141	3 ... 10 bar
R422102145	3 ... 10 bar
R422102148	-0.9 ... 10 bar
R422102151	-0.9 ... 10 bar
R422102154	-0.9 ... 10 bar

Nominal flow Q_n at 6 bar and Δp = 1 bar, MO = Manual override

Technical information

The min. control pressure must be adhered to, since otherwise faulty switching and valve failure may result!
 The pressure dew point must be at least 15 °C under ambient and medium temperature and may not exceed 3 °C .
 The oil content of compressed air must remain constant during the life cycle.
 Use only the approved oils from AVENTICS. Further information can be found in the “Technical information” document (available in the MediaCentre).

Technical information

Material	
Housing	Polyamide fiber-glass reinforced
Seals	Acrylonitrile butadiene rubber Hydrogenated nitrile butadiene rubber
Front plate	Polyamide fiber-glass reinforced
Threaded bushing	Brass Die cast zinc, nickel-plated chrome-plated

Dimensions

Dimensions

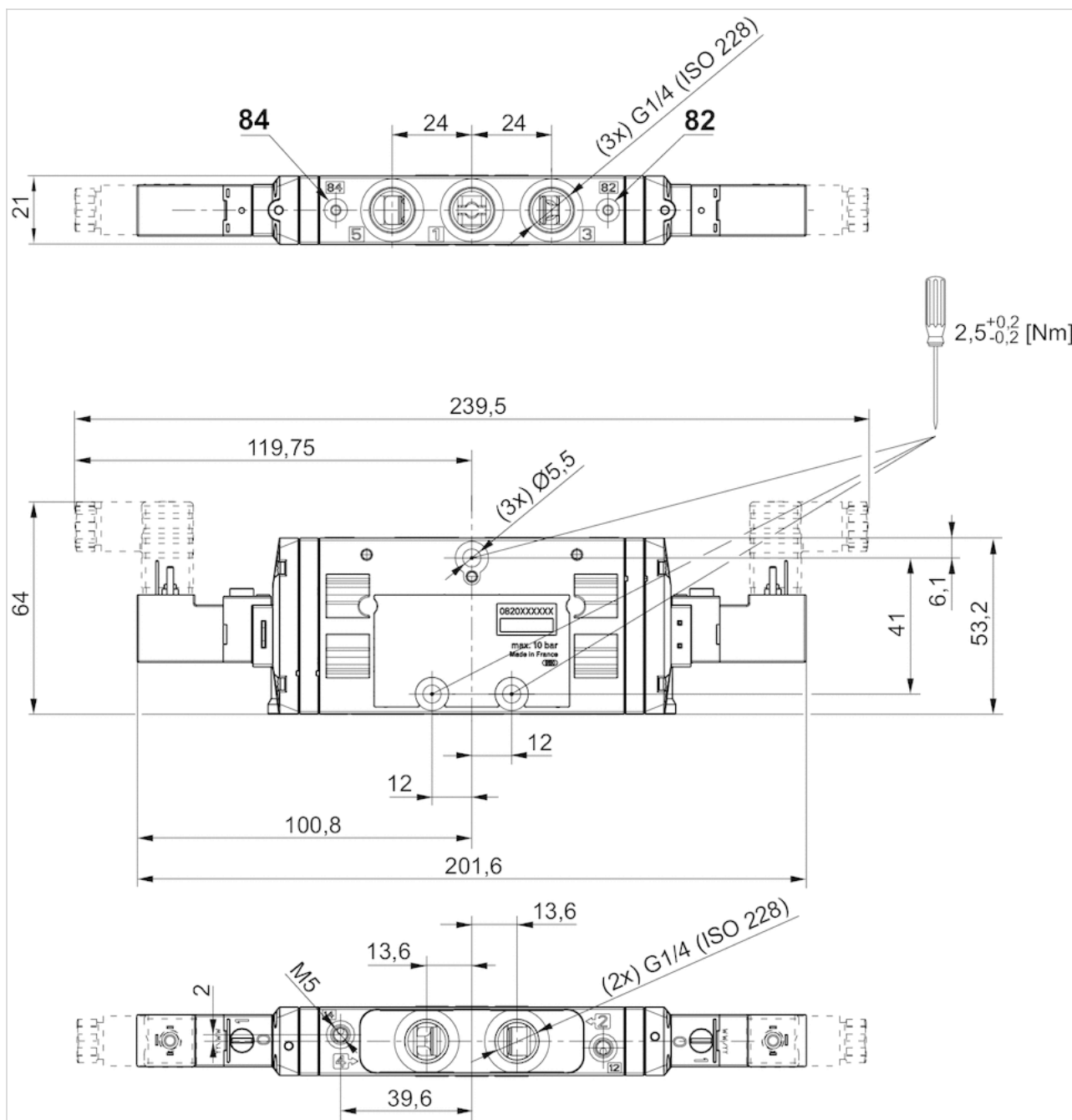































2x3/2-directional valve, Series TC15

- Operating voltage 24 V AC, 110 V AC, 230 V AC
- 2x3/2
- $Q_n = 1100$ l/min
- Pilot valve width : 15 mm
- NC/NC NO/NO NC/NO
- Pipe connection
- Compressed air connection output : G 1/4
- Electrical connection : Plug, ISO 15217, form C
- Manual override : without detent
- double solenoid
- With spring return
- Pilot : External, Internal



Version	Spool valve, positive overlapping
Activation	Electrically
Pilot	External, Internal
Sealing principle	Soft sealing
Working pressure min./max.	See table below
Control pressure min./max.	3 ... 10 bar
Ambient temperature min./max.	-10 ... 50 °C
Medium temperature min./max.	-10 ... 50 °C
Medium	Compressed air
Max. particle size	5 µm
Oil content of compressed air	0 ... 5 mg/m ³
Nominal flow Q_n	1100 l/min
Compressed air connection	according to ISO 228-1
Connector standard	ISO 15217
Protection class with connection	IP65
Duty cycle	100 %
Typ. switch-on time	12 ms
Typ. switch-off time	16 ms
Generic immunity standard in accordance EN 50082-2 with	
Mounting on manifold strip	P-strip
Mounting screw tightening torque	2.5 Nm
Tightening torque tolerance	±0,2 mT
Weight	0.278 kg

Technical data

Part No.		MO	Compressed air connection	
				Input
R422102157			NC/NC	G 1/4
R422102159			NC/NC	G 1/4
R422102160			NC/NC	G 1/4
R422102161			NO/NO	G 1/4
R422102163			NO/NO	G 1/4
R422102164			NO/NO	G 1/4
R422102165			NC/NO	G 1/4
R422102167			NC/NO	G 1/4
R422102168			NC/NO	G 1/4
R422102170			NC/NC	G 1/4
R422102171			NC/NC	G 1/4
R422102173			NO/NO	G 1/4
R422102174			NO/NO	G 1/4
R422102176			NC/NO	G 1/4
R422102177			NC/NO	G 1/4

Part No.	Compressed air connection	
	Output	Exhaust
R422102157	G 1/4	G 1/4
R422102159	G 1/4	G 1/4
R422102160	G 1/4	G 1/4
R422102161	G 1/4	G 1/4
R422102163	G 1/4	G 1/4
R422102164	G 1/4	G 1/4
R422102165	G 1/4	G 1/4
R422102167	G 1/4	G 1/4
R422102168	G 1/4	G 1/4
R422102170	G 1/4	G 1/4
R422102171	G 1/4	G 1/4
R422102173	G 1/4	G 1/4
R422102174	G 1/4	G 1/4
R422102176	G 1/4	G 1/4
R422102177	G 1/4	G 1/4

Part No.	Compressed air connection		Operational voltage	
	Pilot Input		AC 50 Hz	AC 60 Hz
R422102157	-	-	24 V	24 V
R422102159	-	-	110 V	110 V
R422102160	-	-	230 V	230 V
R422102161	-	-	24 V	24 V
R422102163	-	-	110 V	110 V
R422102164	-	-	230 V	230 V
R422102165	-	-	24 V	24 V
R422102167	-	-	110 V	110 V
R422102168	-	-	230 V	230 V

Part No.	Compressed air connection	Operational voltage	Operational voltage
	Pilot Input	AC 50 Hz	AC 60 Hz
R422102170	M5	110 V	110 V
R422102171	M5	230 V	230 V
R422102173	M5	110 V	110 V
R422102174	M5	230 V	230 V
R422102176	M5	110 V	110 V
R422102177	M5	230 V	230 V

Part No.	Voltage tolerance	Voltage tolerance	Holding power	Holding power
	AC 50 Hz	AC 60 Hz	AC 50 Hz	AC 60 Hz
R422102157	-10% / +10%	-10% / +10%	1.6 VA	1.4 VA
R422102159	-10% / +10%	-10% / +10%	1.6 VA	1.4 VA
R422102160	-10% / +10%	-10% / +10%	1.6 VA	1.4 VA
R422102161	-10% / +10%	-10% / +10%	1.6 VA	1.4 VA
R422102163	-10% / +10%	-10% / +10%	1.6 VA	1.4 VA
R422102164	-10% / +10%	-10% / +10%	1.6 VA	1.4 VA
R422102165	-10% / +10%	-10% / +10%	1.6 VA	1.4 VA
R422102167	-10% / +10%	-10% / +10%	1.6 VA	1.4 VA
R422102168	-10% / +10%	-10% / +10%	1.6 VA	1.4 VA
R422102170	-10% / +10%	-10% / +10%	1.6 VA	1.4 VA
R422102171	-10% / +10%	-10% / +10%	1.6 VA	1.4 VA
R422102173	-10% / +10%	-10% / +10%	1.6 VA	1.4 VA
R422102174	-10% / +10%	-10% / +10%	1.6 VA	1.4 VA
R422102176	-10% / +10%	-10% / +10%	1.6 VA	1.4 VA
R422102177	-10% / +10%	-10% / +10%	1.6 VA	1.4 VA

Part No.	Switch-on power	Switch-on power	Flow conductance	Flow conductance
	AC 50 Hz	AC 60 Hz	b	C-value
R422102157	2.2 VA	2 VA	0.25	5.9 l/(s*bar)
R422102159	2.2 VA	2 VA	0.25	5.9 l/(s*bar)
R422102160	2.2 VA	2 VA	0.25	5.9 l/(s*bar)
R422102161	2.2 VA	2 VA	0.25	5.9 l/(s*bar)
R422102163	2.2 VA	2 VA	0.25	5.9 l/(s*bar)
R422102164	2.2 VA	2 VA	0.25	5.9 l/(s*bar)
R422102165	2.2 VA	2 VA	0.25	5.9 l/(s*bar)
R422102167	2.2 VA	2 VA	0.25	5.9 l/(s*bar)
R422102168	2.2 VA	2 VA	0.25	5.9 l/(s*bar)
R422102170	2.2 VA	2 VA	0.25	5.9 l/(s*bar)
R422102171	2.2 VA	2 VA	0.25	5.9 l/(s*bar)
R422102173	2.2 VA	2 VA	0.25	5.9 l/(s*bar)
R422102174	2.2 VA	2 VA	0.25	5.9 l/(s*bar)
R422102176	2.2 VA	2 VA	0.25	5.9 l/(s*bar)
R422102177	2.2 VA	2 VA	0.25	5.9 l/(s*bar)

Part No.	Nominal resistance	Working pressure min./max.
R422102157	185 Ω	3 ... 10 bar
R422102159	3700 Ω	3 ... 10 bar
R422102160	14700 Ω	3 ... 10 bar

Part No.	Nominal resistance	Working pressure min./max.
R422102161	185 Ω	3 ... 10 bar
R422102163	3700 Ω	3 ... 10 bar
R422102164	14700 Ω	3 ... 10 bar
R422102165	185 Ω	3 ... 10 bar
R422102167	3700 Ω	3 ... 10 bar
R422102168	14700 Ω	3 ... 10 bar
R422102170	3700 Ω	-0.9 ... 10 bar
R422102171	14700 Ω	-0.9 ... 10 bar
R422102173	3700 Ω	-0.9 ... 10 bar
R422102174	14700 Ω	-0.9 ... 10 bar
R422102176	3700 Ω	-0.9 ... 10 bar
R422102177	14700 Ω	-0.9 ... 10 bar

Nominal flow Q_n at 6 bar and $\Delta p = 1$ bar, MO = Manual override

Technical information

The min. control pressure must be adhered to, since otherwise faulty switching and valve failure may result!

The pressure dew point must be at least 15 °C under ambient and medium temperature and may not exceed 3 °C .

The oil content of compressed air must remain constant during the life cycle.

Use only the approved oils from AVENTICS. Further information can be found in the "Technical information" document (available in the MediaCentre).

Technical information

Material	
Housing	Polyamide fiber-glass reinforced
Seals	Acrylonitrile butadiene rubber Hydrogenated nitrile butadiene rubber
Front plate	Polyamide fiber-glass reinforced
Threaded bushing	Brass Die cast zinc, nickel-plated chrome-plated

Dimensions

Dimensions

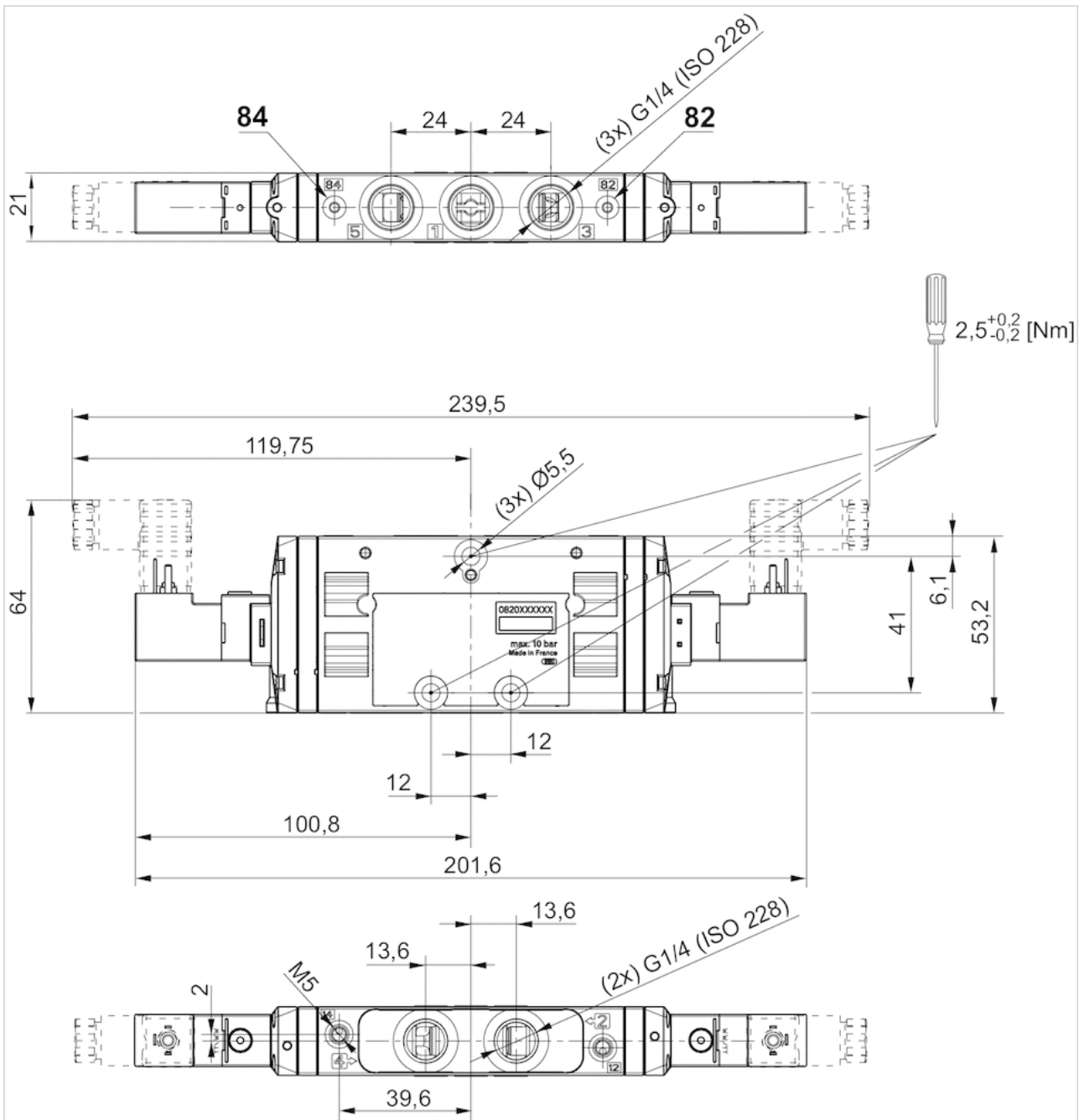

2x3/2-directional valve, Series TC15

- Operating voltage 24 V AC, 110 V AC, 230 V AC
- 2x3/2
- Qn = 1100 l/min
- Pilot valve width : 15 mm
- NC/NC NO/NO NC/NO
- Pipe connection
- Compressed air connection output : G 1/4
- Electrical connection : Plug, ISO 15217, form C
- Manual override : with detent
- double solenoid
- With spring return
- Pilot : Internal



Version	Spool valve, positive overlapping
Activation	Electrically
Pilot	Internal
Sealing principle	Soft sealing
Working pressure min./max.	See table below
Control pressure min./max.	3 ... 10 bar
Ambient temperature min./max.	-10 ... 50 °C
Medium temperature min./max.	-10 ... 50 °C
Medium	Compressed air
Max. particle size	5 µm
Oil content of compressed air	0 ... 5 mg/m ³
Nominal flow Qn	1100 l/min
Compressed air connection	according to ISO 228-1
Connector standard	ISO 15217
Protection class with connection	IP65
Duty cycle	100 %
Typ. switch-on time	12 ms
Typ. switch-off time	16 ms
Generic immunity standard in accordance with	EN 50082-2
Mounting on manifold strip	P-strip
Mounting screw tightening torque	2.5 Nm
Tightening torque tolerance	±0,2 mT
Weight	0.278 kg

Technical data

Part No.		MO		Compressed air connection	
				Input	
R422102136			NC/NC		G 1/4
R422102138			NC/NC		G 1/4
R422102139			NC/NC		G 1/4
R422102140			NO/NO		G 1/4
R422102142			NO/NO		G 1/4
R422102143			NO/NO		G 1/4
R422102144			NC/NO		G 1/4
R422102146			NC/NO		G 1/4
R422102147			NC/NO		G 1/4
R422102149			NC/NC		G 1/4
R422102150			NC/NC		G 1/4
R422102152			NO/NO		G 1/4
R422102153			NO/NO		G 1/4
R422102155			NC/NO		G 1/4
R422102156			NC/NO		G 1/4

Part No.	Compressed air connection	
	Output	Exhaust
R422102136	G 1/4	G 1/4
R422102138	G 1/4	G 1/4
R422102139	G 1/4	G 1/4
R422102140	G 1/4	G 1/4
R422102142	G 1/4	G 1/4
R422102143	G 1/4	G 1/4
R422102144	G 1/4	G 1/4
R422102146	G 1/4	G 1/4
R422102147	G 1/4	G 1/4
R422102149	G 1/4	G 1/4
R422102150	G 1/4	G 1/4
R422102152	G 1/4	G 1/4
R422102153	G 1/4	G 1/4
R422102155	G 1/4	G 1/4
R422102156	G 1/4	G 1/4

Part No.	Compressed air connection		Operational voltage	
	Pilot Input		AC 50 Hz	AC 60 Hz
R422102136	-	-	24 V	24 V
R422102138	-	-	110 V	110 V
R422102139	-	-	230 V	230 V
R422102140	-	-	24 V	24 V
R422102142	-	-	110 V	110 V
R422102143	-	-	230 V	230 V
R422102144	-	-	24 V	24 V
R422102146	-	-	110 V	110 V
R422102147	-	-	230 V	230 V

Part No.	Compressed air connection	Operational voltage	Operational voltage
	Pilot Input	AC 50 Hz	AC 60 Hz
R422102149	M5	110 V	110 V
R422102150	M5	230 V	230 V
R422102152	M5	110 V	110 V
R422102153	M5	230 V	230 V
R422102155	M5	110 V	110 V
R422102156	M5	230 V	230 V

Part No.	Voltage tolerance	Voltage tolerance	Holding power	Holding power
	AC 50 Hz	AC 60 Hz	AC 50 Hz	AC 60 Hz
R422102136	-10% / +10%	-10% / +10%	1.6 VA	1.4 VA
R422102138	-10% / +10%	-10% / +10%	1.6 VA	1.4 VA
R422102139	-10% / +10%	-10% / +10%	1.6 VA	1.4 VA
R422102140	-10% / +10%	-10% / +10%	1.6 VA	1.4 VA
R422102142	-10% / +10%	-10% / +10%	1.6 VA	1.4 VA
R422102143	-10% / +10%	-10% / +10%	1.6 VA	1.4 VA
R422102144	-10% / +10%	-10% / +10%	1.6 VA	1.4 VA
R422102146	-10% / +10%	-10% / +10%	1.6 VA	1.4 VA
R422102147	-10% / +10%	-10% / +10%	1.6 VA	1.4 VA
R422102149	-10% / +10%	-10% / +10%	1.6 VA	1.4 VA
R422102150	-10% / +10%	-10% / +10%	1.6 VA	1.4 VA
R422102152	-10% / +10%	-10% / +10%	1.6 VA	1.4 VA
R422102153	-10% / +10%	-10% / +10%	1.6 VA	1.4 VA
R422102155	-10% / +10%	-10% / +10%	1.6 VA	1.4 VA
R422102156	-10% / +10%	-10% / +10%	1.6 VA	1.4 VA

Part No.	Switch-on power	Switch-on power	Flow conductance	Flow conductance
	AC 50 Hz	AC 60 Hz	b	C-value
R422102136	2.2 VA	2 VA	0.25	5.9 l/(s*bar)
R422102138	2.2 VA	2 VA	0.25	5.9 l/(s*bar)
R422102139	2.2 VA	2 VA	0.25	5.9 l/(s*bar)
R422102140	2.2 VA	2 VA	0.25	5.9 l/(s*bar)
R422102142	2.2 VA	2 VA	0.25	5.9 l/(s*bar)
R422102143	2.2 VA	2 VA	0.25	5.9 l/(s*bar)
R422102144	2.2 VA	2 VA	0.25	5.9 l/(s*bar)
R422102146	2.2 VA	2 VA	0.25	5.9 l/(s*bar)
R422102147	2.2 VA	2 VA	0.25	5.9 l/(s*bar)
R422102149	2.2 VA	2 VA	0.25	5.9 l/(s*bar)
R422102150	2.2 VA	2 VA	0.25	5.9 l/(s*bar)
R422102152	2.2 VA	2 VA	0.25	5.9 l/(s*bar)
R422102153	2.2 VA	2 VA	0.25	5.9 l/(s*bar)
R422102155	2.2 VA	2 VA	0.25	5.9 l/(s*bar)
R422102156	2.2 VA	2 VA	0.25	5.9 l/(s*bar)

Part No.	Nominal resistance	Working pressure min./max.
R422102136	185 Ω	3 ... 10 bar
R422102138	3700 Ω	3 ... 10 bar
R422102139	14700 Ω	3 ... 10 bar

Part No.	Nominal resistance	Working pressure min./max.
R422102140	185 Ω	3 ... 10 bar
R422102142	3700 Ω	3 ... 10 bar
R422102143	14700 Ω	3 ... 10 bar
R422102144	185 Ω	3 ... 10 bar
R422102146	3700 Ω	3 ... 10 bar
R422102147	14700 Ω	3 ... 10 bar
R422102149	3700 Ω	-0.9 ... 10 bar
R422102150	14700 Ω	-0.9 ... 10 bar
R422102152	3700 Ω	-0.9 ... 10 bar
R422102153	14700 Ω	-0.9 ... 10 bar
R422102155	3700 Ω	-0.9 ... 10 bar
R422102156	14700 Ω	-0.9 ... 10 bar

Part No.	push-in fitting
R422102136	Brass Die cast zinc chrome-plated nickel-plated
R422102138	Brass Die cast zinc chrome-plated nickel-plated
R422102139	Brass Die cast zinc chrome-plated nickel-plated
R422102140	Brass Die cast zinc chrome-plated nickel-plated
R422102142	Brass Die cast zinc chrome-plated nickel-plated
R422102143	Brass Die cast zinc chrome-plated nickel-plated
R422102144	Brass Die cast zinc chrome-plated nickel-plated
R422102146	Brass Die cast zinc chrome-plated nickel-plated
R422102147	Brass Die cast zinc chrome-plated nickel-plated
R422102149	Brass Die cast zinc chrome-plated nickel-plated
R422102150	Brass Die cast zinc chrome-plated nickel-plated
R422102152	Brass Die cast zinc chrome-plated nickel-plated
R422102153	Brass Die cast zinc chrome-plated nickel-plated
R422102155	Brass Die cast zinc chrome-plated nickel-plated
R422102156	-

Part No.	Valve plug connector
R422102136	Without valve plug connector
R422102138	Without valve plug connector
R422102139	Without valve plug connector
R422102140	Without valve plug connector
R422102142	Without valve plug connector
R422102143	Without valve plug connector
R422102144	Without valve plug connector
R422102146	Without valve plug connector
R422102147	Without valve plug connector
R422102149	Without valve plug connector
R422102150	Without valve plug connector
R422102152	Without valve plug connector
R422102153	Without valve plug connector
R422102155	Without valve plug connector
R422102156	Without valve plug connector

Part No.	basic valve with electrical connector
R422102136	Basic valve with coil without valve plug connector
R422102138	Basic valve with coil without valve plug connector
R422102139	Basic valve with coil without valve plug connector
R422102140	Basic valve with coil without valve plug connector
R422102142	Basic valve with coil without valve plug connector
R422102143	Basic valve with coil without valve plug connector
R422102144	Basic valve with coil without valve plug connector
R422102146	Basic valve with coil without valve plug connector
R422102147	Basic valve with coil without valve plug connector
R422102149	Basic valve with coil without valve plug connector
R422102150	Basic valve with coil without valve plug connector
R422102152	Basic valve with coil without valve plug connector
R422102153	Basic valve with coil without valve plug connector
R422102155	Basic valve with coil without valve plug connector
R422102156	Basic valve with coil without valve plug connector

Nominal flow Q_n at 6 bar and $\Delta p = 1$ bar, MO = Manual override

Technical information

The min. control pressure must be adhered to, since otherwise faulty switching and valve failure may result!

The pressure dew point must be at least 15 °C under ambient and medium temperature and may not exceed 3 °C .

The oil content of compressed air must remain constant during the life cycle.

Use only the approved oils from AVENTICS. Further information can be found in the "Technical information" document (available in the MediaCentre).

Technical information

Material	
Housing	Polyamide fiber-glass reinforced
Seals	Acrylonitrile butadiene rubber Hydrogenated nitrile butadiene rubber
Front plate	Polyamide fiber-glass reinforced
Threaded bushing	Brass Die cast zinc, chrome-plated nickel-plated





















5/2-directional valve, Series TC15

- Operating voltage 24 V DC
- 5/2
- $Q_n = 1500$ l/min
- Pilot valve width : 15 mm
- Pipe connection
- Compressed air connection output : G 1/4
- Electrical connection : Plug, ISO 15217, form C
- Manual override : without detent
- single solenoid double solenoid
- Pilot : Internal External



Version	Spool valve, positive overlapping
Activation	Electrically
Sealing principle	Soft sealing
Working pressure min./max.	See table below
Control pressure min./max.	See table below
Ambient temperature min./max.	-10 ... 50 °C
Medium temperature min./max.	-10 ... 50 °C
Medium	Compressed air
Max. particle size	5 μm
Oil content of compressed air	0 ... 5 mg/m ³
Nominal flow Q_n	1500 l/min
Connector standard	ISO 15217
Protection class with connection	IP65
Duty cycle	100 %
Mounting on manifold strip	P-strip
Mounting screw tightening torque	2.5 Nm
Weight	See table below
Comment	An example configuration is illustrated. The delivered product may thus deviate from the illustration.

Technical data

Part No.		MO	Compressed air connection	
			Input	Output
0820058101			G 1/4	G 1/4
0820058151			G 1/4	G 1/4
0820058126			G 1/4	G 1/4
R422103064			G 1/4	G 1/4
0820058176			G 1/4	G 1/4
R422103066			G 1/4	G 1/4
0820058601			G 1/4	G 1/4
R422103068			G 1/4	G 1/4
0820058651			G 1/4	G 1/4
R422103070			G 1/4	G 1/4

Part No.	Compressed air connection	
	Exhaust	Pilot Input
0820058101	G 1/4	-
0820058151	G 1/4	M5
0820058126	G 1/4	-
R422103064	G 1/4	-
0820058176	G 1/4	M5
R422103066	G 1/4	M5
0820058601	G 1/4	-
R422103068	G 1/4	-
0820058651	G 1/4	M5
R422103070	G 1/4	M5

Part No.	Operational voltage	Voltage tolerance	Power consumption	Pilot
0820058101	24 V	-10% / +10%	2 W	Internal
0820058151	24 V	-10% / +10%	2 W	External
0820058126	24 V	-10% / +10%	2 W	Internal
R422103064	-	-	-	Internal
0820058176	24 V	-10% / +10%	2 W	External
R422103066	-	-	-	External
0820058601	24 V	-10% / +10%	2 W	Internal
R422103068	-	-	-	Internal
0820058651	24 V	-10% / +10%	2 W	External
R422103070	-	-	-	External

Part No.	Flow conductance	Flow conductance	Nominal resistance	Working pressure min./max.
	b	C-value		
0820058101	0.33	6.8 l/(s*bar)	280 Ω	2.5 ... 10 bar
0820058151	0.33	6.8 l/(s*bar)	280 Ω	-0.9 ... 10 bar
0820058126	0.33	6.8 l/(s*bar)	280 Ω	3 ... 10 bar
R422103064	0.33	6.8 l/(s*bar)	-	3 ... 10 bar
0820058176	0.33	6.8 l/(s*bar)	280 Ω	-0.9 ... 10 bar
R422103066	0.33	6.8 l/(s*bar)	-	-0.9 ... 10 bar
0820058601	0.33	6.8 l/(s*bar)	280 Ω	2 ... 10 bar

Part No.	Flow conductance	Flow conductance	Nominal resistance	Working pressure min./max.
	b	C-value		
R422103068	0.33	6.8 l/(s*bar)	-	2 ... 10 bar
0820058651	0.33	6.8 l/(s*bar)	280 Ω	-0.9 ... 10 bar
R422103070	0.33	6.8 l/(s*bar)	-	-0.9 ... 10 bar

Part No.	Control pressure min./max.	Typ. switch-on time	Typ. switch-off time
0820058101	2.5 ... 10 bar	21 ms	22 ms
0820058151	2.5 ... 10 bar	21 ms	22 ms
0820058126	3 ... 10 bar	12 ms	35 ms
R422103064	3 ... 10 bar	12 ms	35 ms
0820058176	3 ... 10 bar	12 ms	35 ms
R422103066	3 ... 10 bar	12 ms	35 ms
0820058601	2 ... 10 bar	10 ms	10 ms
R422103068	2 ... 10 bar	10 ms	10 ms
0820058651	2 ... 10 bar	10 ms	10 ms
R422103070	2 ... 10 bar	10 ms	10 ms

Part No.	basic valve with electrical connector	Weight
0820058101	-	0.235 kg
0820058151	-	0.235 kg
0820058126	-	0.235 kg
R422103064	Basic valve without coil	0.235 kg
0820058176	-	0.235 kg
R422103066	Basic valve without coil	0.235 kg
0820058601	-	0.263 kg
R422103068	Basic valve without coil	0.263 kg
0820058651	-	0.263 kg
R422103070	Basic valve without coil	0.263 kg

Nominal flow Qn at 6 bar and $\Delta p = 1$ bar, MO = Manual override

Technical information

The min. control pressure must be adhered to, since otherwise faulty switching and valve failure may result!

The pressure dew point must be at least 15 °C under ambient and medium temperature and may not exceed 3 °C .

The oil content of compressed air must remain constant during the life cycle.

Use only the approved oils from AVENTICS. Further information can be found in the "Technical information" document (available in the MediaCentre).

Technical information

Material	
Housing	Polyamide fiber-glass reinforced
Seals	Acrylonitrile butadiene rubber Hydrogenated nitrile butadiene rubber
Front plate	Polyamide fiber-glass reinforced
Threaded bushing	Brass Die cast zinc, nickel-plated chrome-plated

Dimensions

dimensions, single solenoid

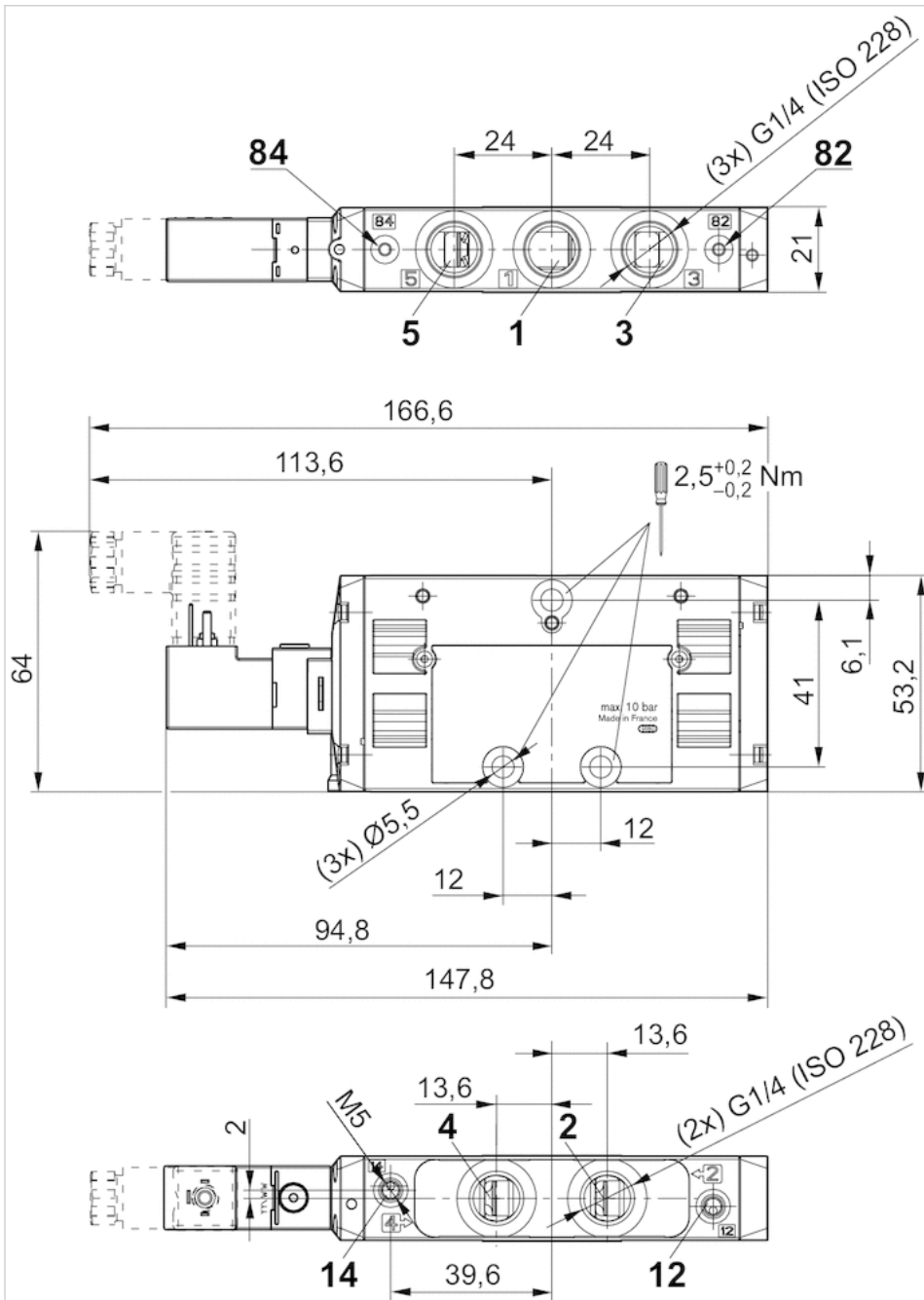

dimensions, double solenoid

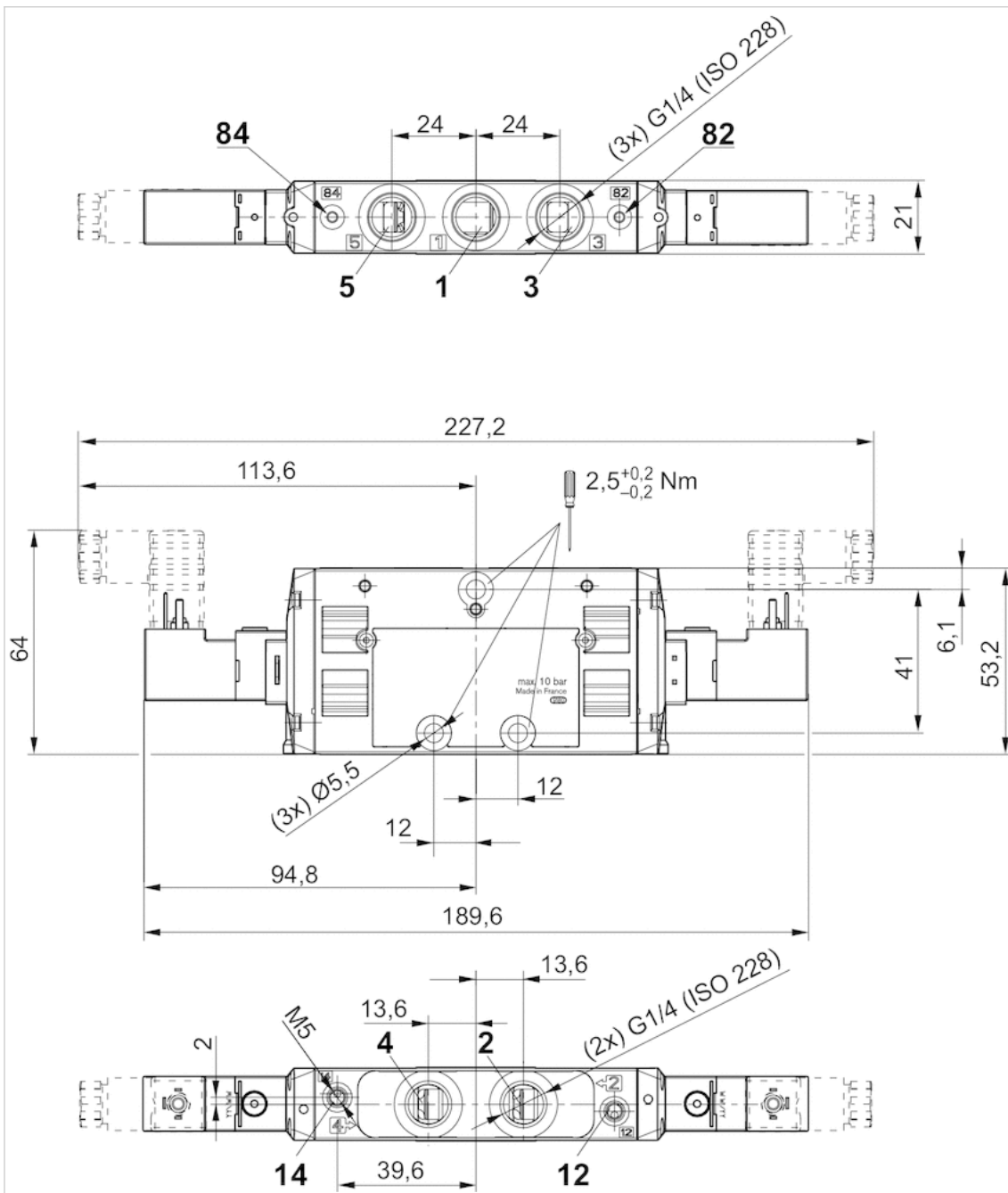





















5/2-directional valve, Series TC15

- Operating voltage 24 V DC
- 5/2
- $Q_n = 1500$ l/min
- Pilot valve width : 15 mm
- Pipe connection
- Compressed air connection output : G 1/4
- Electrical connection : Plug, ISO 15217, form C
- Manual override : with detent
- single solenoid double solenoid
- Pilot : Internal External



Version	Spool valve, positive overlapping
Activation	Electrically
Sealing principle	Soft sealing
Working pressure min./max.	See table below
Control pressure min./max.	See table below
Ambient temperature min./max.	-10 ... 50 °C
Medium temperature min./max.	-10 ... 50 °C
Medium	Compressed air
Max. particle size	5 µm
Oil content of compressed air	0 ... 5 mg/m ³
Nominal flow Q_n	1500 l/min
Connector standard	ISO 15217
Protection class with connection	IP65
Duty cycle	100 %
Mounting on manifold strip	P-strip
Mounting screw tightening torque	2.5 Nm
Weight	See table below
Comment	An example configuration is illustrated. The delivered product may thus deviate from the illustration.

Technical data

Part No.		MO	Compressed air connection	
			Input	Output
0820058001			G 1/4	G 1/4
0820058051			G 1/4	G 1/4
0820058026			G 1/4	G 1/4
R422103063			G 1/4	G 1/4
0820058076			G 1/4	G 1/4
R422103065			G 1/4	G 1/4
0820058501			G 1/4	G 1/4
R422103067			G 1/4	G 1/4
0820058551			G 1/4	G 1/4
R422103069			G 1/4	G 1/4

Part No.	Compressed air connection	
	Exhaust	Pilot Input
0820058001	G 1/4	-
0820058051	G 1/4	M5
0820058026	G 1/4	-
R422103063	G 1/4	-
0820058076	G 1/4	M5
R422103065	G 1/4	M5
0820058501	G 1/4	-
R422103067	G 1/4	-
0820058551	G 1/4	M5
R422103069	G 1/4	M5

Part No.	Operational voltage	Voltage tolerance	Power consumption		Pilot
			DC	DC	
0820058001	24 V	-10% / +10%	2 W		Internal
0820058051	24 V	-10% / +10%	2 W		External
0820058026	24 V	-10% / +10%	2 W		Internal
R422103063	-	-	-		Internal
0820058076	24 V	-10% / +10%	2 W		External
R422103065	-	-	-		External
0820058501	24 V	-10% / +10%	2 W		Internal
R422103067	-	-	-		Internal
0820058551	24 V	-10% / +10%	2 W		External
R422103069	-	-	-		External

Part No.	Flow conductance	Flow conductance	Nominal resistance	Working pressure min./max.
	b	C-value		
0820058001	0.33	6.8 l/(s*bar)	280 Ω	2.5 ... 10 bar
0820058051	0.33	6.8 l/(s*bar)	280 Ω	-0.9 ... 10 bar
0820058026	0.33	6.8 l/(s*bar)	280 Ω	3 ... 10 bar
R422103063	0.33	6.8 l/(s*bar)	-	3 ... 10 bar
0820058076	0.33	6.8 l/(s*bar)	280 Ω	-0.9 ... 10 bar
R422103065	0.33	6.8 l/(s*bar)	-	-0.9 ... 10 bar
0820058501	0.33	6.8 l/(s*bar)	280 Ω	2 ... 10 bar

Part No.	Flow conductance	Flow conductance	Nominal resistance	Working pressure min./max.
	b	C-value		
R422103067	0.33	6.8 l/(s*bar)	-	2 ... 10 bar
0820058551	0.33	6.8 l/(s*bar)	280 Ω	-0.9 ... 10 bar
R422103069	0.33	6.8 l/(s*bar)	-	-0.9 ... 10 bar

Part No.	Control pressure min./max.	Typ. switch-on time	Typ. switch-off time
0820058001	2.5 ... 10 bar	21 ms	22 ms
0820058051	2.5 ... 10 bar	21 ms	22 ms
0820058026	3 ... 10 bar	12 ms	35 ms
R422103063	3 ... 10 bar	12 ms	35 ms
0820058076	3 ... 10 bar	12 ms	35 ms
R422103065	3 ... 10 bar	12 ms	35 ms
0820058501	2 ... 10 bar	10 ms	10 ms
R422103067	2 ... 10 bar	10 ms	10 ms
0820058551	2 ... 10 bar	10 ms	10 ms
R422103069	2 ... 10 bar	10 ms	10 ms

Part No.	basic valve with electrical connector	Weight
0820058001	-	0.235 kg
0820058051	-	0.235 kg
0820058026	-	0.235 kg
R422103063	Basic valve without coil	0.235 kg
0820058076	-	0.235 kg
R422103065	Basic valve without coil	0.235 kg
0820058501	-	0.263 kg
R422103067	Basic valve without coil	0.263 kg
0820058551	-	0.263 kg
R422103069	Basic valve without coil	0.263 kg

Nominal flow Qn at 6 bar and $\Delta p = 1$ bar, MO = Manual override

Technical information

The min. control pressure must be adhered to, since otherwise faulty switching and valve failure may result!

The pressure dew point must be at least 15 °C under ambient and medium temperature and may not exceed 3 °C .

The oil content of compressed air must remain constant during the life cycle.

Use only the approved oils from AVENTICS. Further information can be found in the "Technical information" document (available in the MediaCentre).

Technical information

Material	
Housing	Polyamide fiber-glass reinforced
Seals	Acrylonitrile butadiene rubber Hydrogenated nitrile butadiene rubber
Front plate	Polyamide fiber-glass reinforced
Threaded bushing	Brass Die cast zinc, nickel-plated chrome-plated

Dimensions

Dimensions, single solenoid

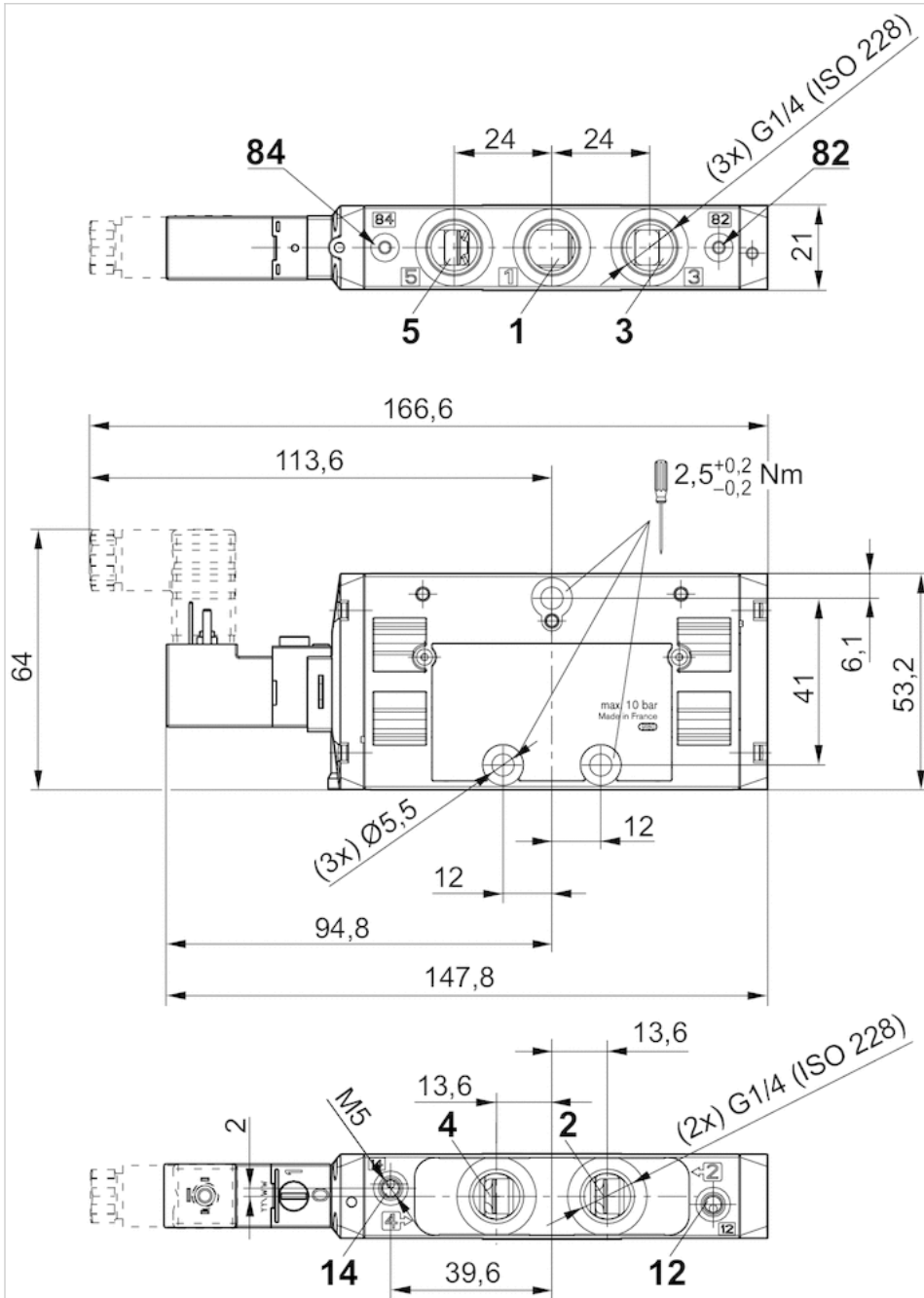

Dimensions, double solenoid

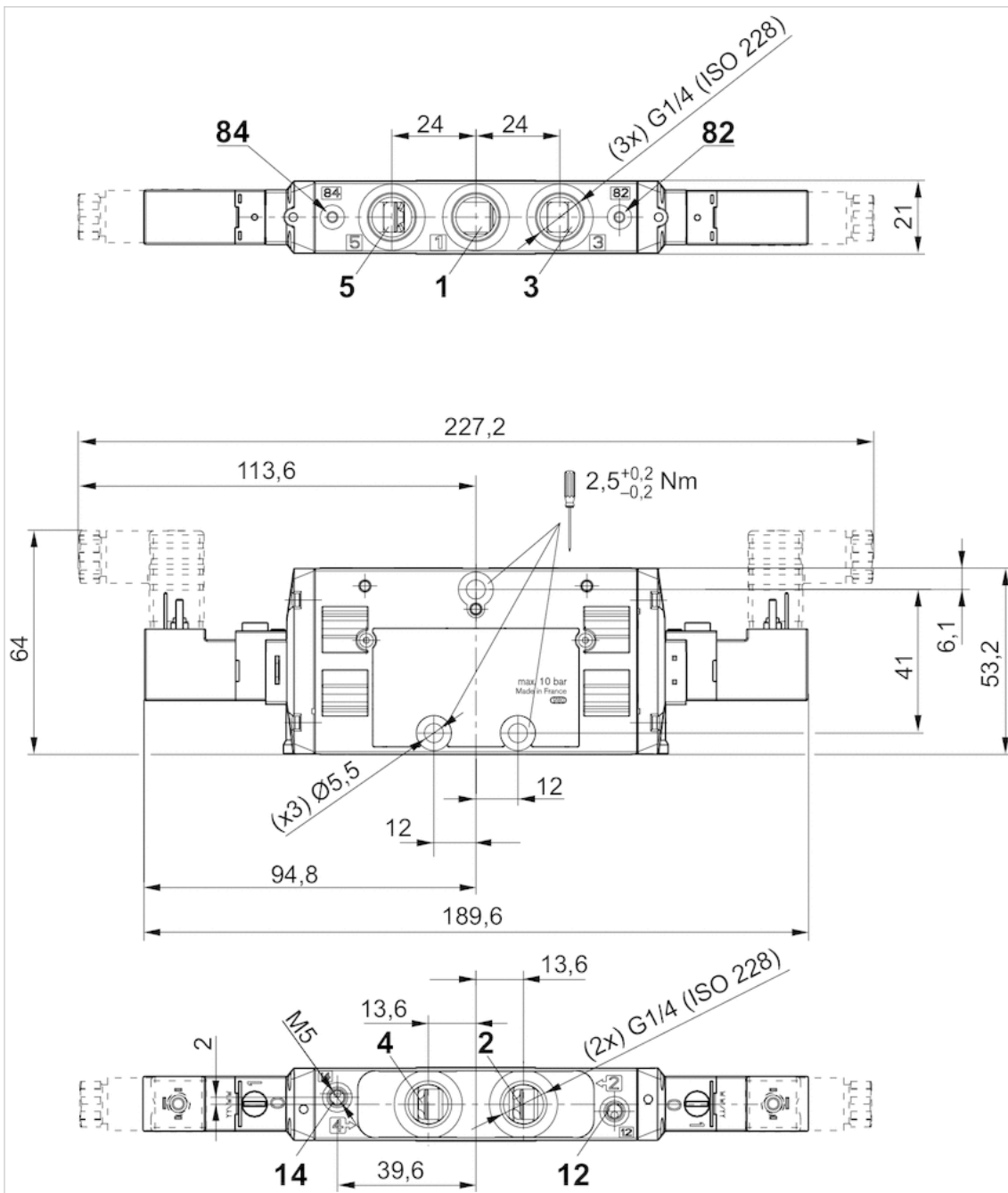

5/2-directional valve, Series TC15

- Operating voltage 24 V AC, 110 V AC, 230 V AC
- 5/2
- $Q_n = 1500$ l/min
- Pilot valve width : 15 mm
- Pipe connection
- Compressed air connection output : G 1/4
- Electrical connection : Plug, ISO 15217, form C
- Manual override : without detent
- single solenoid double solenoid
- Pilot : Internal External



Version	Spool valve, positive overlapping
Activation	Electrically
Sealing principle	Soft sealing
Working pressure min./max.	See table below
Control pressure min./max.	See table below
Ambient temperature min./max.	-10 ... 50 °C
Medium temperature min./max.	-10 ... 50 °C
Medium	Compressed air
Max. particle size	5 µm
Oil content of compressed air	0 ... 5 mg/m ³
Nominal flow Q_n	1500 l/min
Connector standard	ISO 15217
Protection class with connection	IP65
Duty cycle	100 %
Generic emission standard in accordance with	EN 50081:1992
Mounting on manifold strip	P-strip
Mounting screw tightening torque	2.5 Nm
Weight	See table below
Comment	An example configuration is illustrated. The delivered product may thus deviate from the illustration.

Technical data

Part No.		MO	Compressed air connection	
			Input	Output
R422000117			G 1/4	G 1/4
0820058102			G 1/4	G 1/4
0820058103			G 1/4	G 1/4
0820058152			G 1/4	G 1/4
0820058153			G 1/4	G 1/4
R422000119			G 1/4	G 1/4
0820058127			G 1/4	G 1/4
0820058128			G 1/4	G 1/4
0820058177			G 1/4	G 1/4
0820058178			G 1/4	G 1/4
R422000121			G 1/4	G 1/4
0820058602			G 1/4	G 1/4
0820058603			G 1/4	G 1/4
0820058652			G 1/4	G 1/4
0820058653			G 1/4	G 1/4

Part No.	Compressed air connection	
	Exhaust	Pilot Input
R422000117	G 1/4	-
0820058102	G 1/4	-
0820058103	G 1/4	-
0820058152	G 1/4	M5
0820058153	G 1/4	M5
R422000119	G 1/4	-
0820058127	G 1/4	-
0820058128	G 1/4	-
0820058177	G 1/4	M5
0820058178	G 1/4	M5
R422000121	G 1/4	-
0820058602	G 1/4	-
0820058603	G 1/4	-
0820058652	G 1/4	M5
0820058653	G 1/4	M5

Part No.	Operational voltage		Voltage tolerance
	AC 50 Hz	AC 60 Hz	AC 50 Hz
R422000117	24 V	24 V	-10% / +10%
0820058102	110 V	110 V	-10% / +10%
0820058103	230 V	230 V	-10% / +10%
0820058152	110 V	110 V	-10% / +10%
0820058153	230 V	230 V	-10% / +10%
R422000119	24 V	24 V	-10% / +10%
0820058127	110 V	110 V	-10% / +10%
0820058128	230 V	230 V	-10% / +10%
0820058177	110 V	110 V	-10% / +10%

Part No.	Operational voltage	Operational voltage	Voltage tolerance
	AC 50 Hz	AC 60 Hz	AC 50 Hz
0820058178	230 V	230 V	-10% / +10%
R422000121	24 V	24 V	-10% / +10%
0820058602	110 V	110 V	-10% / +10%
0820058603	230 V	230 V	-10% / +10%
0820058652	110 V	110 V	-10% / +10%
0820058653	230 V	230 V	-10% / +10%

Part No.	Voltage tolerance	Holding power	Holding power	Switch-on power
	AC 60 Hz	AC 50 Hz	AC 60 Hz	AC 50 Hz
R422000117	-10% / +10%	1.6 VA	1.4 VA	2.2 VA
0820058102	-10% / +10%	1.6 VA	1.4 VA	2.2 VA
0820058103	-10% / +10%	1.6 VA	1.4 VA	2.2 VA
0820058152	-10% / +10%	1.6 VA	1.4 VA	2.2 VA
0820058153	-10% / +10%	1.6 VA	1.4 VA	2.2 VA
R422000119	-10% / +10%	1.6 VA	1.4 VA	2.2 VA
0820058127	-10% / +10%	1.6 VA	1.4 VA	2.2 VA
0820058128	-10% / +10%	1.6 VA	1.4 VA	2.2 VA
0820058177	-10% / +10%	1.6 VA	1.4 VA	2.2 VA
0820058178	-10% / +10%	1.6 VA	1.4 VA	2.2 VA
R422000121	-10% / +10%	1.6 VA	1.4 VA	2.2 VA
0820058602	-10% / +10%	1.6 VA	1.4 VA	2.2 VA
0820058603	-10% / +10%	1.6 VA	1.4 VA	2.2 VA
0820058652	-10% / +10%	1.6 VA	1.4 VA	2.2 VA
0820058653	-10% / +10%	1.6 VA	1.4 VA	2.2 VA

Part No.	Switch-on power	Pilot	Flow conductance	Flow conductance	Nominal resistance
	AC 60 Hz		b	C-value	
R422000117	2 VA	Internal	0.33	6.8 l/(s*bar)	185 Ω
0820058102	2 VA	Internal	0.33	6.8 l/(s*bar)	3700 Ω
0820058103	2 VA	Internal	0.33	6.8 l/(s*bar)	14700 Ω
0820058152	2 VA	External	0.33	6.8 l/(s*bar)	3700 Ω
0820058153	2 VA	External	0.33	6.8 l/(s*bar)	14700 Ω
R422000119	2 VA	Internal	0.33	6.8 l/(s*bar)	185 Ω
0820058127	2 VA	Internal	0.33	6.8 l/(s*bar)	3700 Ω
0820058128	2 VA	Internal	0.33	6.8 l/(s*bar)	14700 Ω
0820058177	2 VA	External	0.33	6.8 l/(s*bar)	3700 Ω
0820058178	2 VA	External	0.33	6.8 l/(s*bar)	14700 Ω
R422000121	2 VA	Internal	0.33	6.8 l/(s*bar)	185 Ω
0820058602	2 VA	Internal	0.33	6.8 l/(s*bar)	3700 Ω
0820058603	2 VA	Internal	0.33	6.8 l/(s*bar)	14700 Ω
0820058652	2 VA	External	0.33	6.8 l/(s*bar)	3700 Ω
0820058653	2 VA	External	0.33	6.8 l/(s*bar)	14700 Ω

Part No.	Working pressure min./max.	Control pressure min./max.	Typ. switch-on time	Typ. switch-off time
R422000117	2.5 ... 10 bar	2.5 ... 10 bar	21 ms	22 ms
0820058102	2.5 ... 10 bar	2.5 ... 10 bar	21 ms	22 ms
0820058103	2.5 ... 10 bar	2.5 ... 10 bar	21 ms	22 ms

Part No.	Working pressure min./max.	Control pressure min./max.	Typ. switch-on time	Typ. switch-off time
0820058152	-0.9 ... 10 bar	2.5 ... 10 bar	21 ms	22 ms
0820058153	-0.9 ... 10 bar	2.5 ... 10 bar	21 ms	22 ms
R422000119	3 ... 10 bar	3 ... 10 bar	12 ms	35 ms
0820058127	3 ... 10 bar	3 ... 10 bar	12 ms	35 ms
0820058128	3 ... 10 bar	3 ... 10 bar	12 ms	35 ms
0820058177	-0.9 ... 10 bar	3 ... 10 bar	12 ms	35 ms
0820058178	-0.9 ... 10 bar	3 ... 10 bar	12 ms	35 ms
R422000121	2 ... 10 bar	2 ... 10 bar	10 ms	10 ms
0820058602	2 ... 10 bar	2 ... 10 bar	10 ms	10 ms
0820058603	2 ... 10 bar	2 ... 10 bar	10 ms	10 ms
0820058652	-0.9 ... 10 bar	2 ... 10 bar	10 ms	10 ms
0820058653	-0.9 ... 10 bar	2 ... 10 bar	10 ms	10 ms

Part No.	Weight
R422000117	0.235 kg
0820058102	0.235 kg
0820058103	0.235 kg
0820058152	0.235 kg
0820058153	0.235 kg
R422000119	0.235 kg
0820058127	0.235 kg
0820058128	0.235 kg
0820058177	0.235 kg
0820058178	0.235 kg
R422000121	0.263 kg
0820058602	0.263 kg
0820058603	0.263 kg
0820058652	0.263 kg
0820058653	0.263 kg

Nominal flow Q_n at 6 bar and $\Delta p = 1$ bar, MO = Manual override

Technical information

The min. control pressure must be adhered to, since otherwise faulty switching and valve failure may result!

The pressure dew point must be at least 15 °C under ambient and medium temperature and may not exceed 3 °C .

The oil content of compressed air must remain constant during the life cycle.

Use only the approved oils from AVENTICS. Further information can be found in the "Technical information" document (available in the MediaCentre).

Technical information

Material	
Housing	Polyamide fiber-glass reinforced
Seals	Acrylonitrile butadiene rubber Hydrogenated nitrile butadiene rubber
Front plate	Polyamide fiber-glass reinforced

Material	
Threaded bushing	Brass Die cast zinc, nickel-plated chrome-plated

Dimensions

dimensions, single solenoid

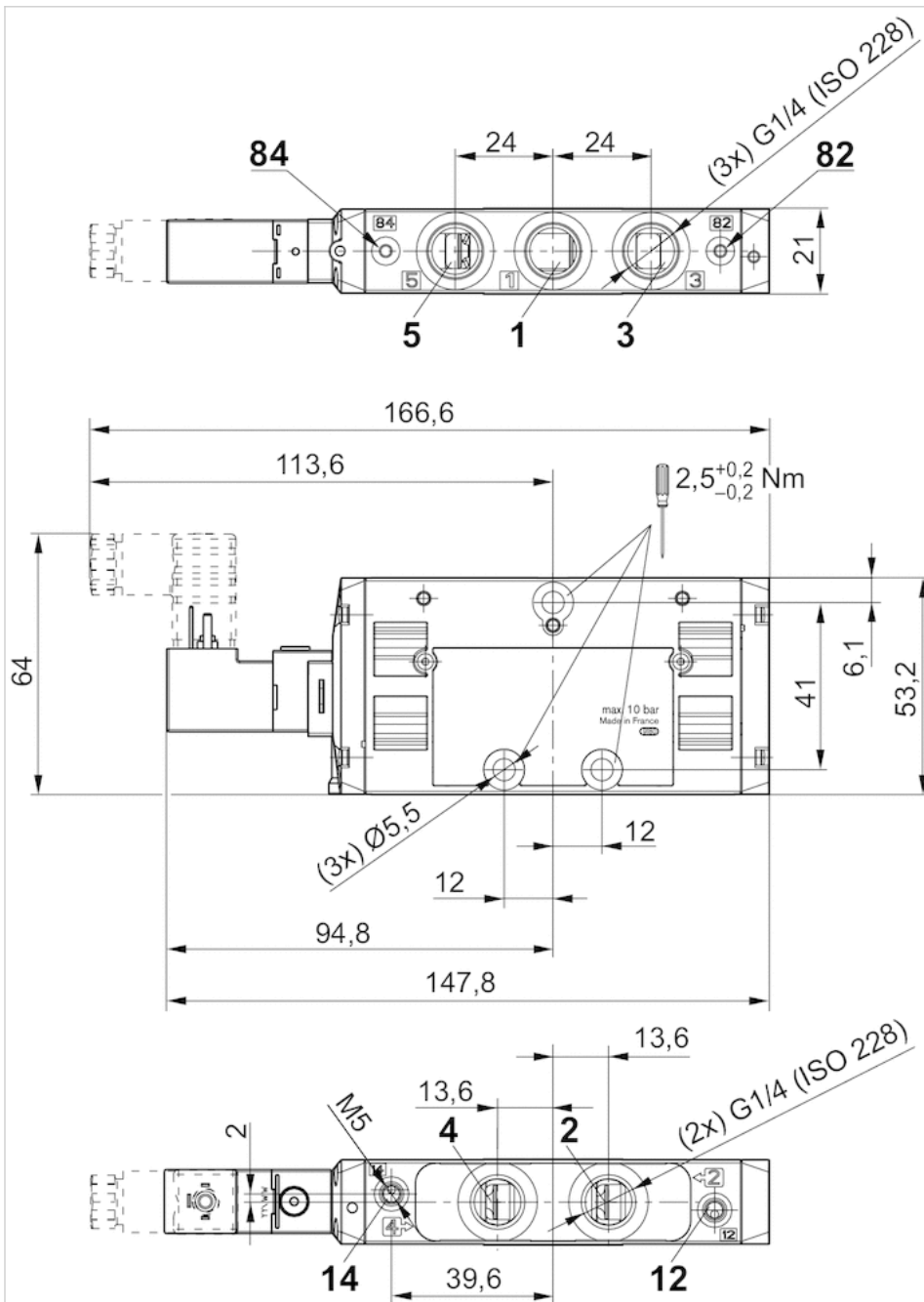

dimensions, double solenoid

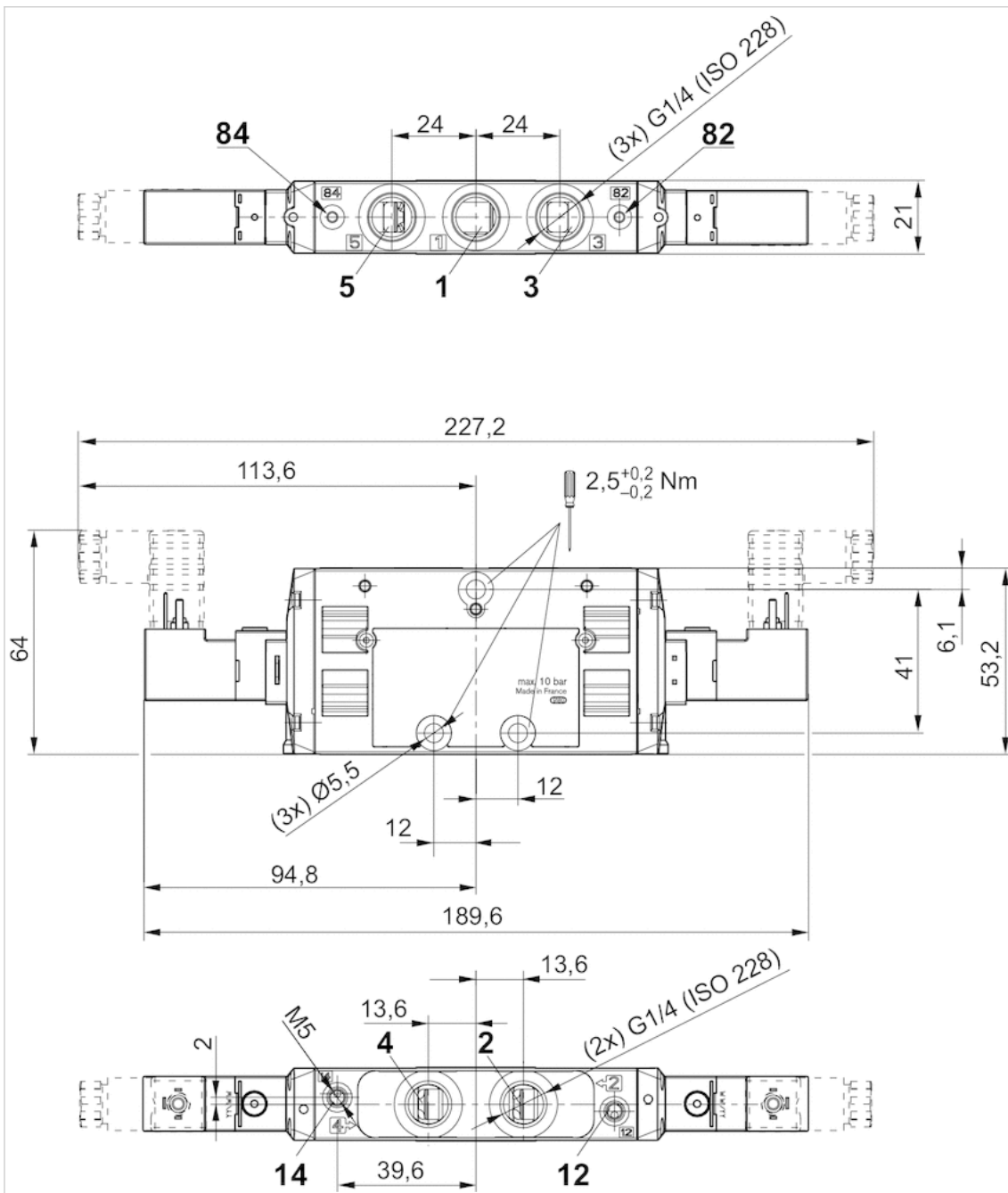































5/2-directional valve, Series TC15

- Operating voltage 24 V AC, 110 V AC, 230 V AC
- 5/2
- Qn = 1500 l/min
- Pilot valve width : 15 mm
- Pipe connection
- Compressed air connection output : G 1/4
- Electrical connection : Plug, ISO 15217, form C
- Manual override : with detent
- single solenoid double solenoid
- Pilot : Internal External



Version	Spool valve, positive overlapping
Activation	Electrically
Sealing principle	Soft sealing
Working pressure min./max.	See table below
Control pressure min./max.	See table below
Ambient temperature min./max.	-10 ... 50 °C
Medium temperature min./max.	-10 ... 50 °C
Medium	Compressed air
Max. particle size	5 µm
Oil content of compressed air	0 ... 5 mg/m ³
Nominal flow Qn	1500 l/min
Connector standard	ISO 15217
Protection class with connection	IP65
Duty cycle	100 %
Generic emission standard in accordance with	EN 50081:1992
Mounting on manifold strip	P-strip
Mounting screw tightening torque	2.5 Nm
Weight	See table below
Comment	An example configuration is illustrated. The delivered product may thus deviate from the illustration.

Technical data

Part No.		MO	Compressed air connection	
			Input	Output
R422000116			G 1/4	G 1/4
0820058002			G 1/4	G 1/4
0820058003			G 1/4	G 1/4
0820058052			G 1/4	G 1/4
0820058053			G 1/4	G 1/4
R422000118			G 1/4	G 1/4
0820058027			G 1/4	G 1/4
0820058028			G 1/4	G 1/4
0820058077			G 1/4	G 1/4
0820058078			G 1/4	G 1/4
R422000120			G 1/4	G 1/4
0820058502			G 1/4	G 1/4
0820058503			G 1/4	G 1/4
0820058552			G 1/4	G 1/4
0820058553			G 1/4	G 1/4

Part No.	Compressed air connection	
	Exhaust	Pilot Input
R422000116	G 1/4	-
0820058002	G 1/4	-
0820058003	G 1/4	-
0820058052	G 1/4	M5
0820058053	G 1/4	M5
R422000118	G 1/4	-
0820058027	G 1/4	-
0820058028	G 1/4	-
0820058077	G 1/4	M5
0820058078	G 1/4	M5
R422000120	G 1/4	-
0820058502	G 1/4	-
0820058503	G 1/4	-
0820058552	G 1/4	M5
0820058553	G 1/4	M5

Part No.	Operational voltage		Voltage tolerance
	AC 50 Hz	AC 60 Hz	AC 50 Hz
R422000116	24 V	24 V	-10% / +10%
0820058002	110 V	110 V	-10% / +10%
0820058003	230 V	230 V	-10% / +10%
0820058052	110 V	110 V	-10% / +10%
0820058053	230 V	230 V	-10% / +10%
R422000118	24 V	24 V	-10% / +10%
0820058027	110 V	110 V	-10% / +10%
0820058028	230 V	230 V	-10% / +10%
0820058077	110 V	110 V	-10% / +10%

Part No.	Operational voltage	Operational voltage	Voltage tolerance
	AC 50 Hz	AC 60 Hz	AC 50 Hz
0820058078	230 V	230 V	-10% / +10%
R422000120	24 V	24 V	-10% / +10%
0820058502	110 V	110 V	-10% / +10%
0820058503	230 V	230 V	-10% / +10%
0820058552	110 V	110 V	-10% / +10%
0820058553	230 V	230 V	-10% / +10%

Part No.	Voltage tolerance	Holding power	Holding power	Switch-on power
	AC 60 Hz	AC 50 Hz	AC 60 Hz	AC 50 Hz
R422000116	-10% / +10%	1.6 VA	1.4 VA	2.2 VA
0820058002	-10% / +10%	1.6 VA	1.4 VA	2.2 VA
0820058003	-10% / +10%	1.6 VA	1.4 VA	2.2 VA
0820058052	-10% / +10%	1.6 VA	1.4 VA	2.2 VA
0820058053	-10% / +10%	1.6 VA	1.4 VA	2.2 VA
R422000118	-10% / +10%	1.6 VA	1.4 VA	2.2 VA
0820058027	-10% / +10%	1.6 VA	1.4 VA	2.2 VA
0820058028	-10% / +10%	1.6 VA	1.4 VA	2.2 VA
0820058077	-10% / +10%	1.6 VA	1.4 VA	2.2 VA
0820058078	-10% / +10%	1.6 VA	1.4 VA	2.2 VA
R422000120	-10% / +10%	1.6 VA	1.4 VA	2.2 VA
0820058502	-10% / +10%	1.6 VA	1.4 VA	2.2 VA
0820058503	-10% / +10%	1.6 VA	1.4 VA	2.2 VA
0820058552	-10% / +10%	1.6 VA	1.4 VA	2.2 VA
0820058553	-10% / +10%	1.6 VA	1.4 VA	2.2 VA

Part No.	Switch-on power	Pilot	Flow conductance	Flow conductance	Nominal resistance
	AC 60 Hz		b	C-value	
R422000116	2 VA	Internal	0.33	6.8 l/(s*bar)	185 Ω
0820058002	2 VA	Internal	0.33	6.8 l/(s*bar)	3700 Ω
0820058003	2 VA	Internal	0.33	6.8 l/(s*bar)	14700 Ω
0820058052	2 VA	External	0.33	6.8 l/(s*bar)	3700 Ω
0820058053	2 VA	External	0.33	6.8 l/(s*bar)	14700 Ω
R422000118	2 VA	Internal	0.33	6.8 l/(s*bar)	185 Ω
0820058027	2 VA	Internal	0.33	6.8 l/(s*bar)	3700 Ω
0820058028	2 VA	Internal	0.33	6.8 l/(s*bar)	14700 Ω
0820058077	2 VA	External	0.33	6.8 l/(s*bar)	3700 Ω
0820058078	2 VA	External	0.33	6.8 l/(s*bar)	14700 Ω
R422000120	2 VA	Internal	0.33	6.8 l/(s*bar)	185 Ω
0820058502	2 VA	Internal	0.33	6.8 l/(s*bar)	3700 Ω
0820058503	2 VA	Internal	0.33	6.8 l/(s*bar)	14700 Ω
0820058552	2 VA	External	0.33	6.8 l/(s*bar)	3700 Ω
0820058553	2 VA	External	0.33	6.8 l/(s*bar)	14700 Ω

Part No.	Working pressure min./max.	Control pressure min./max.	Typ. switch-on time	Typ. switch-off time
R422000116	2.5 ... 10 bar	2.5 ... 10 bar	21 ms	22 ms
0820058002	2.5 ... 10 bar	2.5 ... 10 bar	21 ms	22 ms
0820058003	2.5 ... 10 bar	2.5 ... 10 bar	21 ms	22 ms

Part No.	Working pressure min./max.	Control pressure min./max.	Typ. switch-on time	Typ. switch-off time
0820058052	-0.9 ... 10 bar	2.5 ... 10 bar	21 ms	22 ms
0820058053	-0.9 ... 10 bar	2.5 ... 10 bar	21 ms	22 ms
R422000118	3 ... 10 bar	3 ... 10 bar	12 ms	35 ms
0820058027	3 ... 10 bar	3 ... 10 bar	12 ms	35 ms
0820058028	3 ... 10 bar	3 ... 10 bar	12 ms	35 ms
0820058077	-0.9 ... 10 bar	3 ... 10 bar	12 ms	35 ms
0820058078	-0.9 ... 10 bar	3 ... 10 bar	12 ms	35 ms
R422000120	2 ... 10 bar	2 ... 10 bar	10 ms	10 ms
0820058502	2 ... 10 bar	2 ... 10 bar	10 ms	10 ms
0820058503	2 ... 10 bar	2 ... 10 bar	10 ms	10 ms
0820058552	-0.9 ... 10 bar	2 ... 10 bar	10 ms	10 ms
0820058553	-0.9 ... 10 bar	2 ... 10 bar	10 ms	10 ms

Part No.	Weight
R422000116	0.235 kg
0820058002	0.235 kg
0820058003	0.235 kg
0820058052	0.235 kg
0820058053	0.235 kg
R422000118	0.235 kg
0820058027	0.235 kg
0820058028	0.235 kg
0820058077	0.235 kg
0820058078	0.235 kg
R422000120	0.263 kg
0820058502	0.263 kg
0820058503	0.263 kg
0820058552	0.263 kg
0820058553	0.263 kg

Nominal flow Q_n at 6 bar and $\Delta p = 1$ bar, MO = Manual override

Technical information

The min. control pressure must be adhered to, since otherwise faulty switching and valve failure may result!

The pressure dew point must be at least 15 °C under ambient and medium temperature and may not exceed 3 °C .

The oil content of compressed air must remain constant during the life cycle.

Use only the approved oils from AVENTICS. Further information can be found in the "Technical information" document (available in the MediaCentre).

Technical information

Material	
Housing	Polyamide fiber-glass reinforced
Seals	Acrylonitrile butadiene rubber Hydrogenated nitrile butadiene rubber
Front plate	Polyamide fiber-glass reinforced

Material	
Threaded bushing	Brass Die cast zinc, nickel-plated chrome-plated

Dimensions

Dimensions, single solenoid

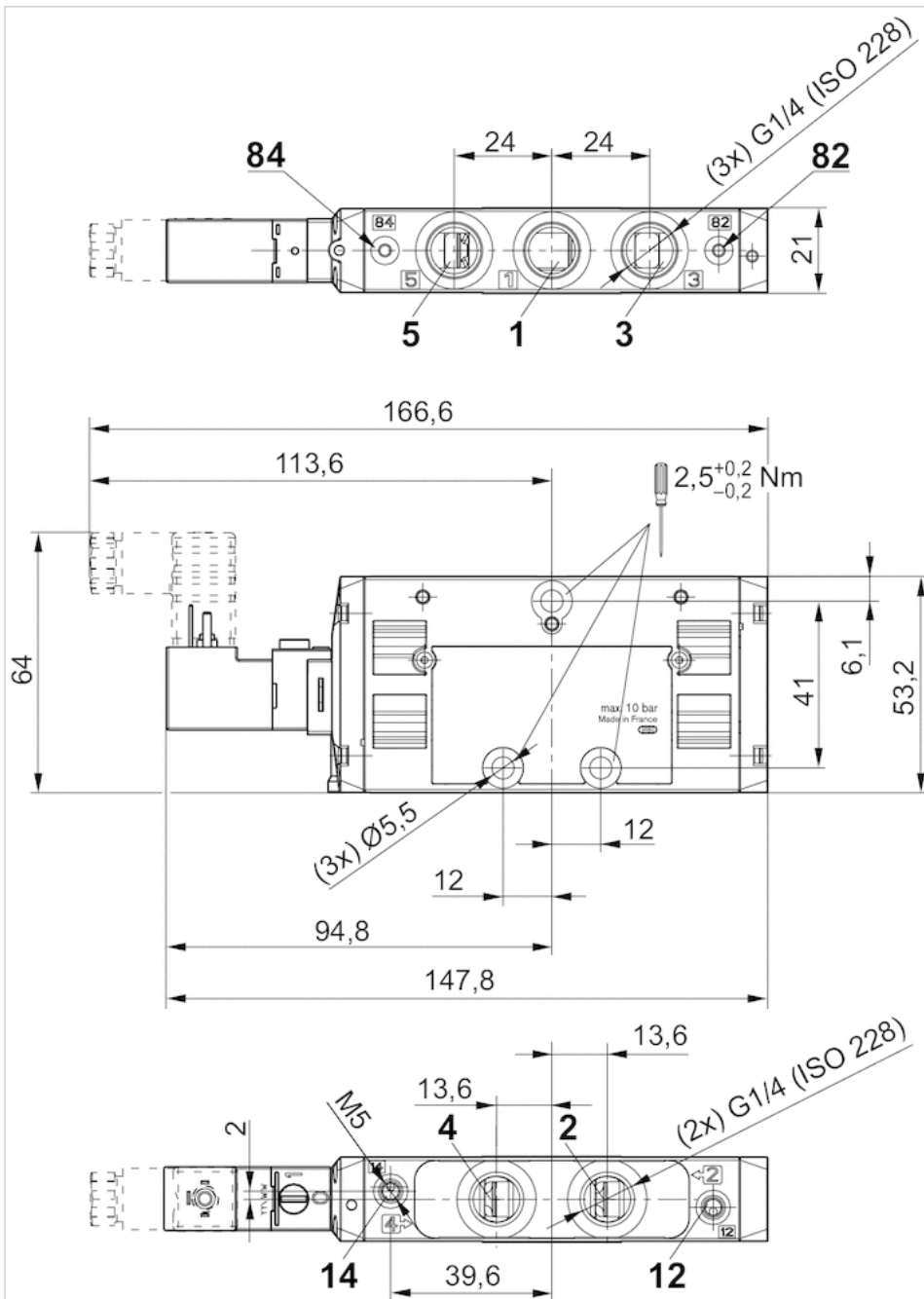











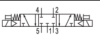

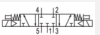





5/3-directional valve, Series TC15

- Operating voltage 24 V DC
- 5/3
- $Q_n = 1300$ l/min
- Pilot valve width : 15 mm
- closed center exhausted center pressurized center
- Pipe connection
- Compressed air connection output : G 1/4
- Electrical connection : Plug, ISO 15217, form C
- Manual override : without detent
- double solenoid
- Pilot : Internal External

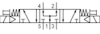

Version	Spool valve, positive overlapping
Activation	Electrically
Sealing principle	Soft sealing
Working pressure min./max.	See table below
Control pressure min./max.	3 ... 10 bar
Ambient temperature min./max.	-10 ... 50 °C
Medium temperature min./max.	-10 ... 50 °C
Medium	Compressed air
Max. particle size	5 µm
Oil content of compressed air	0 ... 5 mg/m ³
Nominal flow Q_n	1300 l/min
Connector standard	ISO 15217
Protection class with connection	IP65
Duty cycle	100 %
Typ. switch-on time	12 ms
Typ. switch-off time	13 ms
Mounting on manifold strip	P-strip
Mounting screw tightening torque	2.5 Nm
Weight	0.278 kg

Technical data

Part No.		MO		Compressed air connection	
					Input
0820059101				closed center	G 1/4
R422103072				closed center	G 1/4
0820059151				closed center	G 1/4
R422103074				closed center	G 1/4
0820059111				exhausted center	G 1/4
R422103076				exhausted center	G 1/4
0820059161				exhausted center	G 1/4
0820059171				pressurized center	G 1/4
0820059121				pressurized center	G 1/4

Part No.	Compressed air connection	
	Output	Exhaust
0820059101	G 1/4	G 1/4
R422103072	G 1/4	G 1/4
0820059151	G 1/4	G 1/4
R422103074	G 1/4	G 1/4
0820059111	G 1/4	G 1/4
R422103076	G 1/4	G 1/4
0820059161	G 1/4	G 1/4
0820059171	G 1/4	G 1/4
0820059121	G 1/4	G 1/4

Part No.	Compressed air connection		Operational voltage	
	Pilot Input		DC	DC
0820059101	-		24 V	-10% / +10%
R422103072	-		-	-
0820059151	M5		24 V	-10% / +10%
R422103074	M5		-	-
0820059111	-		24 V	-10% / +10%
R422103076	-		-	-
0820059161	M5		24 V	-10% / +10%
0820059171	M5		24 V	-10% / +10%
0820059121	-		24 V	-10% / +10%

Part No.	Power consumption		Pilot	Flow conductance		Nominal resistance
	DC			b	C-value	
0820059101	2 W		Internal	0.31	5.9 l/(s*bar)	280 Ω
R422103072	-		Internal	0.31	5.9 l/(s*bar)	-
0820059151	2 W		External	0.31	5.9 l/(s*bar)	280 Ω
R422103074	-		External	0.31	5.9 l/(s*bar)	-
0820059111	2 W		Internal	0.31	5.9 l/(s*bar)	280 Ω
R422103076	-		Internal	0.31	5.9 l/(s*bar)	-
0820059161	2 W		External	0.31	5.9 l/(s*bar)	280 Ω
0820059171	2 W		External	0.31	5.9 l/(s*bar)	280 Ω
0820059121	2 W		Internal	0.31	5.9 l/(s*bar)	280 Ω

Part No.	Working pressure min./max.	basic valve with electrical connector
0820059101	3 ... 10 bar	-
R422103072	3 ... 10 bar	Basic valve without coil
0820059151	-0.9 ... 10 bar	-
R422103074	-0.9 ... 10 bar	Basic valve without coil
0820059111	3 ... 10 bar	-
R422103076	3 ... 10 bar	Basic valve without coil
0820059161	-0.9 ... 10 bar	-
0820059171	-0.9 ... 10 bar	-
0820059121	3 ... 10 bar	-

Nominal flow Qn at 6 bar and $\Delta p = 1$ bar, MO = Manual override

Technical information

The min. control pressure must be adhered to, since otherwise faulty switching and valve failure may result!

The pressure dew point must be at least 15 °C under ambient and medium temperature and may not exceed 3 °C .

The oil content of compressed air must remain constant during the life cycle.

Use only the approved oils from AVENTICS. Further information can be found in the "Technical information" document (available in the MediaCentre).

Technical information

Material	
Housing	Polyamide fiber-glass reinforced
Seals	Acrylonitrile butadiene rubber Hydrogenated nitrile butadiene rubber
Front plate	Polyamide fiber-glass reinforced
Threaded bushing	Brass Die cast zinc, nickel-plated chrome-plated

Dimensions

Dimensions

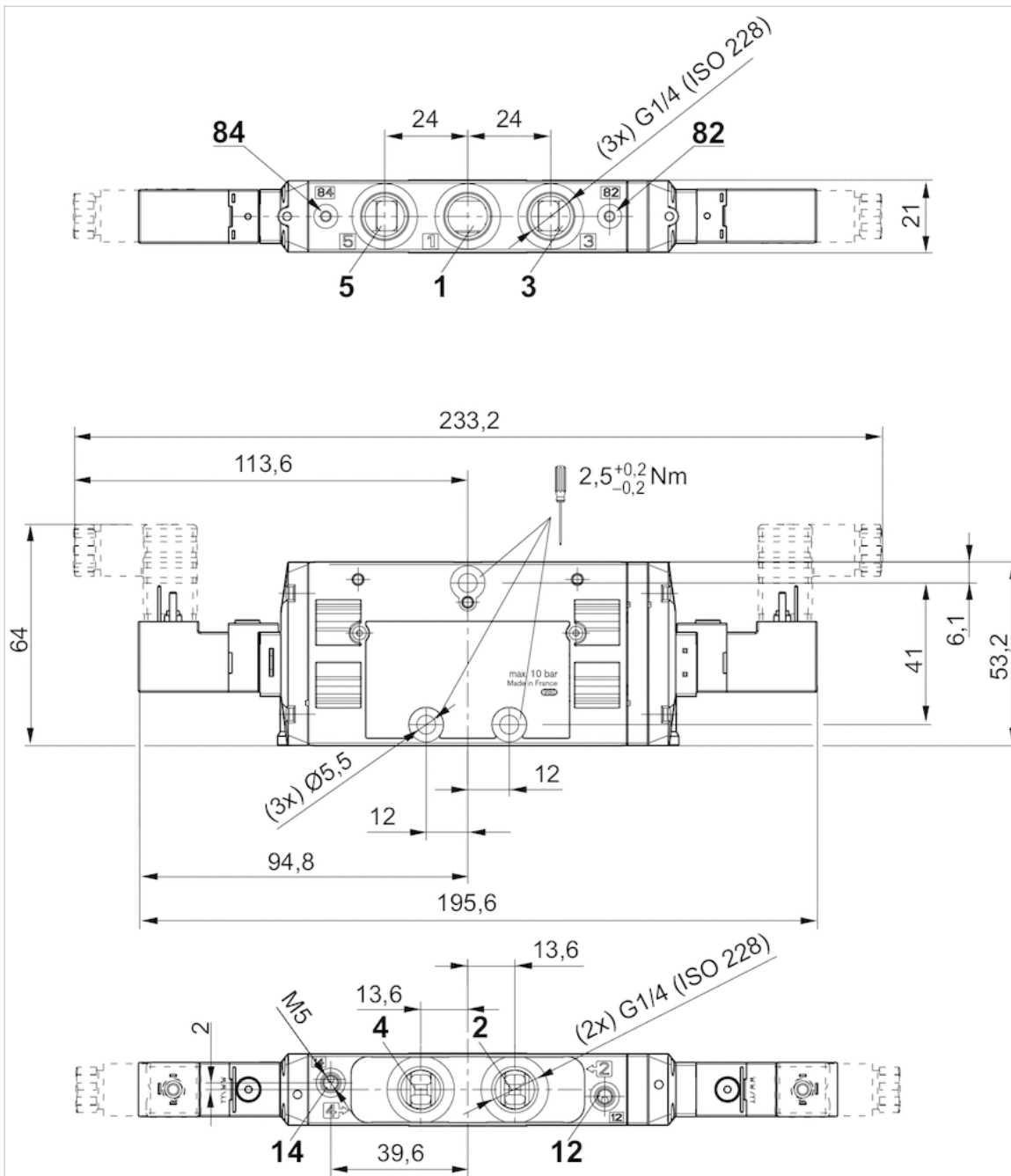











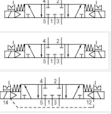
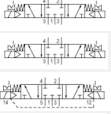

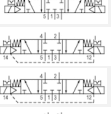

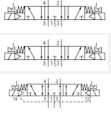

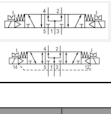

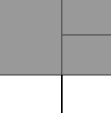
5/3-directional valve, Series TC15

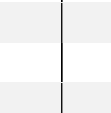
- Operating voltage 24 V DC
- 5/3
- $Q_n = 1300$ l/min
- Pilot valve width : 15 mm
- closed center exhausted center pressurized center
- Pipe connection
- Compressed air connection output : G 1/4
- Electrical connection : Plug, ISO 15217, form C
- Manual override : with detent
- double solenoid
- Pilot : Internal External

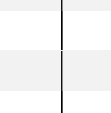

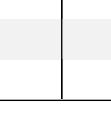
Version	Spool valve, positive overlapping
Activation	Electrically
Sealing principle	Soft sealing
Working pressure min./max.	See table below
Control pressure min./max.	3 ... 10 bar
Ambient temperature min./max.	-10 ... 50 °C
Medium temperature min./max.	-10 ... 50 °C
Medium	Compressed air
Max. particle size	5 µm
Oil content of compressed air	0 ... 5 mg/m ³
Nominal flow Q_n	1300 l/min
Connector standard	ISO 15217
Protection class with connection	IP65
Duty cycle	100 %
Typ. switch-on time	12 ms
Typ. switch-off time	13 ms
Mounting on manifold strip	P-strip
Mounting screw tightening torque	2.5 Nm
Weight	0.278 kg

Technical data

Part No.		MO		Compressed air connection	
				Input	
0820059001				closed center	G 1/4
R422103071				closed center	G 1/4
0820059051				closed center	G 1/4
R422103073				closed center	G 1/4
0820059011				exhausted center	G 1/4
R422103075				exhausted center	G 1/4
0820059061				exhausted center	G 1/4
0820059021				pressurized center	G 1/4
0820059071				pressurized center	G 1/4

Part No.	Compressed air connection	
	Output	Exhaust
0820059001	G 1/4	G 1/4
R422103071	G 1/4	G 1/4
0820059051	G 1/4	G 1/4
R422103073	G 1/4	G 1/4
0820059011	G 1/4	G 1/4
R422103075	G 1/4	G 1/4
0820059061	G 1/4	G 1/4
0820059021	G 1/4	G 1/4
0820059071	G 1/4	G 1/4

Part No.	Compressed air connection		Operational voltage	
	Pilot Input		DC	DC
0820059001	-		24 V	-10% / +10%
R422103071	-		-	-
0820059051	M5		24 V	-10% / +10%
R422103073	M5		-	-
0820059011	-		24 V	-10% / +10%
R422103075	-		-	-
0820059061	M5		24 V	-10% / +10%
0820059021	-		24 V	-10% / +10%
0820059071	M5		24 V	-10% / +10%

Part No.	Power consumption		Pilot	Flow conductance		Nominal resistance
	DC			b	C-value	
0820059001	2 W		Internal	0.31	5.9 l/(s*bar)	280 Ω
R422103071	-		Internal	0.31	5.9 l/(s*bar)	-
0820059051	2 W		External	0.31	5.9 l/(s*bar)	280 Ω
R422103073	-		External	0.31	5.9 l/(s*bar)	-
0820059011	2 W		Internal	0.31	5.9 l/(s*bar)	280 Ω
R422103075	-		Internal	0.31	5.9 l/(s*bar)	-
0820059061	2 W		External	0.31	5.9 l/(s*bar)	280 Ω
0820059021	2 W		Internal	0.31	5.9 l/(s*bar)	280 Ω
0820059071	2 W		External	0.31	5.9 l/(s*bar)	280 Ω

Part No.	Working pressure min./max.	basic valve with electrical connector
0820059001	3 ... 10 bar	-
R422103071	3 ... 10 bar	Basic valve without coil
0820059051	-0.9 ... 10 bar	-
R422103073	-0.9 ... 10 bar	Basic valve without coil
0820059011	3 ... 10 bar	-
R422103075	3 ... 10 bar	Basic valve without coil
0820059061	-0.9 ... 10 bar	-
0820059021	3 ... 10 bar	-
0820059071	-0.9 ... 10 bar	-

Nominal flow Qn at 6 bar and $\Delta p = 1$ bar, MO = Manual override

Technical information

The min. control pressure must be adhered to, since otherwise faulty switching and valve failure may result!

The pressure dew point must be at least 15 °C under ambient and medium temperature and may not exceed 3 °C .

The oil content of compressed air must remain constant during the life cycle.

Use only the approved oils from AVENTICS. Further information can be found in the "Technical information" document (available in the MediaCentre).

Technical information

Material	
Housing	Polyamide fiber-glass reinforced
Seals	Acrylonitrile butadiene rubber Hydrogenated nitrile butadiene rubber
Front plate	Polyamide fiber-glass reinforced
Threaded bushing	Brass Die cast zinc, nickel-plated chrome-plated

Dimensions

Dimensions

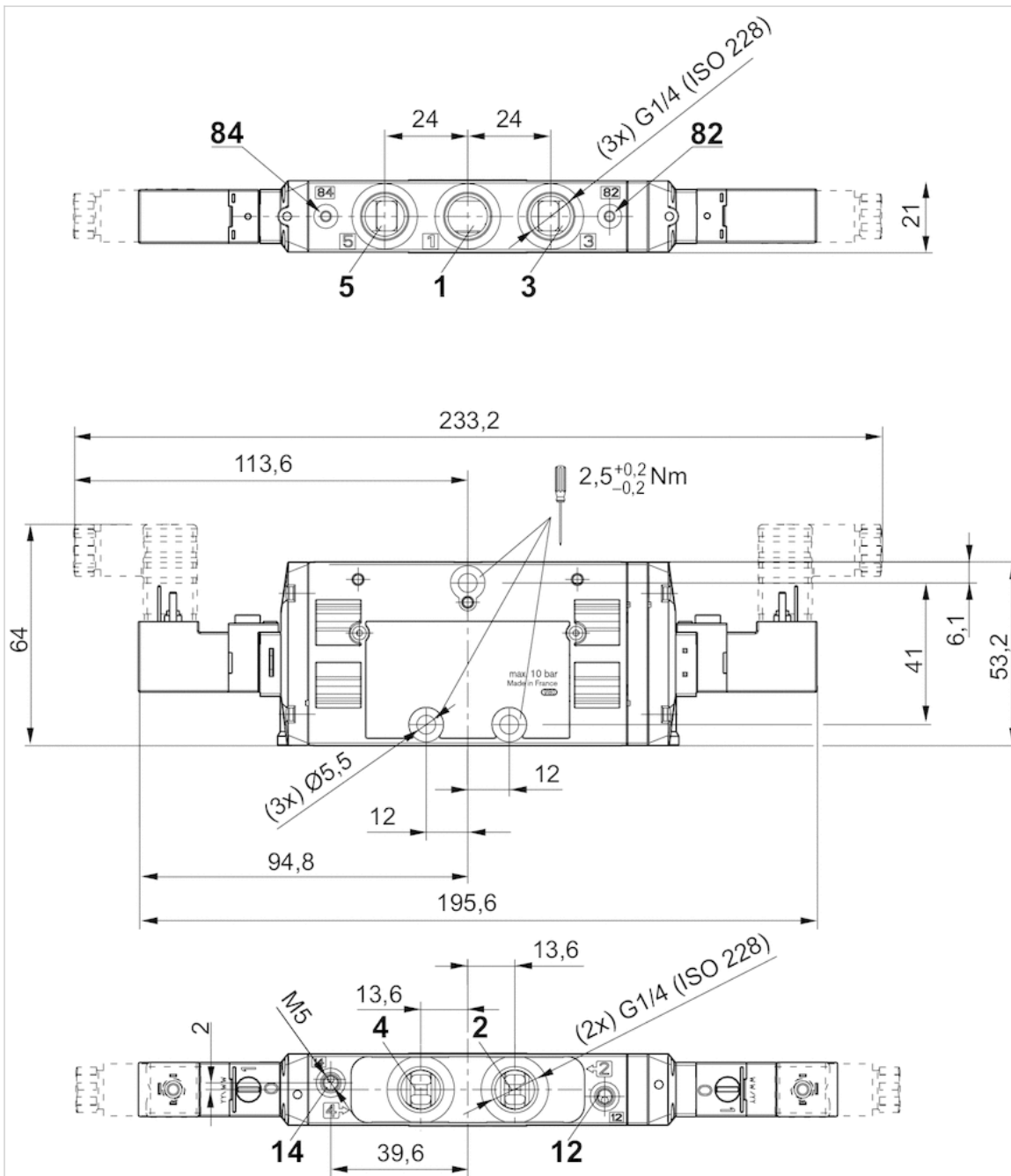















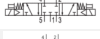

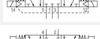











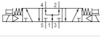

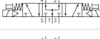
5/3-directional valve, Series TC15

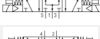
- Operating voltage 24 V AC, 110 V AC, 230 V AC
- 5/3
- Qn = 1300 l/min
- Pilot valve width : 15 mm
- closed center exhausted center pressurized center
- Pipe connection
- Compressed air connection output : G 1/4
- Electrical connection : Plug, ISO 15217, form C
- Manual override : without detent
- double solenoid
- Pilot : Internal External

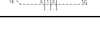

Version	Spool valve, positive overlapping
Activation	Electrically
Sealing principle	Soft sealing
Working pressure min./max.	See table below
Control pressure min./max.	3 ... 10 bar
Ambient temperature min./max.	-10 ... 50 °C
Medium temperature min./max.	-10 ... 50 °C
Medium	Compressed air
Max. particle size	5 µm
Oil content of compressed air	0 ... 5 mg/m ³
Nominal flow Qn	1300 l/min
Connector standard	ISO 15217
Protection class with connection	IP65
Duty cycle	100 %
Typ. switch-on time	12 ms
Typ. switch-off time	13 ms
Generic emission standard in accordance with	EN 50081:1992
Mounting on manifold strip	P-strip
Mounting screw tightening torque	2.5 Nm
Weight	0.278 kg

Technical data

Part No.		MO	Compressed air connection	
				Input
R422000123			closed center	G 1/4
0820059102			closed center	G 1/4
0820059103			closed center	G 1/4
0820059152			closed center	G 1/4
0820059153			closed center	G 1/4
R422000125			exhausted center	G 1/4
0820059112			exhausted center	G 1/4
0820059113			exhausted center	G 1/4
0820059162			exhausted center	G 1/4
0820059163			exhausted center	G 1/4
R422000127			pressurized center	G 1/4
0820059122			pressurized center	G 1/4
0820059123			pressurized center	G 1/4
0820059172			pressurized center	G 1/4
0820059173			pressurized center	G 1/4

Part No.	Compressed air connection	
	Output	Exhaust
R422000123	G 1/4	G 1/4
0820059102	G 1/4	G 1/4
0820059103	G 1/4	G 1/4
0820059152	G 1/4	G 1/4
0820059153	G 1/4	G 1/4
R422000125	G 1/4	G 1/4
0820059112	G 1/4	G 1/4
0820059113	G 1/4	G 1/4
0820059162	G 1/4	G 1/4
0820059163	G 1/4	G 1/4
R422000127	G 1/4	G 1/4
0820059122	G 1/4	G 1/4
0820059123	G 1/4	G 1/4
0820059172	G 1/4	G 1/4
0820059173	G 1/4	G 1/4

Part No.	Compressed air connection		Operational voltage	
	Pilot Input		AC 50 Hz	AC 60 Hz
R422000123	-		24 V	24 V
0820059102	-		110 V	110 V
0820059103	-		230 V	230 V
0820059152	M5		110 V	110 V
0820059153	M5		230 V	230 V
R422000125	-		24 V	24 V
0820059112	-		110 V	110 V
0820059113	-		230 V	230 V
0820059162	M5		110 V	110 V

Part No.	Compressed air connection	Operational voltage	Operational voltage
	Pilot Input	AC 50 Hz	AC 60 Hz
0820059163	M5	230 V	230 V
R422000127	-	24 V	24 V
0820059122	-	110 V	110 V
0820059123	-	230 V	230 V
0820059172	M5	110 V	110 V
0820059173	M5	230 V	230 V

Part No.	Voltage tolerance	Voltage tolerance	Holding power	Holding power
	AC 50 Hz	AC 60 Hz	AC 50 Hz	AC 60 Hz
R422000123	-10% / +10%	-10% / +10%	1.6 VA	1.4 VA
0820059102	-10% / +10%	-10% / +10%	1.6 VA	1.4 VA
0820059103	-10% / +10%	-10% / +10%	1.6 VA	1.4 VA
0820059152	-10% / +10%	-10% / +10%	1.6 VA	1.4 VA
0820059153	-10% / +10%	-10% / +10%	1.6 VA	1.4 VA
R422000125	-10% / +10%	-10% / +10%	1.6 VA	1.4 VA
0820059112	-10% / +10%	-10% / +10%	1.6 VA	1.4 VA
0820059113	-10% / +10%	-10% / +10%	1.6 VA	1.4 VA
0820059162	-10% / +10%	-10% / +10%	1.6 VA	1.4 VA
0820059163	-10% / +10%	-10% / +10%	1.6 VA	1.4 VA
R422000127	-10% / +10%	-10% / +10%	1.6 VA	1.4 VA
0820059122	-10% / +10%	-10% / +10%	1.6 VA	1.4 VA
0820059123	-10% / +10%	-10% / +10%	1.6 VA	1.4 VA
0820059172	-10% / +10%	-10% / +10%	1.6 VA	1.4 VA
0820059173	-10% / +10%	-10% / +10%	1.6 VA	1.4 VA

Part No.	Switch-on power	Switch-on power	Pilot	Flow conductance
	AC 50 Hz	AC 60 Hz		b
R422000123	2.2 VA	2 VA	Internal	0.31
0820059102	2.2 VA	2 VA	Internal	0.31
0820059103	2.2 VA	2 VA	Internal	0.31
0820059152	2.2 VA	2 VA	External	0.31
0820059153	2.2 VA	2 VA	External	0.31
R422000125	2.2 VA	2 VA	Internal	0.31
0820059112	2.2 VA	2 VA	Internal	0.31
0820059113	2.2 VA	2 VA	Internal	0.31
0820059162	2.2 VA	2 VA	External	0.31
0820059163	2.2 VA	2 VA	External	0.31
R422000127	2.2 VA	2 VA	Internal	0.31
0820059122	2.2 VA	2 VA	Internal	0.31
0820059123	2.2 VA	2 VA	Internal	0.31
0820059172	2.2 VA	2 VA	External	0.31
0820059173	2.2 VA	2 VA	External	0.31

Part No.	Flow conductance	Nominal resistance	Working pressure min./max.
	C-value		
R422000123	5.9 l/(s*bar)	185 Ω	3 ... 10 bar
0820059102	5.9 l/(s*bar)	3700 Ω	3 ... 10 bar
0820059103	5.9 l/(s*bar)	14700 Ω	3 ... 10 bar

Part No.	Flow conductance	Nominal resistance	Working pressure min./max.
	C-value		
0820059152	5.9 l/(s*bar)	3700 Ω	-0.9 ... 10 bar
0820059153	5.9 l/(s*bar)	14700 Ω	-0.9 ... 10 bar
R422000125	5.9 l/(s*bar)	185 Ω	3 ... 10 bar
0820059112	5.9 l/(s*bar)	3700 Ω	3 ... 10 bar
0820059113	5.9 l/(s*bar)	14700 Ω	3 ... 10 bar
0820059162	5.9 l/(s*bar)	3700 Ω	-0.9 ... 10 bar
0820059163	5.9 l/(s*bar)	14700 Ω	-0.9 ... 10 bar
R422000127	5.9 l/(s*bar)	185 Ω	3 ... 10 bar
0820059122	5.9 l/(s*bar)	3700 Ω	3 ... 10 bar
0820059123	5.9 l/(s*bar)	14700 Ω	3 ... 10 bar
0820059172	5.9 l/(s*bar)	3700 Ω	-0.9 ... 10 bar
0820059173	5.9 l/(s*bar)	14700 Ω	-0.9 ... 10 bar

Nominal flow Q_n at 6 bar and $\Delta p = 1$ bar, MO = Manual override

Technical information

The min. control pressure must be adhered to, since otherwise faulty switching and valve failure may result!

The pressure dew point must be at least 15 °C under ambient and medium temperature and may not exceed 3 °C .

The oil content of compressed air must remain constant during the life cycle.

Use only the approved oils from AVENTICS. Further information can be found in the "Technical information" document (available in the MediaCentre).

Technical information

Material	
Housing	Polyamide fiber-glass reinforced
Seals	Acrylonitrile butadiene rubber Hydrogenated nitrile butadiene rubber
Front plate	Polyamide fiber-glass reinforced
Threaded bushing	Brass Die cast zinc, nickel-plated chrome-plated

Dimensions

Dimensions

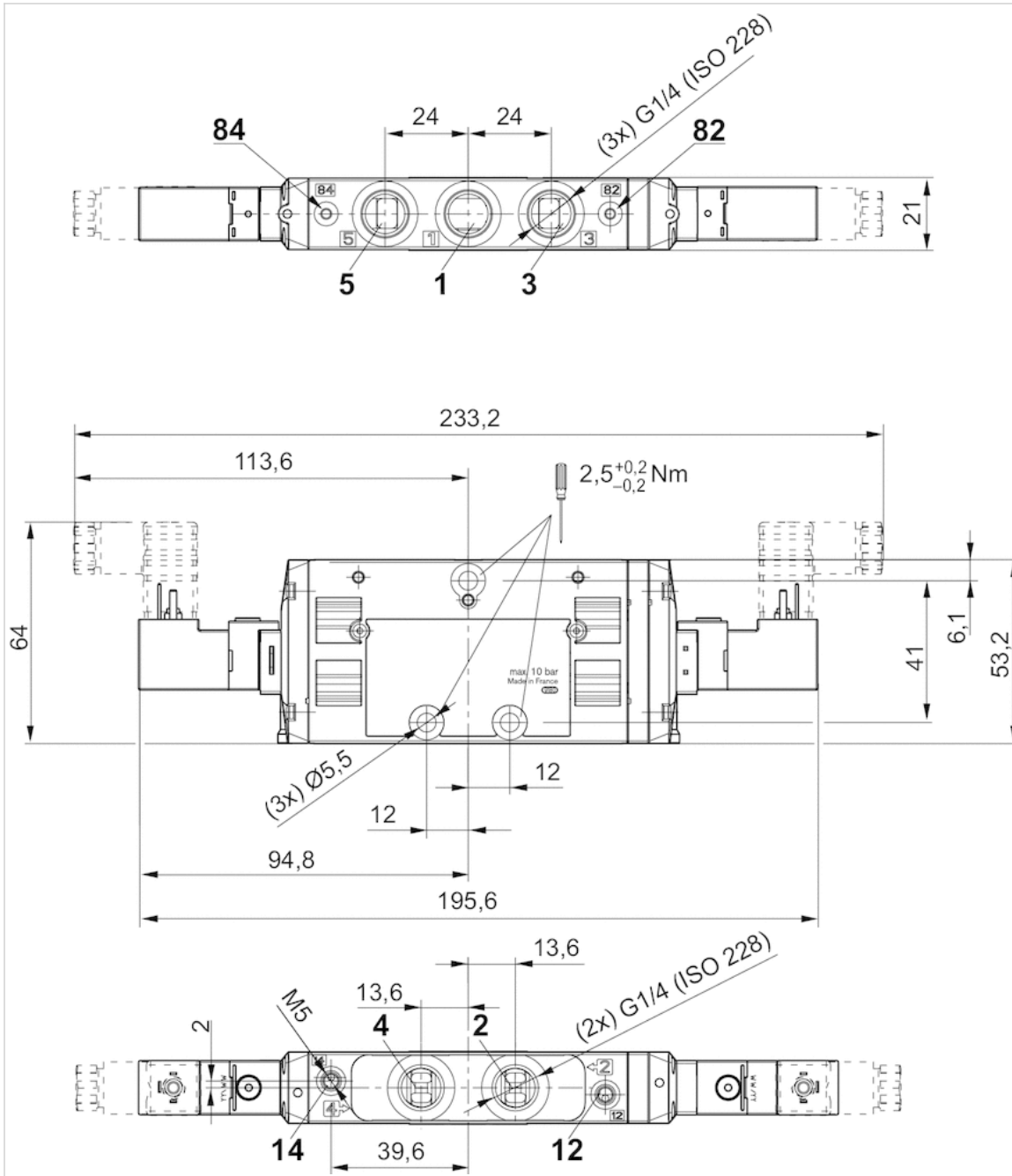

5/3-directional valve, Series TC15

- Operating voltage 24 V AC, 110 V AC, 230 V AC
- 5/3
- $Q_n = 1300$ l/min
- Pilot valve width : 15 mm
- closed center exhausted center pressurized center
- Pipe connection
- Compressed air connection output : G 1/4
- Electrical connection : Plug, ISO 15217, form C
- Manual override : with detent
- double solenoid
- Pilot : Internal External



Version	Spool valve, positive overlapping
Activation	Electrically
Sealing principle	Soft sealing
Working pressure min./max.	See table below
Control pressure min./max.	3 ... 10 bar
Ambient temperature min./max.	-10 ... 50 °C
Medium temperature min./max.	-10 ... 50 °C
Medium	Compressed air
Max. particle size	5 µm
Oil content of compressed air	0 ... 5 mg/m ³
Nominal flow Q_n	1300 l/min
Connector standard	ISO 15217
Protection class with connection	IP65
Duty cycle	100 %
Typ. switch-on time	12 ms
Typ. switch-off time	13 ms
Generic emission standard in accordance with	EN 50081:1992
Mounting on manifold strip	P-strip
Mounting screw tightening torque	2.5 Nm
Weight	0.278 kg

Technical data

Part No.		MO		Compressed air connection	
					Input
R422000122			closed center		G 1/4
0820059002			closed center		G 1/4
0820059003			closed center		G 1/4
0820059052			closed center		G 1/4
0820059053			closed center		G 1/4
R422000124			exhausted center		G 1/4
0820059012			exhausted center		G 1/4
0820059013			exhausted center		G 1/4
0820059062			exhausted center		G 1/4
0820059063			exhausted center		G 1/4
R422000126			pressurized center		G 1/4
0820059022			pressurized center		G 1/4
0820059023			pressurized center		G 1/4
0820059073			pressurized center		G 1/4
0820059072			pressurized center		G 1/4

Part No.	Compressed air connection	
	Output	Exhaust
R422000122	G 1/4	G 1/4
0820059002	G 1/4	G 1/4
0820059003	G 1/4	G 1/4
0820059052	G 1/4	G 1/4
0820059053	G 1/4	G 1/4
R422000124	G 1/4	G 1/4
0820059012	G 1/4	G 1/4
0820059013	G 1/4	G 1/4
0820059062	G 1/4	G 1/4
0820059063	G 1/4	G 1/4
R422000126	G 1/4	G 1/4
0820059022	G 1/4	G 1/4
0820059023	G 1/4	G 1/4
0820059073	G 1/4	G 1/4
0820059072	G 1/4	G 1/4

Part No.	Compressed air connection		Operational voltage	
	Pilot Input		AC 50 Hz	AC 60 Hz
R422000122	-		24 V	24 V
0820059002	-		110 V	110 V
0820059003	-		230 V	230 V
0820059052	M5		110 V	110 V
0820059053	M5		230 V	230 V
R422000124	-		24 V	24 V
0820059012	-		110 V	110 V
0820059013	-		230 V	230 V
0820059062	M5		110 V	110 V

Part No.	Compressed air connection	Operational voltage	Operational voltage
	Pilot Input	AC 50 Hz	AC 60 Hz
0820059063	M5	230 V	230 V
R422000126	-	24 V	24 V
0820059022	-	110 V	110 V
0820059023	-	230 V	230 V
0820059073	M5	230 V	230 V
0820059072	M5	110 V	110 V

Part No.	Voltage tolerance	Voltage tolerance	Holding power	Holding power
	AC 50 Hz	AC 60 Hz	AC 50 Hz	AC 60 Hz
R422000122	-10% / +10%	-10% / +10%	1.6 VA	1.4 VA
0820059002	-10% / +10%	-10% / +10%	1.6 VA	1.4 VA
0820059003	-10% / +10%	-10% / +10%	1.6 VA	1.4 VA
0820059052	-10% / +10%	-10% / +10%	1.6 VA	1.4 VA
0820059053	-10% / +10%	-10% / +10%	1.6 VA	1.4 VA
R422000124	-10% / +10%	-10% / +10%	1.6 VA	1.4 VA
0820059012	-10% / +10%	-10% / +10%	1.6 VA	1.4 VA
0820059013	-10% / +10%	-10% / +10%	1.6 VA	1.4 VA
0820059062	-10% / +10%	-10% / +10%	1.6 VA	1.4 VA
0820059063	-10% / +10%	-10% / +10%	1.6 VA	1.4 VA
R422000126	-10% / +10%	-10% / +10%	1.6 VA	1.4 VA
0820059022	-10% / +10%	-10% / +10%	1.6 VA	1.4 VA
0820059023	-10% / +10%	-10% / +10%	1.6 VA	1.4 VA
0820059073	-10% / +10%	-10% / +10%	1.6 VA	1.4 VA
0820059072	-10% / +10%	-10% / +10%	1.6 VA	1.4 VA

Part No.	Switch-on power	Switch-on power	Pilot	Flow conductance
	AC 50 Hz	AC 60 Hz		b
R422000122	2.2 VA	2 VA	Internal	0.31
0820059002	2.2 VA	2 VA	Internal	0.31
0820059003	2.2 VA	2 VA	Internal	0.31
0820059052	2.2 VA	2 VA	External	0.31
0820059053	2.2 VA	2 VA	External	0.31
R422000124	2.2 VA	2 VA	Internal	0.31
0820059012	2.2 VA	2 VA	Internal	0.31
0820059013	2.2 VA	2 VA	Internal	0.31
0820059062	2.2 VA	2 VA	External	0.31
0820059063	2.2 VA	2 VA	External	0.31
R422000126	2.2 VA	2 VA	Internal	0.31
0820059022	2.2 VA	2 VA	Internal	0.31
0820059023	2.2 VA	2 VA	Internal	0.31
0820059073	2.2 VA	2 VA	External	0.31
0820059072	2.2 VA	2 VA	External	0.31

Part No.	Flow conductance	Nominal resistance	Working pressure min./max.
	C-value		
R422000122	5.9 l/(s*bar)	185 Ω	3 ... 10 bar
0820059002	5.9 l/(s*bar)	3700 Ω	3 ... 10 bar
0820059003	5.9 l/(s*bar)	14700 Ω	3 ... 10 bar

Part No.	Flow conductance	Nominal resistance	Working pressure min./max.
	C-value		
0820059052	5.9 l/(s*bar)	3700 Ω	-0.9 ... 10 bar
0820059053	5.9 l/(s*bar)	14700 Ω	-0.9 ... 10 bar
R422000124	5.9 l/(s*bar)	185 Ω	3 ... 10 bar
0820059012	5.9 l/(s*bar)	3700 Ω	3 ... 10 bar
0820059013	5.9 l/(s*bar)	14700 Ω	3 ... 10 bar
0820059062	5.9 l/(s*bar)	3700 Ω	-0.9 ... 10 bar
0820059063	5.9 l/(s*bar)	14700 Ω	-0.9 ... 10 bar
R422000126	5.9 l/(s*bar)	185 Ω	3 ... 10 bar
0820059022	5.9 l/(s*bar)	3700 Ω	3 ... 10 bar
0820059023	5.9 l/(s*bar)	14700 Ω	3 ... 10 bar
0820059073	5.9 l/(s*bar)	14700 Ω	-0.9 ... 10 bar
0820059072	5.9 l/(s*bar)	3700 Ω	-0.9 ... 10 bar

Nominal flow Q_n at 6 bar and $\Delta p = 1$ bar, MO = Manual override

Technical information

The min. control pressure must be adhered to, since otherwise faulty switching and valve failure may result!

The pressure dew point must be at least 15 °C under ambient and medium temperature and may not exceed 3 °C .

The oil content of compressed air must remain constant during the life cycle.

Use only the approved oils from AVENTICS. Further information can be found in the "Technical information" document (available in the MediaCentre).

Technical information

Material	
Housing	Polyamide fiber-glass reinforced
Seals	Acrylonitrile butadiene rubber Hydrogenated nitrile butadiene rubber
Front plate	Polyamide fiber-glass reinforced
Threaded bushing	Brass Die cast zinc, nickel-plated chrome-plated

Dimensions

Dimensions

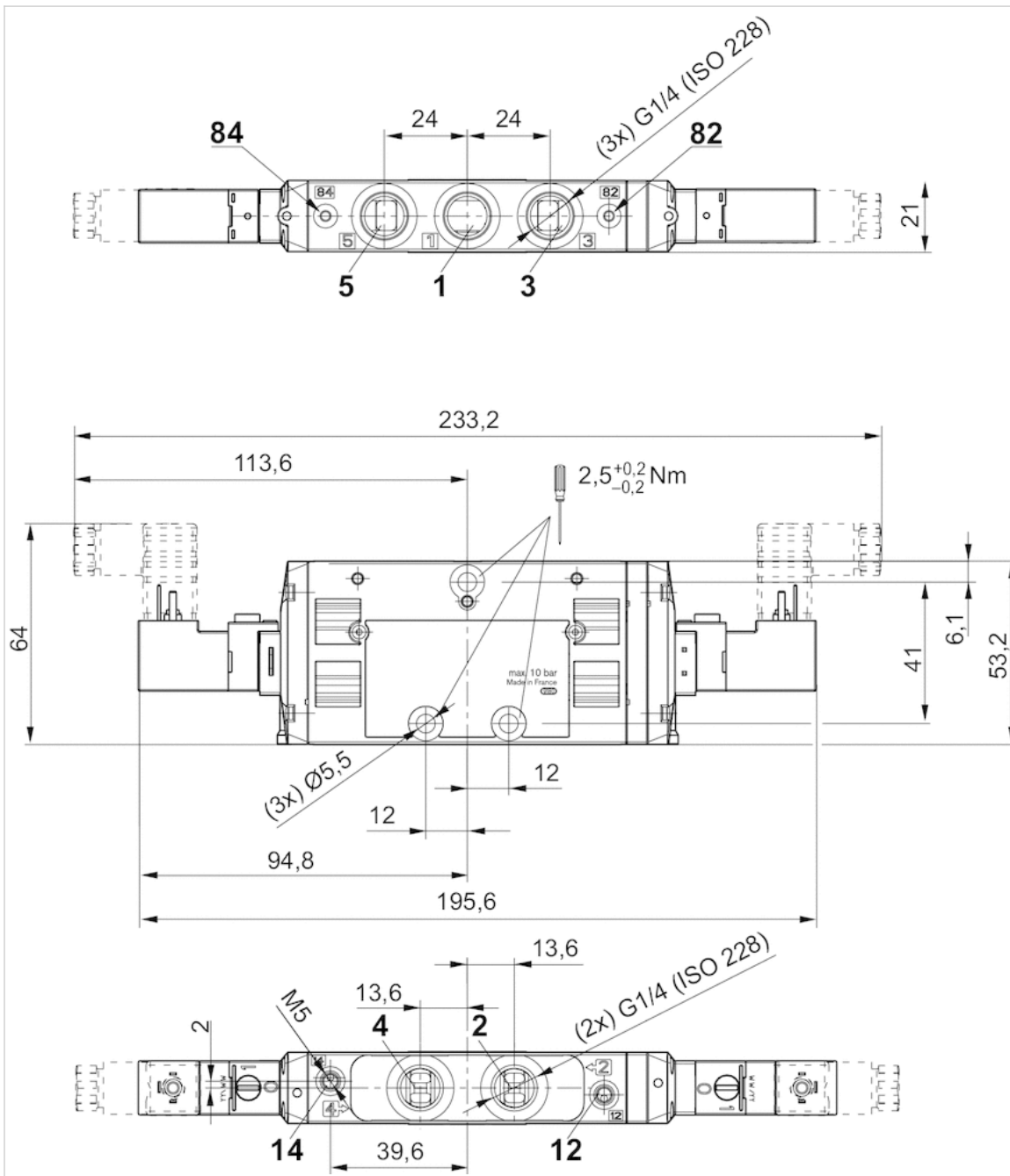





































2x3/2-directional valve, Series TC15 - inch

- Operating voltage 12 V AC, 110 V AC, 230 V AC
- 2x3/2
- $Q_n = 1100$ l/min
- Pilot valve width : 15 mm
- NC/NC NO/NO NC/NO
- Pipe connection
- Compressed air connection output : 1/4 - 18 NPTF
- Electrical connection : Plug, ISO 15217, form C
- Manual override : with detent
- double solenoid
- With spring return
- Pilot : Internal External



Version	Spool valve, positive overlapping
Activation	Electrically
Sealing principle	Soft sealing
Working pressure min./max.	See table below
Control pressure min./max.	3 ... 10 bar
Ambient temperature min./max.	-10 ... 50 °C
Medium temperature min./max.	-10 ... 50 °C
Medium	Compressed air
Max. particle size	5 µm
Oil content of compressed air	0 ... 5 mg/m ³
Nominal flow Q_n	1100 l/min
Compressed air connection	according to ANSI B1.20.3
Connector standard	ISO 15217
Protection class with connection	IP65
Duty cycle	100 %
Typ. switch-on time	12 ms
Typ. switch-off time	16 ms
Generic emission standard in accordance with	EN 50081-2:1993
Mounting on manifold strip	P-strip
Mounting screw tightening torque	2.5 Nm
Tightening torque tolerance	±0,2 mT
Weight	0.278 kg

Technical data

Part No.		MO		Compressed air connection	
				Input	
R422102235			NC/NC		1/4 - 18 NPTF
R422102237			NC/NC		1/4 - 18 NPTF
R422102238			NC/NC		1/4 - 18 NPTF
R422102239			NO/NO		1/4 - 18 NPTF
R422102241			NO/NO		1/4 - 18 NPTF
R422102242			NO/NO		1/4 - 18 NPTF
R422102243			NC/NO		1/4 - 18 NPTF
R422102245			NC/NO		1/4 - 18 NPTF
R422102246			NC/NO		1/4 - 18 NPTF
R422102247			NC/NC		1/4 - 18 NPTF
R422102249			NC/NC		1/4 - 18 NPTF
R422102250			NC/NC		1/4 - 18 NPTF
R422102251			NC/NC		1/4 - 18 NPTF
R422102253			NC/NC		1/4 - 18 NPTF
R422102254			NC/NC		1/4 - 18 NPTF
R422102255			NC/NO		1/4 - 18 NPTF
R422102257			NC/NO		1/4 - 18 NPTF
R422102258			NC/NO		1/4 - 18 NPTF

Part No.	Compressed air connection	
	Output	Exhaust
R422102235	1/4 - 18 NPTF	1/4 - 18 NPTF
R422102237	1/4 - 18 NPTF	1/4 - 18 NPTF
R422102238	1/4 - 18 NPTF	1/4 - 18 NPTF
R422102239	1/4 - 18 NPTF	1/4 - 18 NPTF
R422102241	1/4 - 18 NPTF	1/4 - 18 NPTF
R422102242	1/4 - 18 NPTF	1/4 - 18 NPTF
R422102243	1/4 - 18 NPTF	1/4 - 18 NPTF
R422102245	1/4 - 18 NPTF	1/4 - 18 NPTF
R422102246	1/4 - 18 NPTF	1/4 - 18 NPTF
R422102247	1/4 - 18 NPTF	1/4 - 18 NPTF
R422102249	1/4 - 18 NPTF	1/4 - 18 NPTF
R422102250	1/4 - 18 NPTF	1/4 - 18 NPTF
R422102251	1/4 - 18 NPTF	1/4 - 18 NPTF
R422102253	1/4 - 18 NPTF	1/4 - 18 NPTF
R422102254	1/4 - 18 NPTF	1/4 - 18 NPTF
R422102255	1/4 - 18 NPTF	1/4 - 18 NPTF
R422102257	1/4 - 18 NPTF	1/4 - 18 NPTF
R422102258	1/4 - 18 NPTF	1/4 - 18 NPTF

Part No.	Compressed air connection		Operational voltage	Operational voltage
	Pilot Input			
R422102235	-		12 V	-
R422102237	-		-	110 V
R422102238	-		-	230 V

Part No.	Compressed air connection	Operational voltage	Operational voltage
	Pilot Input	DC	AC 50 Hz
R422102239	-	12 V	-
R422102241	-	-	110 V
R422102242	-	-	230 V
R422102243	-	12 V	-
R422102245	-	-	110 V
R422102246	-	-	230 V
R422102247	M5	12 V	-
R422102249	M5	-	110 V
R422102250	M5	-	230 V
R422102251	M5	12 V	-
R422102253	M5	-	110 V
R422102254	M5	-	230 V
R422102255	M5	12 V	-
R422102257	M5	-	110 V
R422102258	M5	-	230 V

Part No.	Operational voltage	Voltage tolerance	Voltage tolerance	Voltage tolerance
	AC 60 Hz	DC	AC 50 Hz	AC 60 Hz
R422102235	-	-10% / +15%	-	-
R422102237	110 V	-	-10% / +10%	-10% / +10%
R422102238	230 V	-	-10% / +10%	-10% / +10%
R422102239	-	-10% / +10%	-	-
R422102241	110 V	-	-10% / +10%	-10% / +10%
R422102242	230 V	-	-10% / +10%	-10% / +10%
R422102243	-	-10% / +10%	-	-
R422102245	110 V	-	-10% / +10%	-10% / +10%
R422102246	230 V	-	-10% / +10%	-10% / +10%
R422102247	-	-10% / +10%	-	-
R422102249	110 V	-	-10% / +10%	-10% / +10%
R422102250	230 V	-	-10% / +10%	-10% / +10%
R422102251	-	-10% / +10%	-	-
R422102253	110 V	-	-10% / +10%	-10% / +10%
R422102254	230 V	-	-10% / +10%	-10% / +10%
R422102255	-	-10% / +10%	-	-
R422102257	110 V	-	-10% / +10%	-10% / +10%
R422102258	230 V	-	-10% / +10%	-10% / +10%

Part No.	Power consumption	Holding power	Holding power	Switch-on power
	DC	AC 50 Hz	AC 60 Hz	AC 50 Hz
R422102235	2 W	-	-	-
R422102237	-	1.6 VA	1.4 VA	2.2 VA
R422102238	-	1.6 VA	1.4 VA	2.2 VA
R422102239	2 W	-	-	-
R422102241	-	1.6 VA	1.4 VA	2.2 VA
R422102242	-	1.6 VA	1.4 VA	2.2 VA
R422102243	2 W	-	-	-
R422102245	-	1.6 VA	1.4 VA	2.2 VA

Part No.	Power consumption	Holding power	Holding power	Switch-on power
	DC	AC 50 Hz	AC 60 Hz	AC 50 Hz
R422102246	-	1.6 VA	1.4 VA	2.2 VA
R422102247	2 W	-	-	-
R422102249	-	1.6 VA	1.4 VA	2.2 VA
R422102250	-	1.6 VA	1.4 VA	2.2 VA
R422102251	2 W	-	-	-
R422102253	-	1.6 VA	1.4 VA	2.2 VA
R422102254	-	1.6 VA	1.4 VA	2.2 VA
R422102255	2 W	-	-	-
R422102257	-	1.6 VA	1.4 VA	2.2 VA
R422102258	-	1.6 VA	1.4 VA	2.2 VA

Part No.	Switch-on power	Pilot	Flow conductance	Flow conductance	Nominal resistance
	AC 60 Hz		b	C-value	
R422102235	-	Internal	0.25	5.9 l/(s*bar)	185 Ω
R422102237	2 VA	Internal	0.25	5.9 l/(s*bar)	185 Ω
R422102238	2 VA	Internal	0.25	5.9 l/(s*bar)	185 Ω
R422102239	-	Internal	0.25	5.9 l/(s*bar)	185 Ω
R422102241	2 VA	Internal	0.25	5.9 l/(s*bar)	185 Ω
R422102242	2 VA	Internal	0.25	5.9 l/(s*bar)	185 Ω
R422102243	-	Internal	0.25	5.9 l/(s*bar)	185 Ω
R422102245	2 VA	Internal	0.25	5.9 l/(s*bar)	185 Ω
R422102246	2 VA	Internal	0.25	5.9 l/(s*bar)	185 Ω
R422102247	-	External	0.25	5.9 l/(s*bar)	185 Ω
R422102249	2 VA	External	0.25	5.9 l/(s*bar)	185 Ω
R422102250	2 VA	External	0.25	5.9 l/(s*bar)	185 Ω
R422102251	-	External	0.25	5.9 l/(s*bar)	185 Ω
R422102253	2 VA	External	0.25	5.9 l/(s*bar)	185 Ω
R422102254	2 VA	External	0.25	5.9 l/(s*bar)	185 Ω
R422102255	-	External	0.25	5.9 l/(s*bar)	185 Ω
R422102257	2 VA	External	0.25	5.9 l/(s*bar)	185 Ω
R422102258	2 VA	External	0.25	5.9 l/(s*bar)	185 Ω

Part No.	Working pressure min./max.
R422102235	3 ... 10 bar
R422102237	3 ... 10 bar
R422102238	3 ... 10 bar
R422102239	3 ... 10 bar
R422102241	3 ... 10 bar
R422102242	3 ... 10 bar
R422102243	3 ... 10 bar
R422102245	3 ... 10 bar
R422102246	3 ... 10 bar
R422102247	-0.95 ... 10 bar
R422102249	-0.95 ... 10 bar
R422102250	-0.95 ... 10 bar
R422102251	-0.95 ... 10 bar
R422102253	-0.95 ... 10 bar
R422102254	-0.95 ... 10 bar

Part No.	Working pressure min./max.
R422102255	-0.95 ... 10 bar
R422102257	-0.95 ... 10 bar
R422102258	-0.95 ... 10 bar

Nominal flow Qn at 6 bar and $\Delta p = 1$ bar, MO = Manual override

Technical information

The min. control pressure must be adhered to, since otherwise faulty switching and valve failure may result!

The pressure dew point must be at least 15 °C under ambient and medium temperature and may not exceed 3 °C .

The oil content of compressed air must remain constant during the life cycle.

Use only the approved oils from AVENTICS. Further information can be found in the "Technical information" document (available in the MediaCentre).

Technical information

Material	
Housing	Polyamide fiber-glass reinforced
Seals	Acrylonitrile butadiene rubber Hydrogenated nitrile butadiene rubber
Front plate	Polyamide fiber-glass reinforced
Threaded bushing	Brass Die cast zinc, nickel-plated chrome-plated

Dimensions

Dimensions in mm

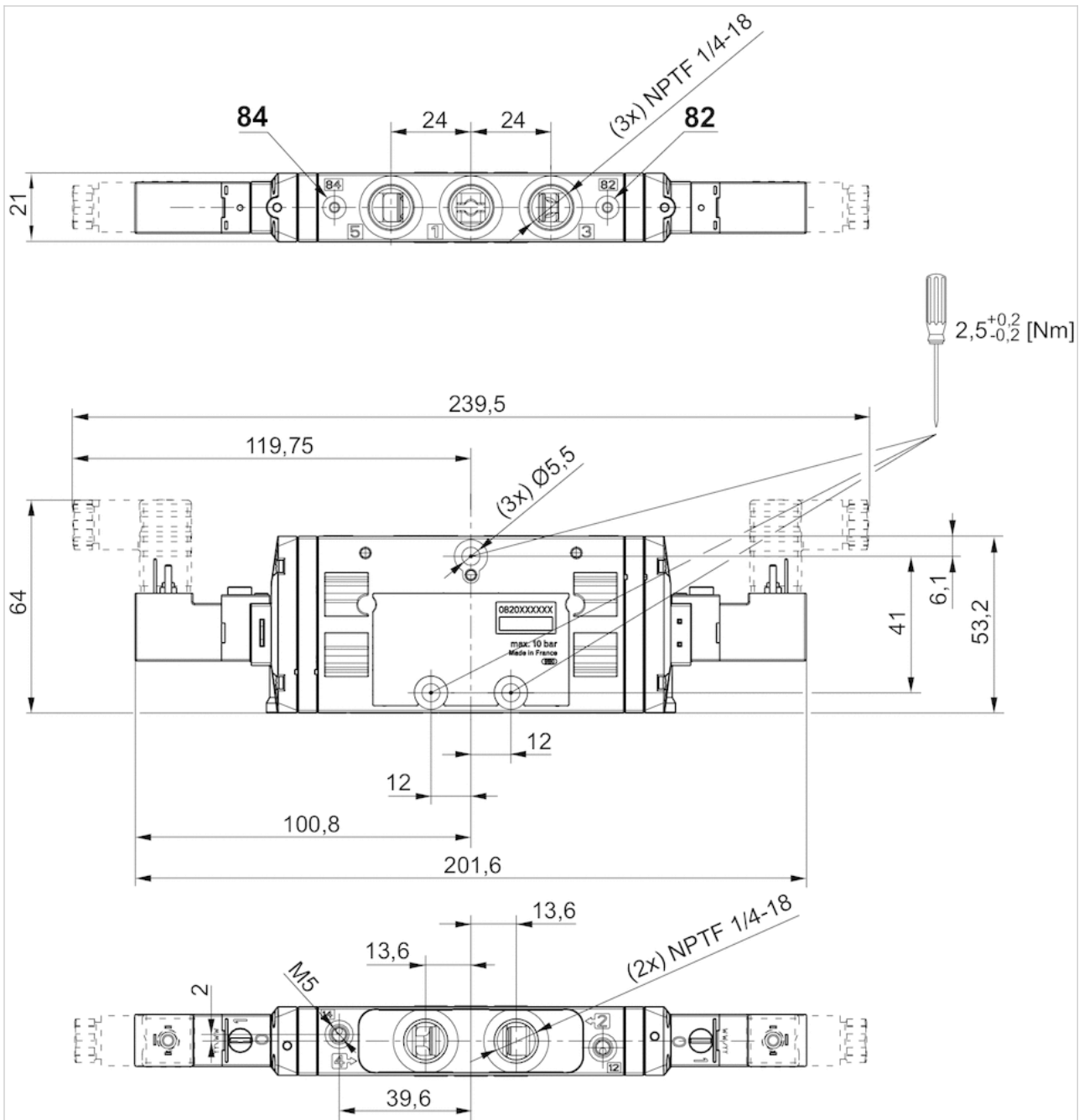

Dimensions in inches

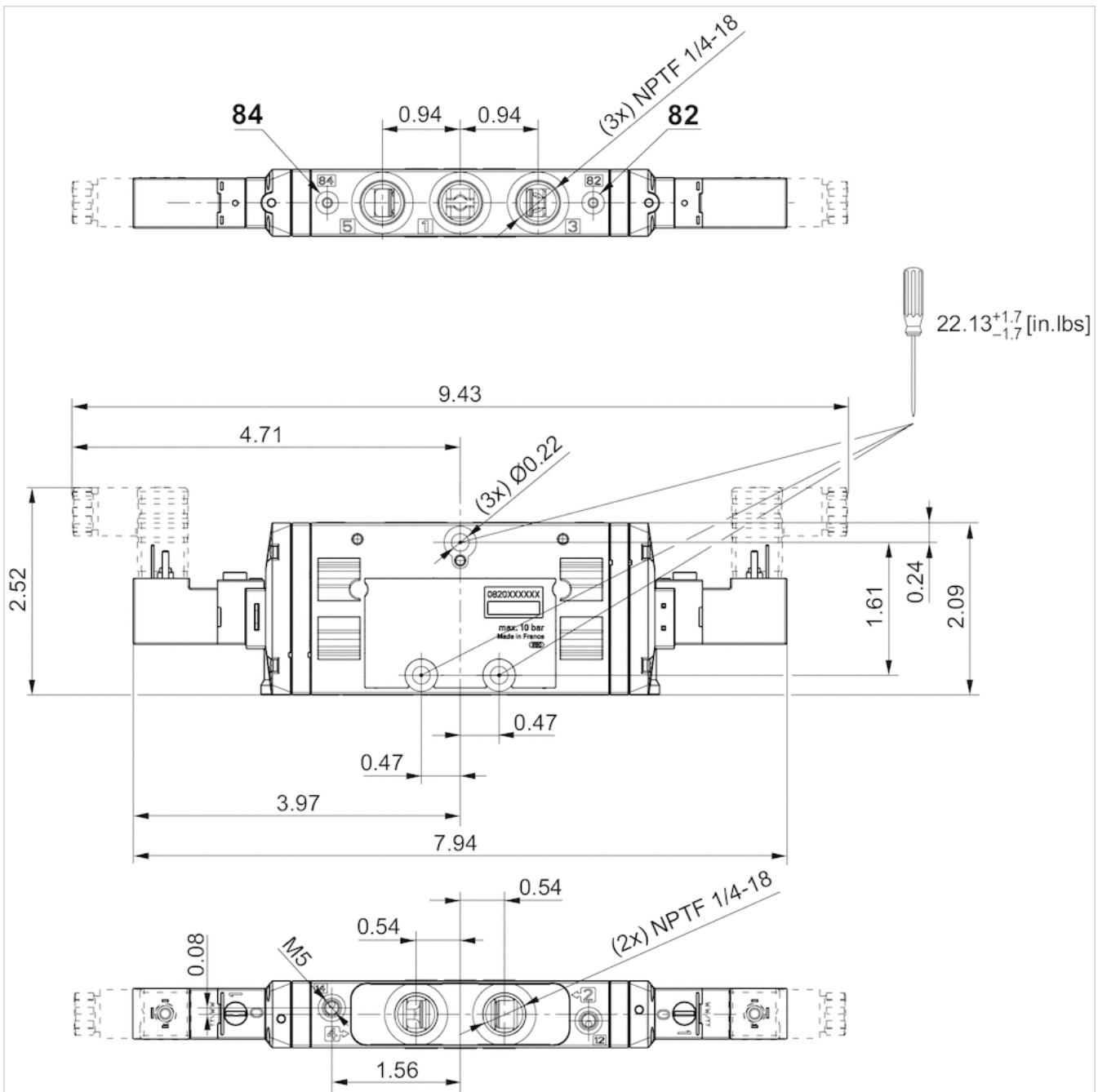





































5/2-directional valve, Series TC15 - inch

- Operating voltage 12 V AC, 110 V AC, 230 V AC
- 5/2
- $Q_n = 1500$ l/min
- Pilot valve width : 15 mm
- Pipe connection
- Compressed air connection output : 1/4 - 18 NPTF
- Electrical connection : Plug, ISO 15217, form C
- Manual override : with detent
- single solenoid
- With air spring return
- Pilot : Internal External



Version	Spool valve, positive overlapping
Activation	Electrically
Sealing principle	Soft sealing
Working pressure min./max.	See table below
Control pressure min./max.	See table below
Ambient temperature min./max.	-10 ... 50 °C
Medium temperature min./max.	-10 ... 50 °C
Medium	Compressed air
Max. particle size	5 µm
Oil content of compressed air	0 ... 5 mg/m ³
Nominal flow Q_n	1500 l/min
Compressed air connection	according to ANSI B1.20.3
Connector standard	ISO 15217
Protection class with connection	IP65
Duty cycle	100 %
Mounting on manifold strip	P-strip
Mounting screw tightening torque	2.5 Nm
Weight	See table below

Technical data

Part No.		MO	Compressed air connection	
			Input	Output
R422101248			1/4 - 18 NPTF	1/4 - 18 NPTF
R422101250			1/4 - 18 NPTF	1/4 - 18 NPTF
R422101251			1/4 - 18 NPTF	1/4 - 18 NPTF
R422101252			1/4 - 18 NPTF	1/4 - 18 NPTF
R422101254			1/4 - 18 NPTF	1/4 - 18 NPTF
R422101255			1/4 - 18 NPTF	1/4 - 18 NPTF
R422101256			1/4 - 18 NPTF	1/4 - 18 NPTF
R422101258			1/4 - 18 NPTF	1/4 - 18 NPTF
R422101259			1/4 - 18 NPTF	1/4 - 18 NPTF
R422101260			1/4 - 18 NPTF	1/4 - 18 NPTF
R422101262			1/4 - 18 NPTF	1/4 - 18 NPTF
R422101263			1/4 - 18 NPTF	1/4 - 18 NPTF
R422101264			1/4 - 18 NPTF	1/4 - 18 NPTF
R422101266			1/4 - 18 NPTF	1/4 - 18 NPTF
R422101267			1/4 - 18 NPTF	1/4 - 18 NPTF
R422101268			1/4 - 18 NPTF	1/4 - 18 NPTF
R422101270			1/4 - 18 NPTF	1/4 - 18 NPTF
R422101271			1/4 - 18 NPTF	1/4 - 18 NPTF

Part No.	Compressed air connection	Operational voltage	
		DC	AC 50 Hz
	Exhaust		
R422101248	1/4 - 18 NPTF	12 V	-
R422101250	1/4 - 18 NPTF	-	110 V
R422101251	1/4 - 18 NPTF	-	230 V
R422101252	1/4 - 18 NPTF	12 V	-
R422101254	1/4 - 18 NPTF	-	110 V
R422101255	1/4 - 18 NPTF	-	230 V
R422101256	1/4 - 18 NPTF	12 V	-
R422101258	1/4 - 18 NPTF	-	110 V
R422101259	1/4 - 18 NPTF	-	230 V
R422101260	1/4 - 18 NPTF	12 V	-
R422101262	1/4 - 18 NPTF	-	110 V
R422101263	1/4 - 18 NPTF	-	230 V
R422101264	1/4 - 18 NPTF	12 V	-
R422101266	1/4 - 18 NPTF	-	110 V
R422101267	1/4 - 18 NPTF	-	230 V
R422101268	1/4 - 18 NPTF	12 V	-
R422101270	1/4 - 18 NPTF	-	110 V
R422101271	1/4 - 18 NPTF	-	230 V

Part No.	Operational voltage	Voltage tolerance		
		DC	AC 50 Hz	AC 60 Hz
R422101248	-	-10% / +10%	-	-
R422101250	110 V	-	-10% / +10%	-10% / +10%
R422101251	230 V	-	-10% / +10%	-10% / +10%

Part No.	Operational voltage	Voltage tolerance	Voltage tolerance	Voltage tolerance
		AC 60 Hz	DC	AC 50 Hz
R422101252	-	-10% / +10%	-	-
R422101254	110 V	-	-10% / +10%	-10% / +10%
R422101255	230 V	-	-10% / +10%	-10% / +10%
R422101256	-	-10% / +10%	-	-
R422101258	110 V	-	-10% / +10%	-10% / +10%
R422101259	230 V	-	-10% / +10%	-10% / +10%
R422101260	-	-10% / +10%	-	-
R422101262	110 V	-	-10% / +10%	-10% / +10%
R422101263	230 V	-	-10% / +10%	-10% / +10%
R422101264	-	-10% / +10%	-	-
R422101266	110 V	-	-10% / +10%	-10% / +10%
R422101267	230 V	-	-10% / +10%	-10% / +10%
R422101268	-	-10% / +10%	-	-
R422101270	110 V	-	-10% / +10%	-10% / +10%
R422101271	230 V	-	-10% / +10%	-10% / +10%

Part No.	Power consumption	Holding power	Holding power	Switch-on power
	DC	AC 50 Hz	AC 60 Hz	AC 50 Hz
R422101248	2 W	-	-	-
R422101250	-	1.6 VA	1.4 VA	2.2 VA
R422101251	-	1.6 VA	1.4 VA	2.2 VA
R422101252	2 W	-	-	-
R422101254	-	1.6 VA	1.4 VA	2.2 VA
R422101255	-	1.6 VA	1.4 VA	2.2 VA
R422101256	2 W	-	-	-
R422101258	-	1.6 VA	1.4 VA	2.2 VA
R422101259	-	1.6 VA	1.4 VA	2.2 VA
R422101260	2 W	-	-	-
R422101262	-	1.6 VA	1.4 VA	2.2 VA
R422101263	-	1.6 VA	1.4 VA	2.2 VA
R422101264	2 W	-	-	-
R422101266	-	1.6 VA	1.4 VA	2.2 VA
R422101267	-	1.6 VA	1.4 VA	2.2 VA
R422101268	2 W	-	-	-
R422101270	-	1.6 VA	1.4 VA	2.2 VA
R422101271	-	1.6 VA	1.4 VA	2.2 VA

Part No.	Switch-on power	Pilot	Flow conductance	Flow conductance	Nominal resistance
	AC 60 Hz		b	C-value	
R422101248	-	Internal	0.33	6.8 l/(s*bar)	185 Ω
R422101250	2 VA	Internal	0.33	6.8 l/(s*bar)	185 Ω
R422101251	2 VA	Internal	0.33	6.8 l/(s*bar)	185 Ω
R422101252	-	External	0.33	6.8 l/(s*bar)	185 Ω
R422101254	2 VA	External	0.33	6.8 l/(s*bar)	185 Ω
R422101255	2 VA	External	0.33	6.8 l/(s*bar)	185 Ω
R422101256	-	Internal	0.33	6.8 l/(s*bar)	185 Ω
R422101258	2 VA	Internal	0.33	6.8 l/(s*bar)	185 Ω
R422101259	2 VA	Internal	0.33	6.8 l/(s*bar)	185 Ω

Part No.	Switch-on power	Pilot	Flow conductance	Flow conductance	Nominal resistance
	AC 60 Hz		b	C-value	
R422101260	-	External	0.33	6.8 l/(s*bar)	185 Ω
R422101262	2 VA	External	0.33	6.8 l/(s*bar)	185 Ω
R422101263	2 VA	External	0.33	6.8 l/(s*bar)	185 Ω
R422101264	-	Internal	0.33	6.8 l/(s*bar)	185 Ω
R422101266	2 VA	Internal	0.33	6.8 l/(s*bar)	185 Ω
R422101267	2 VA	Internal	0.33	6.8 l/(s*bar)	185 Ω
R422101268	-	External	0.33	6.8 l/(s*bar)	185 Ω
R422101270	2 VA	External	0.33	6.8 l/(s*bar)	185 Ω
R422101271	2 VA	External	0.33	6.8 l/(s*bar)	185 Ω

Part No.	Working pressure min./max.	Control pressure min./max.	Typ. switch-on time	Typ. switch-off time
R422101248	2.5 ... 10 bar	2.5 ... 10 bar	21 ms	22 ms
R422101250	2.5 ... 10 bar	2.5 ... 10 bar	21 ms	22 ms
R422101251	2.5 ... 10 bar	2.5 ... 10 bar	21 ms	22 ms
R422101252	-0.9 ... 10 bar	2.5 ... 10 bar	21 ms	22 ms
R422101254	-0.9 ... 10 bar	2.5 ... 10 bar	21 ms	22 ms
R422101255	-0.9 ... 10 bar	2.5 ... 10 bar	21 ms	22 ms
R422101256	3 ... 10 bar	3 ... 10 bar	12 ms	35 ms
R422101258	3 ... 10 bar	3 ... 10 bar	12 ms	35 ms
R422101259	3 ... 10 bar	3 ... 10 bar	12 ms	35 ms
R422101260	-0.9 ... 10 bar	3 ... 10 bar	12 ms	35 ms
R422101262	-0.9 ... 10 bar	3 ... 10 bar	12 ms	35 ms
R422101263	-0.9 ... 10 bar	3 ... 10 bar	12 ms	35 ms
R422101264	2 ... 10 bar	2 ... 10 bar	10 ms	10 ms
R422101266	2 ... 10 bar	2 ... 10 bar	10 ms	10 ms
R422101267	2 ... 10 bar	2 ... 10 bar	10 ms	10 ms
R422101268	-0.9 ... 10 bar	2 ... 10 bar	10 ms	10 ms
R422101270	-0.9 ... 10 bar	2 ... 10 bar	10 ms	10 ms
R422101271	-0.9 ... 10 bar	2 ... 10 bar	10 ms	10 ms

Part No.	Weight
R422101248	0.235 kg
R422101250	0.235 kg
R422101251	0.235 kg
R422101252	0.235 kg
R422101254	0.235 kg
R422101255	0.235 kg
R422101256	0.235 kg
R422101258	0.235 kg
R422101259	0.235 kg
R422101260	0.235 kg
R422101262	0.235 kg
R422101263	0.235 kg
R422101264	0.263 kg
R422101266	0.263 kg
R422101267	0.263 kg
R422101268	0.263 kg

Part No.	Weight
R422101270	0.263 kg
R422101271	0.263 kg

Nominal flow Qn at 6 bar and $\Delta p = 1$ bar, MO = Manual override

Technical information

The min. control pressure must be adhered to, since otherwise faulty switching and valve failure may result!

The pressure dew point must be at least 15 °C under ambient and medium temperature and may not exceed 3 °C .

The oil content of compressed air must remain constant during the life cycle.

Use only the approved oils from AVENTICS. Further information can be found in the "Technical information" document (available in the MediaCentre).

Technical information

Material	
Housing	Polyamide fiber-glass reinforced
Seals	Acrylonitrile butadiene rubber Hydrogenated nitrile butadiene rubber
Front plate	Polyamide fiber-glass reinforced
Threaded bushing	Brass Die cast zinc, nickel-plated chrome-plated

Dimensions

Dimensions in mm, single solenoid

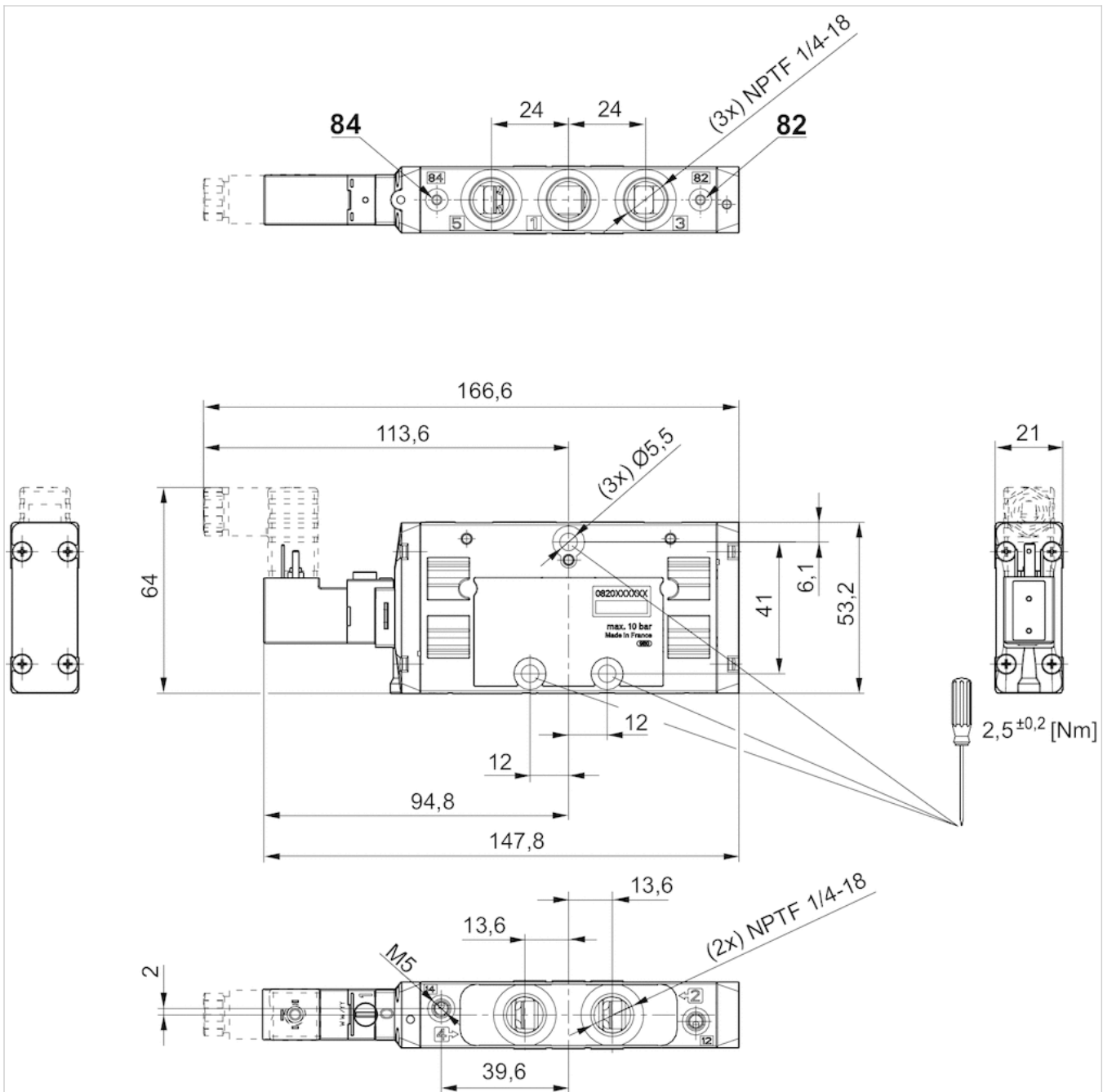

Dimensions in inches, single solenoid

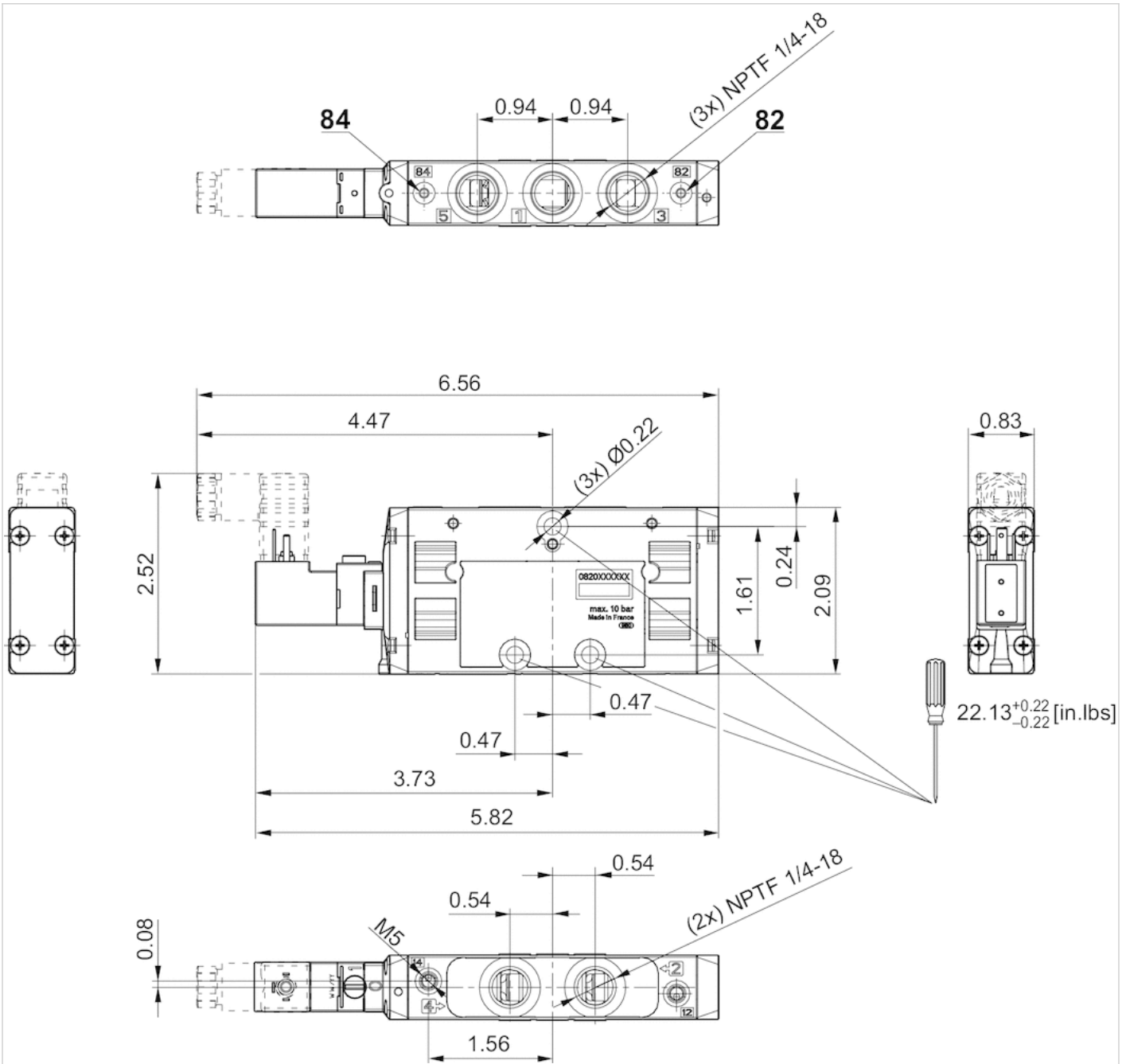

Dimensions in mm, double solenoid

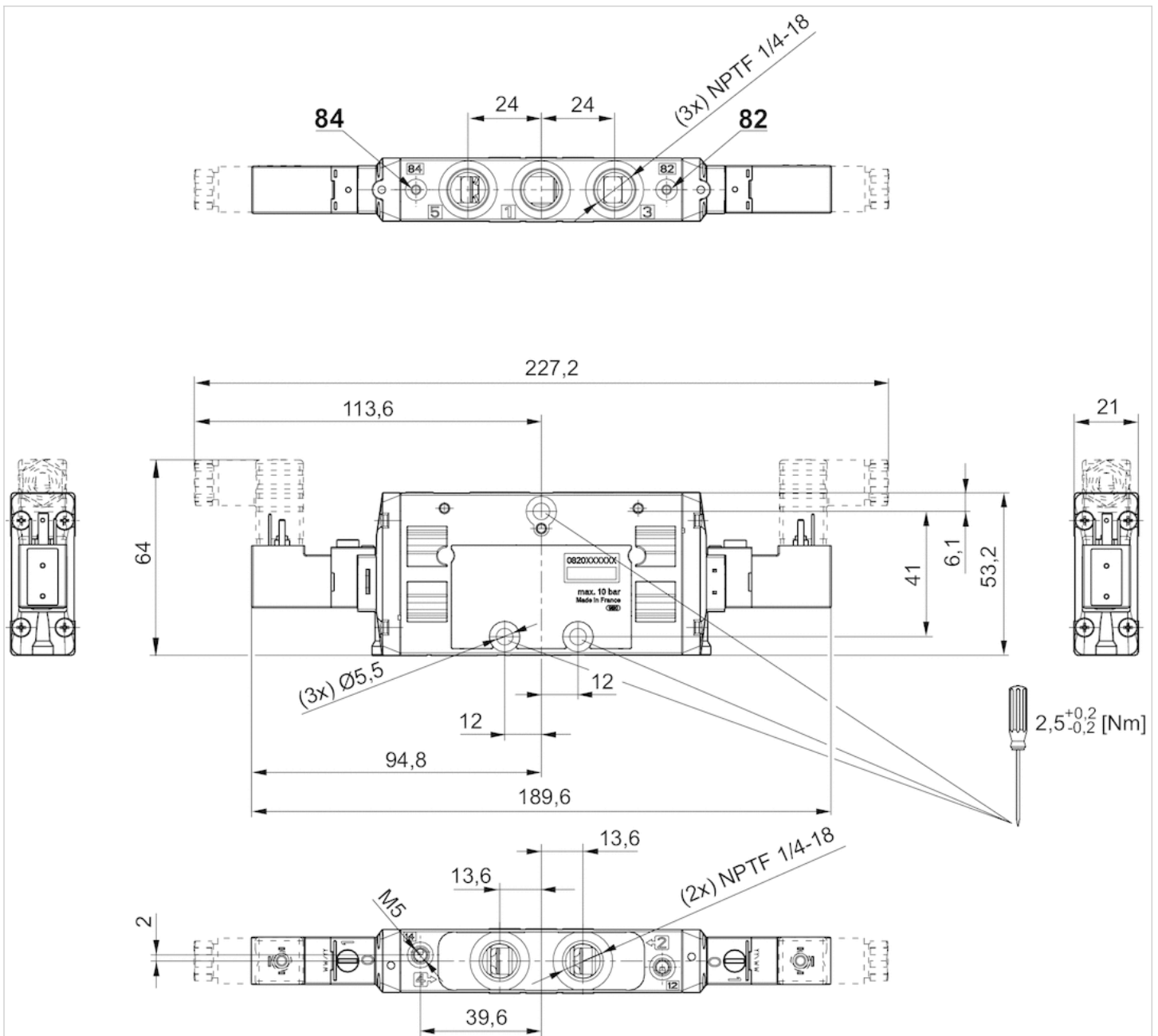

Dimensions in inches, double solenoid

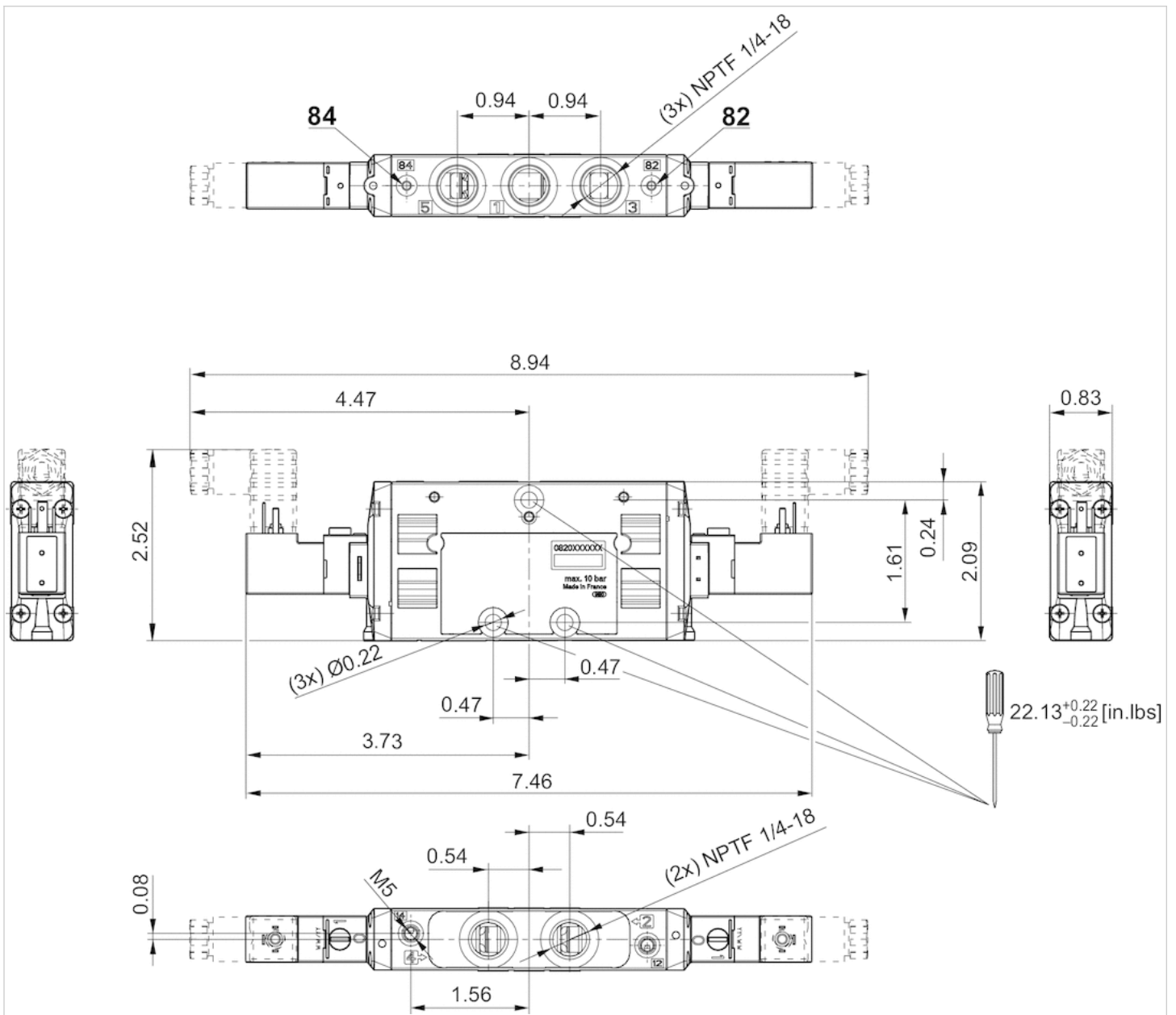

5/3-directional valve, Series TC15 - inch

- Operating voltage 12 V AC, 110 V AC, 230 V AC
- 5/3
- Qn = 1300 l/min
- Pilot valve width : 15 mm
- closed center exhausted center pressurized center
- Pipe connection
- Compressed air connection output : 1/4 - 18 NPTF
- Electrical connection : Plug, ISO 15217, form C
- Manual override : with detent
- double solenoid
- Pilot : Internal External



Version	Spool valve, positive overlapping
Activation	Electrically
Sealing principle	Soft sealing
Working pressure min./max.	See table below
Control pressure min./max.	3 ... 10 bar
Ambient temperature min./max.	-10 ... 50 °C
Medium temperature min./max.	-10 ... 50 °C
Medium	Compressed air
Max. particle size	5 µm
Oil content of compressed air	0 ... 5 mg/m ³
Nominal flow Qn	1300 l/min
Compressed air connection	according to ANSI B1.20.3
Connector standard	ISO 15217
Protection class with connection	IP65
Duty cycle	100 %
Typ. switch-on time	12 ms
Typ. switch-off time	13 ms
Mounting on manifold strip	P-strip
Mounting screw tightening torque	2.5 Nm
Weight	0.309 kg

Technical data

Part No.		MO	Compressed air connection	
				Input
R422101272			closed center	1/4 - 18 NPTF
R422101274			closed center	1/4 - 18 NPTF
R422101275			closed center	1/4 - 18 NPTF
R422101276			closed center	1/4 - 18 NPTF
R422101278			closed center	1/4 - 18 NPTF
R422101279			closed center	1/4 - 18 NPTF
R422101280			exhausted center	1/4 - 18 NPTF
R422101282			exhausted center	1/4 - 18 NPTF
R422101283			exhausted center	1/4 - 18 NPTF
R422101284			exhausted center	1/4 - 18 NPTF
R422101286			exhausted center	1/4 - 18 NPTF
R422101287			exhausted center	1/4 - 18 NPTF
R422101288			pressurized center	1/4 - 18 NPTF
R422101290			pressurized center	1/4 - 18 NPTF
R422101291			pressurized center	1/4 - 18 NPTF
R422101292			pressurized center	1/4 - 18 NPTF
R422101294			pressurized center	1/4 - 18 NPTF
R422101295			pressurized center	1/4 - 18 NPTF

Part No.	Compressed air connection	
	Output	Exhaust
R422101272	1/4 - 18 NPTF	1/4 - 18 NPTF
R422101274	1/4 - 18 NPTF	1/4 - 18 NPTF
R422101275	1/4 - 18 NPTF	1/4 - 18 NPTF
R422101276	1/4 - 18 NPTF	1/4 - 18 NPTF
R422101278	1/4 - 18 NPTF	1/4 - 18 NPTF
R422101279	1/4 - 18 NPTF	1/4 - 18 NPTF
R422101280	1/4 - 18 NPTF	1/4 - 18 NPTF
R422101282	1/4 - 18 NPTF	1/4 - 18 NPTF
R422101283	1/4 - 18 NPTF	1/4 - 18 NPTF
R422101284	1/4 - 18 NPTF	1/4 - 18 NPTF
R422101286	1/4 - 18 NPTF	1/4 - 18 NPTF
R422101287	1/4 - 18 NPTF	1/4 - 18 NPTF
R422101288	1/4 - 18 NPTF	1/4 - 18 NPTF
R422101290	1/4 - 18 NPTF	1/4 - 18 NPTF
R422101291	1/4 - 18 NPTF	1/4 - 18 NPTF
R422101292	1/4 - 18 NPTF	1/4 - 18 NPTF
R422101294	1/4 - 18 NPTF	1/4 - 18 NPTF
R422101295	1/4 - 18 NPTF	1/4 - 18 NPTF

Part No.	Operational voltage		Operational voltage
	DC	AC 50 Hz	AC 60 Hz
R422101272	12 V	-	-
R422101274	-	110 V	110 V
R422101275	-	230 V	230 V

Part No.	Operational voltage	Operational voltage	Operational voltage
	DC	AC 50 Hz	AC 60 Hz
R422101276	12 V	-	-
R422101278	-	110 V	110 V
R422101279	-	230 V	230 V
R422101280	12 V	-	-
R422101282	-	110 V	110 V
R422101283	-	230 V	230 V
R422101284	12 V	-	-
R422101286	-	110 V	110 V
R422101287	-	230 V	230 V
R422101288	12 V	-	-
R422101290	-	110 V	110 V
R422101291	-	230 V	230 V
R422101292	12 V	-	-
R422101294	-	110 V	110 V
R422101295	-	230 V	230 V

Part No.	Voltage tolerance	Voltage tolerance	Voltage tolerance	Power consumption
	DC	AC 50 Hz	AC 60 Hz	DC
R422101272	-10% / +10%	-	-	2 W
R422101274	-	-10% / +10%	-10% / +10%	-
R422101275	-	-10% / +10%	-10% / +10%	-
R422101276	-10% / +10%	-	-	2 W
R422101278	-	-10% / +10%	-10% / +10%	-
R422101279	-	-10% / +10%	-10% / +10%	-
R422101280	-10% / +10%	-	-	2 W
R422101282	-	-10% / +10%	-10% / +10%	-
R422101283	-	-10% / +10%	-10% / +10%	-
R422101284	-10% / +10%	-	-	2 W
R422101286	-	-10% / +10%	-10% / +10%	-
R422101287	-	-10% / +10%	-10% / +10%	-
R422101288	-10% / +10%	-	-	2 W
R422101290	-	-10% / +10%	-10% / +10%	-
R422101291	-	-10% / +10%	-10% / +10%	-
R422101292	-10% / +10%	-	-	2 W
R422101294	-	-10% / +10%	-10% / +10%	-
R422101295	-	-10% / +10%	-10% / +10%	-

Part No.	Holding power	Holding power	Switch-on power	Switch-on power	Pilot
	AC 50 Hz	AC 60 Hz	AC 50 Hz	AC 60 Hz	
R422101272	-	-	-	-	Internal
R422101274	3 VA	2.4 VA	4 VA	3.8 VA	Internal
R422101275	3 VA	2.4 VA	4 VA	3.8 VA	Internal
R422101276	-	-	-	-	External
R422101278	3 VA	2.4 VA	4 VA	3.8 VA	External
R422101279	3 VA	2.4 VA	4 VA	3.8 VA	External
R422101280	-	-	-	-	Internal
R422101282	3 VA	2.4 VA	4 VA	3.8 VA	Internal
R422101283	3 VA	2.4 VA	4 VA	3.8 VA	Internal

Part No.	Holding power	Holding power	Switch-on power	Switch-on power	Pilot
	AC 50 Hz	AC 60 Hz	AC 50 Hz	AC 60 Hz	
R422101284	-	-	-	-	External
R422101286	3 VA	2.4 VA	4 VA	3.8 VA	External
R422101287	3 VA	2.4 VA	4 VA	3.8 VA	External
R422101288	-	-	-	-	Internal
R422101290	3 VA	2.4 VA	4 VA	3.8 VA	Internal
R422101291	3 VA	2.4 VA	4 VA	3.8 VA	Internal
R422101292	-	-	-	-	External
R422101294	3 VA	2.4 VA	4 VA	3.8 VA	External
R422101295	3 VA	2.4 VA	4 VA	3.8 VA	External

Part No.	Flow conductance	Flow conductance	Nominal resistance	Working pressure min./max.
	b	C-value		
R422101272	0.31	5.9 l/(s*bar)	185 Ω	3 ... 10 bar
R422101274	0.31	5.9 l/(s*bar)	185 Ω	3 ... 10 bar
R422101275	0.31	5.9 l/(s*bar)	185 Ω	3 ... 10 bar
R422101276	0.31	5.9 l/(s*bar)	185 Ω	-0.9 ... 10 bar
R422101278	0.31	5.9 l/(s*bar)	185 Ω	-0.9 ... 10 bar
R422101279	0.31	5.9 l/(s*bar)	185 Ω	-0.9 ... 10 bar
R422101280	0.31	5.9 l/(s*bar)	185 Ω	3 ... 10 bar
R422101282	0.31	5.9 l/(s*bar)	185 Ω	3 ... 10 bar
R422101283	0.31	5.9 l/(s*bar)	185 Ω	3 ... 10 bar
R422101284	0.31	5.9 l/(s*bar)	185 Ω	-0.9 ... 10 bar
R422101286	0.31	5.9 l/(s*bar)	185 Ω	-0.9 ... 10 bar
R422101287	0.31	5.9 l/(s*bar)	185 Ω	-0.9 ... 10 bar
R422101288	0.31	5.9 l/(s*bar)	185 Ω	3 ... 10 bar
R422101290	0.31	5.9 l/(s*bar)	185 Ω	3 ... 10 bar
R422101291	0.31	5.9 l/(s*bar)	185 Ω	3 ... 10 bar
R422101292	0.31	5.9 l/(s*bar)	185 Ω	-0.9 ... 10 bar
R422101294	0.31	5.9 l/(s*bar)	185 Ω	-0.9 ... 10 bar
R422101295	0.31	5.9 l/(s*bar)	185 Ω	-0.9 ... 10 bar

Nominal flow Q_n at 6 bar and $\Delta p = 1$ bar, MO = Manual override

Technical information

The min. control pressure must be adhered to, since otherwise faulty switching and valve failure may result!

The pressure dew point must be at least 15 °C under ambient and medium temperature and may not exceed 3 °C .

The oil content of compressed air must remain constant during the life cycle.

Use only the approved oils from AVENTICS. Further information can be found in the "Technical information" document (available in the MediaCentre).

Technical information

Material	
Housing	Polyamide fiber-glass reinforced
Seals	Acrylonitrile butadiene rubber Hydrogenated nitrile butadiene rubber
Front plate	Polyamide fiber-glass reinforced

Material	
Threaded bushing	Brass Die cast zinc, nickel-plated chrome-plated

Dimensions

Dimensions in mm

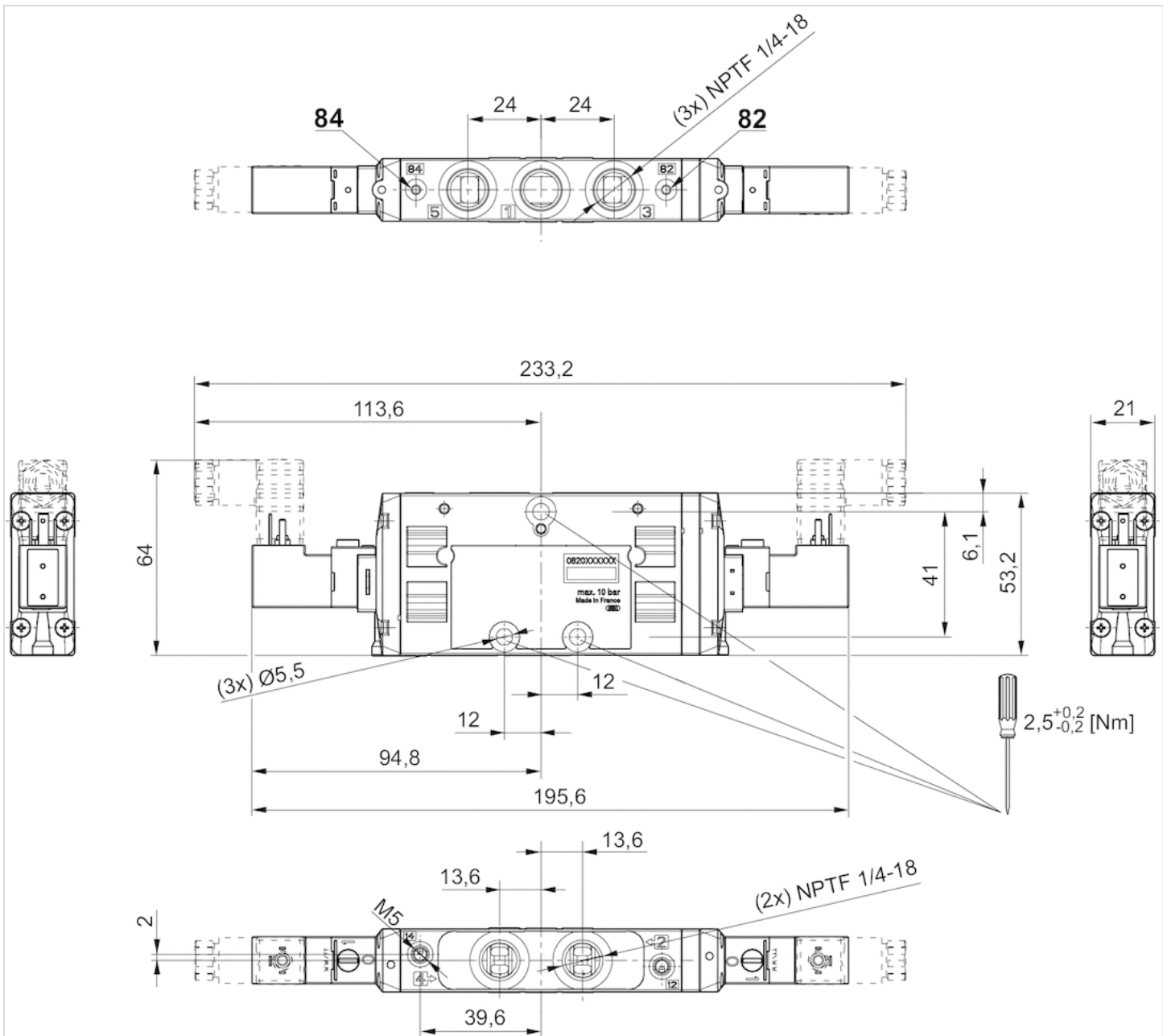

Dimensions in inches

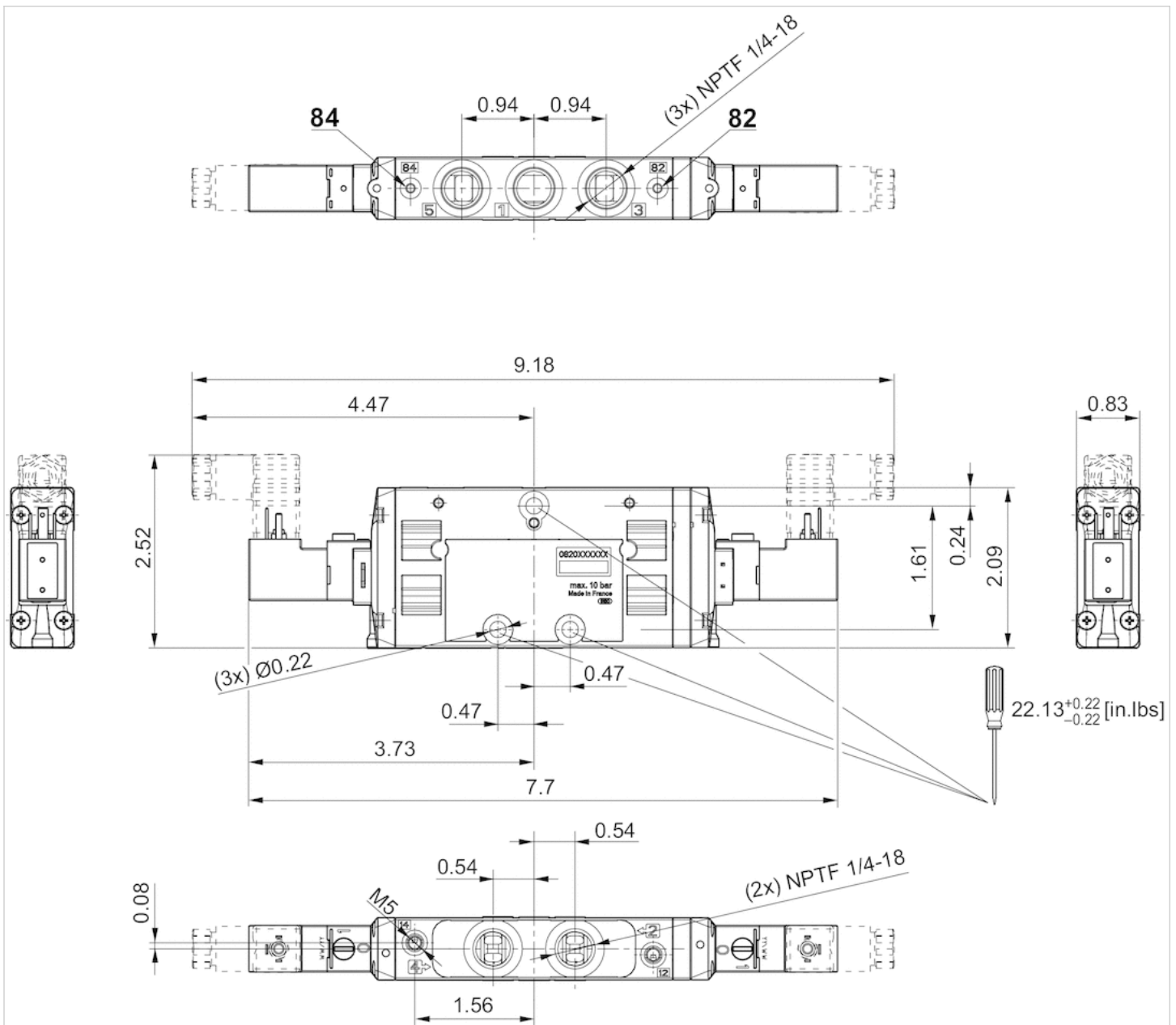













2x3/2-directional valve, Series TC15 - inch

- Operating voltage 24 V DC
- 2x3/2
- Qn = 1100 l/min
- Pilot valve width : 15 mm
- NC/NC NO/NO NC/NO
- Pipe connection
- Compressed air connection output : 1/4 - 18 NPTF
- Electrical connection : Plug, ISO 15217, form C
- Manual override : with detent
- double solenoid
- With spring return
- Pilot : Internal External



Version	Spool valve, positive overlapping
Activation	Electrically
Sealing principle	Soft sealing
Working pressure min./max.	See table below
Control pressure min./max.	3 ... 10 bar
Ambient temperature min./max.	-10 ... 50 °C
Medium temperature min./max.	-10 ... 50 °C
Medium	Compressed air
Max. particle size	5 µm
Oil content of compressed air	0 ... 5 mg/m ³
Nominal flow Qn	1100 l/min
Compressed air connection	according to ANSI B1.20.3
Connector standard	ISO 15217
Protection class with connection	IP65
Duty cycle	100 %
Typ. switch-on time	12 ms
Typ. switch-off time	16 ms
Generic emission standard in accordance with	EN 50081-2:1993
Mounting on manifold strip	P-strip
Mounting screw tightening torque	2.5 Nm
Tightening torque tolerance	±0,2 mT
Weight	0.278 kg

Technical data

Part No.		MO		Compressed air connection	
				Input	
R422102236			NC/NC		1/4 - 18 NPTF
R422102240			NO/NO		1/4 - 18 NPTF
R422102244			NC/NO		1/4 - 18 NPTF
R422102248			NC/NC		1/4 - 18 NPTF
R422102252			NC/NC		1/4 - 18 NPTF
R422102256			NC/NO		1/4 - 18 NPTF

Part No.	Compressed air connection	
	Output	Exhaust
R422102236	1/4 - 18 NPTF	1/4 - 18 NPTF
R422102240	1/4 - 18 NPTF	1/4 - 18 NPTF
R422102244	1/4 - 18 NPTF	1/4 - 18 NPTF
R422102248	1/4 - 18 NPTF	1/4 - 18 NPTF
R422102252	1/4 - 18 NPTF	1/4 - 18 NPTF
R422102256	1/4 - 18 NPTF	1/4 - 18 NPTF

Part No.	Compressed air connection		Operational voltage	Voltage tolerance
	Pilot Input			
R422102236	-		24 V	-10% / +10%
R422102240	-		24 V	-10% / +10%
R422102244	-		24 V	-10% / +10%
R422102248	M5		24 V	-10% / +10%
R422102252	M5		24 V	-10% / +10%
R422102256	M5		24 V	-10% / +10%

Part No.	Power consumption	Pilot	Flow conductance	Flow conductance	Nominal resistance
	DC		b	C-value	
R422102236	2 W	Internal	0.25	5.9 l/(s*bar)	185 Ω
R422102240	2 W	Internal	0.25	5.9 l/(s*bar)	185 Ω
R422102244	2 W	Internal	0.25	5.9 l/(s*bar)	185 Ω
R422102248	2 W	External	0.25	5.9 l/(s*bar)	185 Ω
R422102252	2 W	External	0.25	5.9 l/(s*bar)	185 Ω
R422102256	2 W	External	0.25	5.9 l/(s*bar)	185 Ω

Part No.	Working pressure min./max.
R422102236	3 ... 10 bar
R422102240	3 ... 10 bar
R422102244	3 ... 10 bar
R422102248	-0.95 ... 10 bar
R422102252	-0.95 ... 10 bar
R422102256	-0.95 ... 10 bar

Nominal flow Q_n at 6 bar and Δp = 1 bar, MO = Manual override

Technical information

The min. control pressure must be adhered to, since otherwise faulty switching and valve failure may result!

The pressure dew point must be at least 15 °C under ambient and medium temperature and may not exceed 3 °C .

The oil content of compressed air must remain constant during the life cycle.

Use only the approved oils from AVENTICS. Further information can be found in the "Technical information" document (available in the MediaCentre).

Technical information

Material	
Housing	Polyamide fiber-glass reinforced
Seals	Acrylonitrile butadiene rubber Hydrogenated nitrile butadiene rubber
Front plate	Polyamide fiber-glass reinforced
Threaded bushing	Brass Die cast zinc, nickel-plated chrome-plated

Dimensions

Dimensions in mm

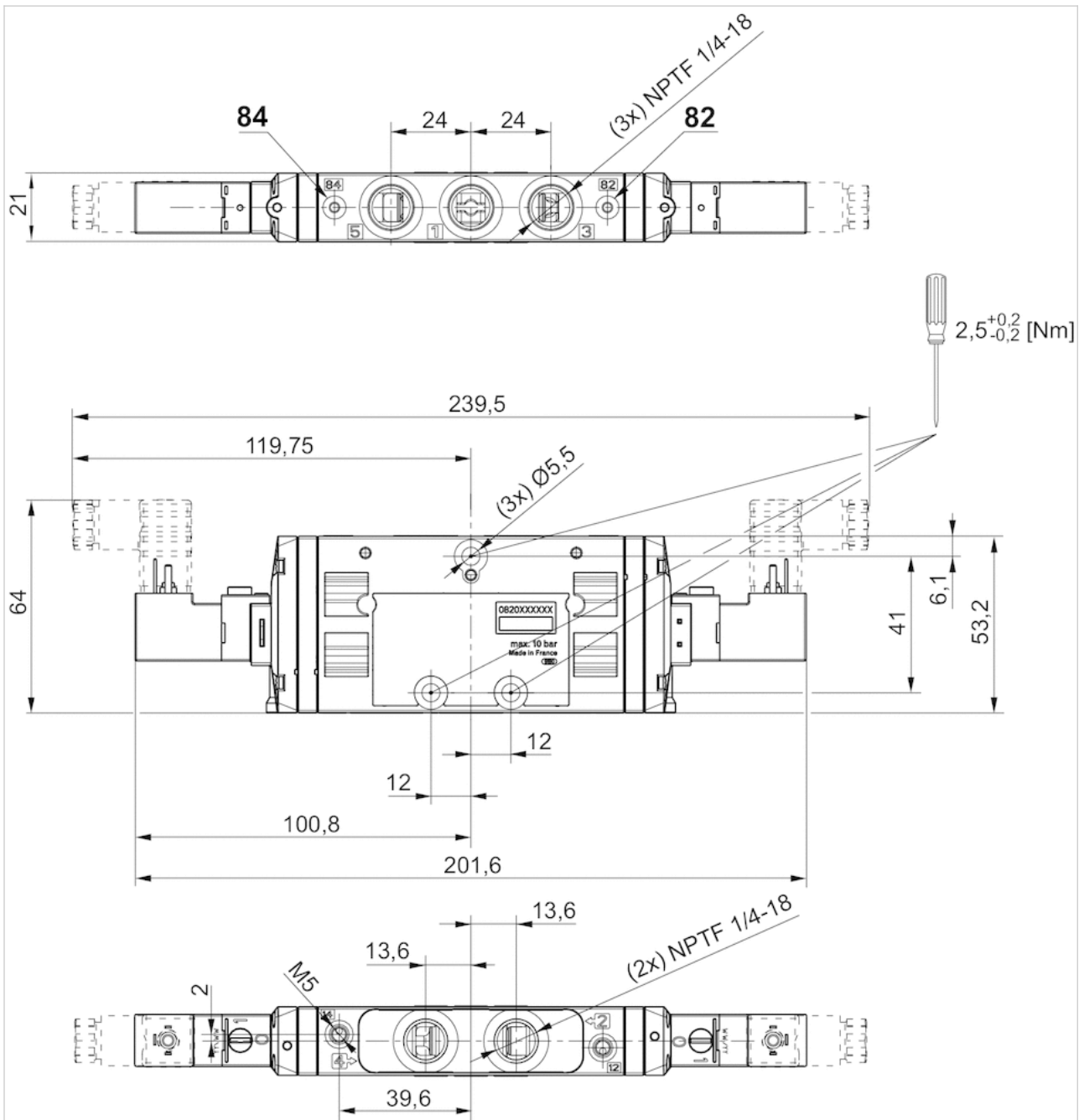

Dimensions in inches

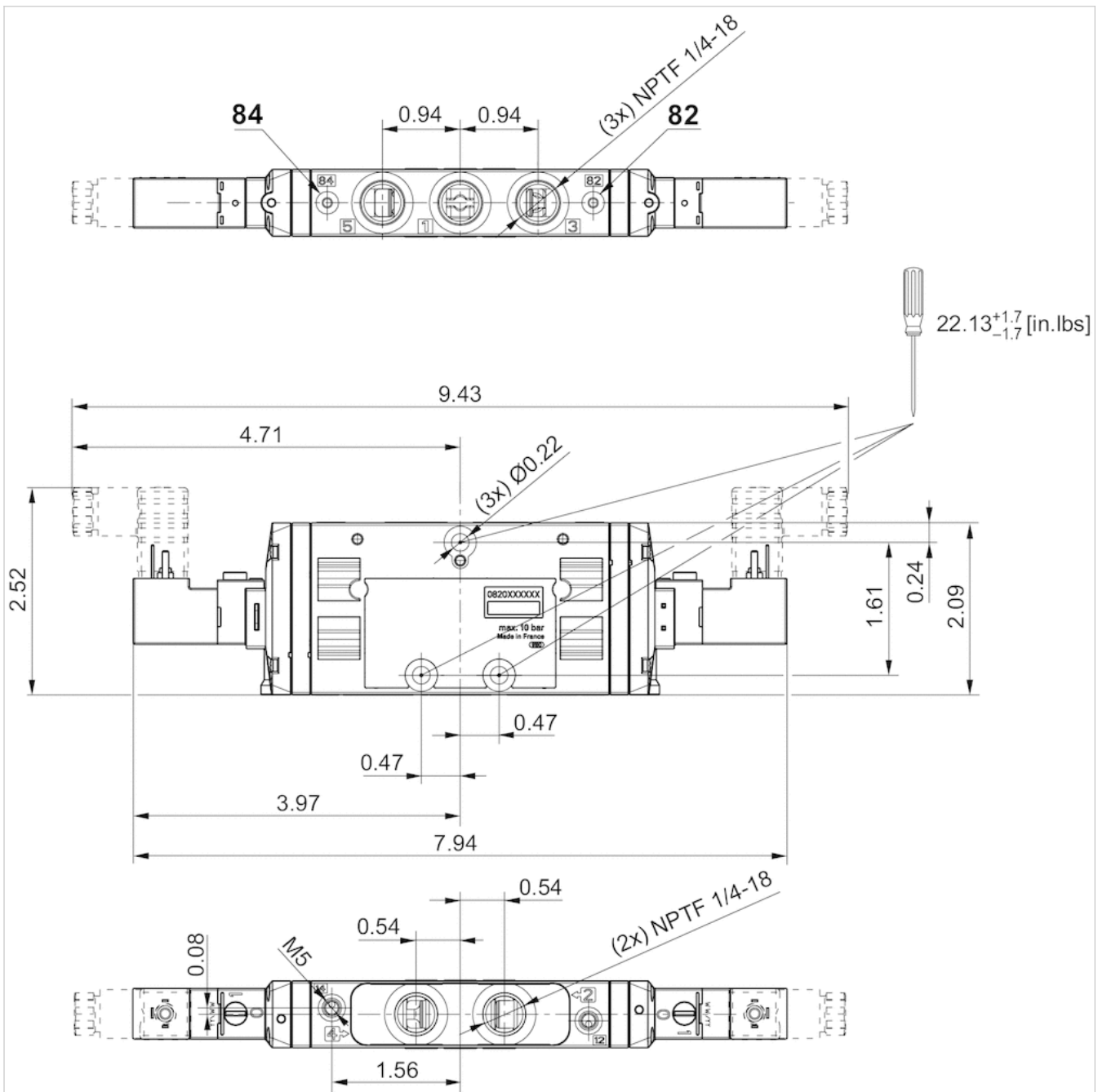





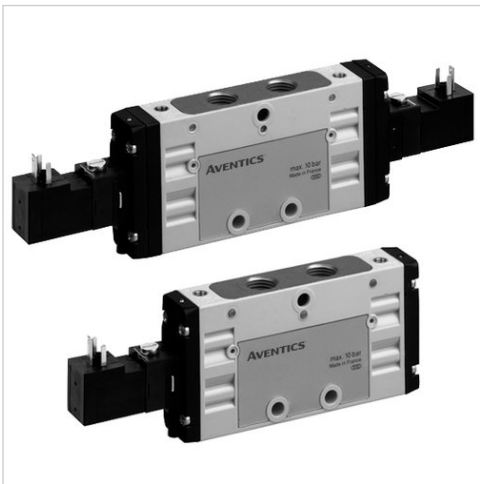





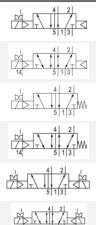
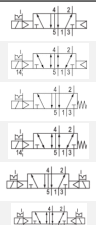

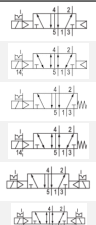
5/2-directional valve, Series TC15 - inch

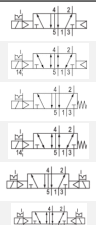
- Operating voltage 24 V DC
- 5/2
- Qn = 1500 l/min
- Pilot valve width : 15 mm
- Pipe connection
- Compressed air connection output : 1/4 - 18 NPTF
- Electrical connection : Plug, ISO 15217, form C
- Manual override : with detent
- single solenoid double solenoid
- With air spring return
- Pilot : Internal External

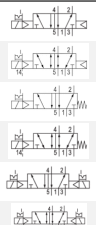

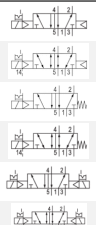
Version	Spool valve, positive overlapping
Activation	Electrically
Sealing principle	Soft sealing
Working pressure min./max.	See table below
Control pressure min./max.	See table below
Ambient temperature min./max.	-10 ... 50 °C
Medium temperature min./max.	-10 ... 50 °C
Medium	Compressed air
Max. particle size	5 µm
Oil content of compressed air	0 ... 5 mg/m ³
Nominal flow Qn	1500 l/min
Compressed air connection	according to ANSI B1.20.3
Connector standard	ISO 15217
Protection class with connection	IP65
Duty cycle	100 %
Mounting on manifold strip	P-strip
Mounting screw tightening torque	2.5 Nm
Weight	See table below
Comment	An example configuration is illustrated. The delivered product may thus deviate from the illustration.

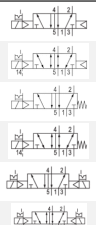
Technical data

Part No.		MO	Compressed air connection	Compressed air connection
			Input	Output
R422101249			1/4 - 18 NPTF	1/4 - 18 NPTF
R422101253			1/4 - 18 NPTF	1/4 - 18 NPTF
R422101257			1/4 - 18 NPTF	1/4 - 18 NPTF
R422101261			1/4 - 18 NPTF	1/4 - 18 NPTF
R422101265			1/4 - 18 NPTF	1/4 - 18 NPTF
R422101269			1/4 - 18 NPTF	1/4 - 18 NPTF

Part No.	Compressed air connection	Operational voltage	Voltage tolerance
	Exhaust	DC	DC
R422101249	1/4 - 18 NPTF	24 V	-10% / +10%
R422101253	1/4 - 18 NPTF	24 V	-10% / +10%
R422101257	1/4 - 18 NPTF	24 V	-10% / +10%
R422101261	1/4 - 18 NPTF	24 V	-10% / +10%
R422101265	1/4 - 18 NPTF	24 V	-10% / +10%
R422101269	1/4 - 18 NPTF	24 V	-10% / +10%

Part No.	Power consumption	Pilot	Flow conductance	Flow conductance	Nominal resistance
	DC		b	C-value	
R422101249	2 W	Internal	0.33	6.8 l/(s*bar)	185 Ω
R422101253	2 W	External	0.33	6.8 l/(s*bar)	185 Ω
R422101257	2 W	Internal	0.33	6.8 l/(s*bar)	185 Ω
R422101261	2 W	External	0.33	6.8 l/(s*bar)	185 Ω
R422101265	2 W	Internal	0.33	6.8 l/(s*bar)	185 Ω
R422101269	2 W	External	0.33	6.8 l/(s*bar)	185 Ω

Part No.	Working pressure min./max.	Control pressure min./max.	Typ. switch-on time	Typ. switch-off time
R422101249	2.5 ... 10 bar	2.5 ... 10 bar	21 ms	22 ms
R422101253	-0.9 ... 10 bar	2.5 ... 10 bar	21 ms	22 ms
R422101257	3 ... 10 bar	3 ... 10 bar	12 ms	35 ms
R422101261	-0.9 ... 10 bar	3 ... 10 bar	12 ms	35 ms
R422101265	2 ... 10 bar	2 ... 10 bar	10 ms	10 ms
R422101269	-0.9 ... 10 bar	2 ... 10 bar	10 ms	10 ms

Part No.	Weight
R422101249	0.235 kg
R422101253	0.235 kg
R422101257	0.235 kg
R422101261	0.235 kg
R422101265	0.263 kg
R422101269	0.263 kg

Nominal flow Q_n at 6 bar and $\Delta p = 1$ bar, MO = Manual override

Technical information

The min. control pressure must be adhered to, since otherwise faulty switching and valve failure may result!

The pressure dew point must be at least 15 °C under ambient and medium temperature and may not exceed 3 °C .

The oil content of compressed air must remain constant during the life cycle.

Use only the approved oils from AVENTICS. Further information can be found in the "Technical information" document (available in the MediaCentre).

Technical information

Material	
Housing	Polyamide fiber-glass reinforced
Seals	Acrylonitrile butadiene rubber Hydrogenated nitrile butadiene rubber
Front plate	Polyamide fiber-glass reinforced
Threaded bushing	Brass Die cast zinc, nickel-plated chrome-plated

Dimensions

Dimensions in mm, single solenoid

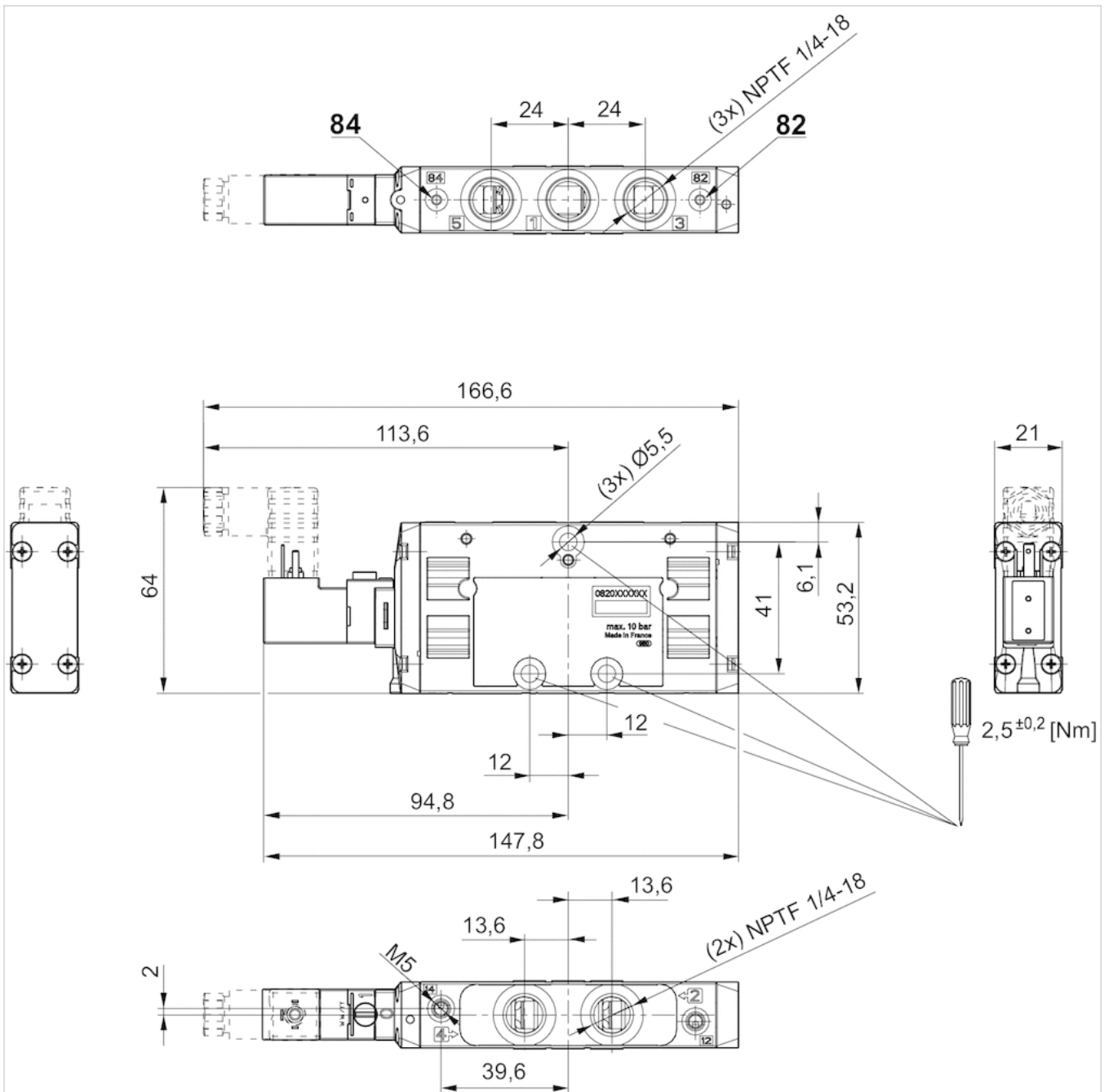

Dimensions in mm, double solenoid

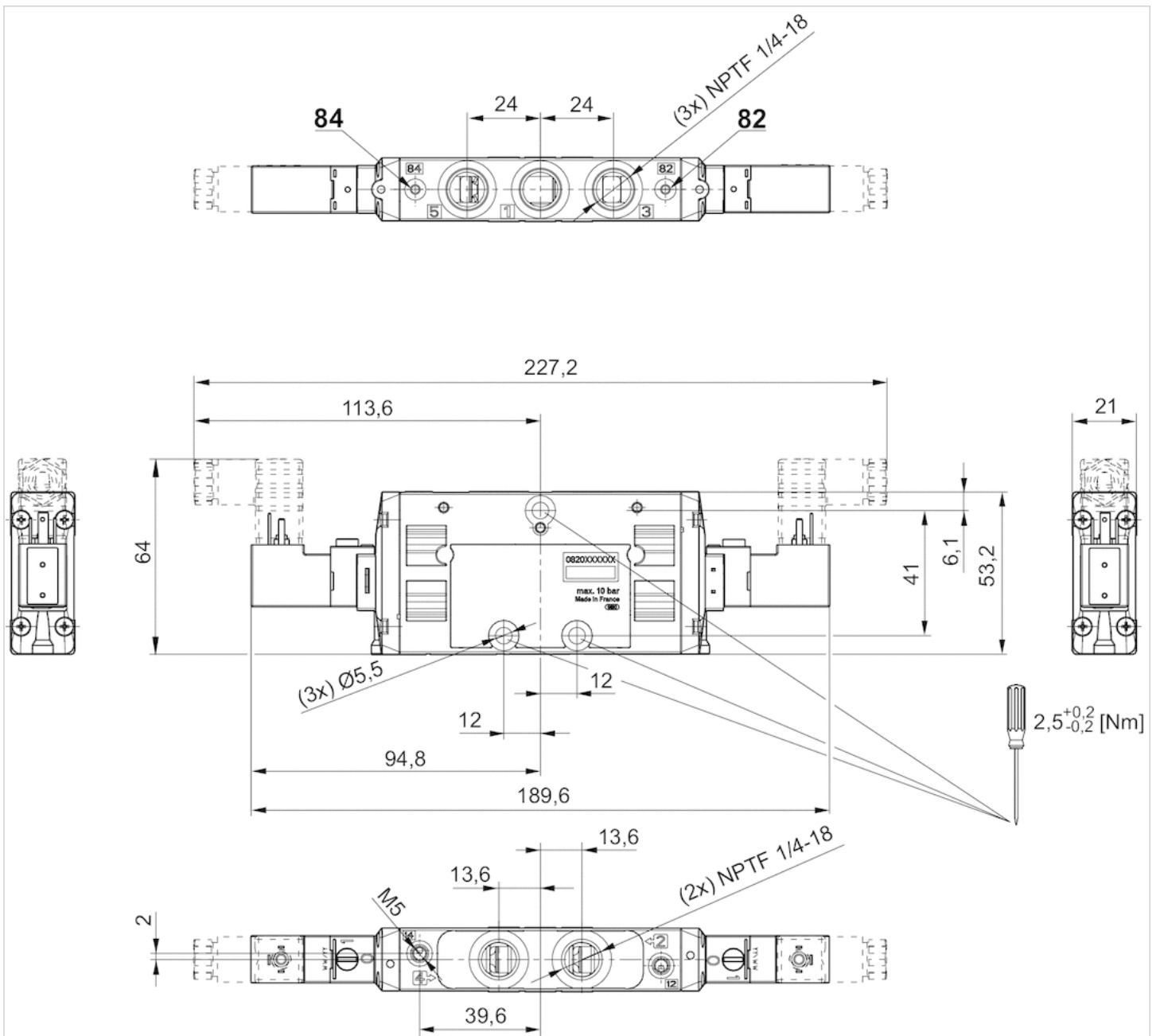

Dimensions in inches, double solenoid

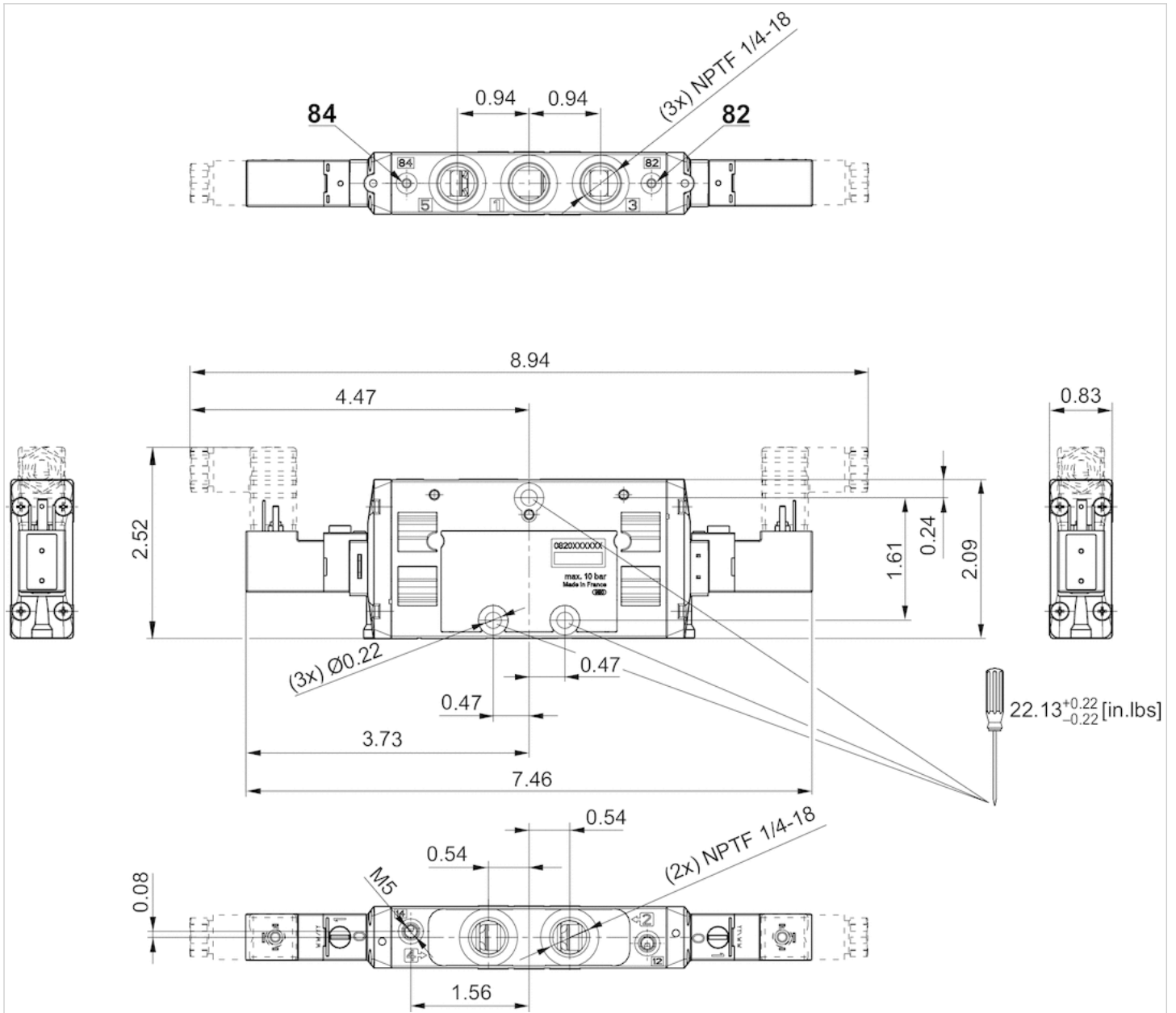











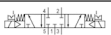

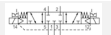
5/3-directional valve, Series TC15 - inch

- Operating voltage 24 V DC
- 5/3
- Qn = 1300 l/min
- Pilot valve width : 15 mm
- closed center exhausted center pressurized center
- Pipe connection
- Compressed air connection output : 1/4 - 18 NPTF
- Electrical connection : Plug, ISO 15217, form C
- Manual override : with detent
- double solenoid
- Pilot : Internal External

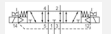

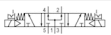
Version	Spool valve, positive overlapping
Activation	Electrically
Sealing principle	Soft sealing
Working pressure min./max.	See table below
Control pressure min./max.	3 ... 10 bar
Ambient temperature min./max.	-10 ... 50 °C
Medium temperature min./max.	-10 ... 50 °C
Medium	Compressed air
Max. particle size	5 µm
Oil content of compressed air	0 ... 5 mg/m ³
Nominal flow Qn	1300 l/min
Compressed air connection	according to ANSI B1.20.3
Connector standard	ISO 15217
Protection class with connection	IP65
Duty cycle	100 %
Typ. switch-on time	12 ms
Typ. switch-off time	13 ms
Mounting on manifold strip	P-strip
Mounting screw tightening torque	2.5 Nm
Weight	0.309 kg

Technical data

Part No.		MO	Compressed air connection	
				Input
R422101273			closed center	1/4 - 18 NPTF
R422101277			closed center	1/4 - 18 NPTF
R422101281			exhausted center	1/4 - 18 NPTF
R422101285			exhausted center	1/4 - 18 NPTF
R422101289			pressurized center	1/4 - 18 NPTF
R422101293			pressurized center	1/4 - 18 NPTF

Part No.	Compressed air connection	Compressed air connection
	Output	Exhaust
R422101273	1/4 - 18 NPTF	1/4 - 18 NPTF
R422101277	1/4 - 18 NPTF	1/4 - 18 NPTF
R422101281	1/4 - 18 NPTF	1/4 - 18 NPTF
R422101285	1/4 - 18 NPTF	1/4 - 18 NPTF
R422101289	1/4 - 18 NPTF	1/4 - 18 NPTF
R422101293	1/4 - 18 NPTF	1/4 - 18 NPTF

Part No.	Operational voltage	Voltage tolerance	Power consumption	Pilot
	DC	DC	DC	
R422101273	24 V	-10% / +10%	2 W	Internal
R422101277	24 V	-10% / +10%	2 W	External
R422101281	24 V	-10% / +10%	2 W	Internal
R422101285	24 V	-10% / +10%	2 W	External
R422101289	24 V	-10% / +10%	2 W	Internal
R422101293	24 V	-10% / +10%	2 W	External

Part No.	Flow conductance	Flow conductance	Nominal resistance	Working pressure min./max.
	b	C-value		
R422101273	0.31	5.9 l/(s*bar)	185 Ω	3 ... 10 bar
R422101277	0.31	5.9 l/(s*bar)	185 Ω	-0.9 ... 10 bar
R422101281	0.31	5.9 l/(s*bar)	185 Ω	3 ... 10 bar
R422101285	0.31	5.9 l/(s*bar)	185 Ω	-0.9 ... 10 bar
R422101289	0.31	5.9 l/(s*bar)	185 Ω	3 ... 10 bar
R422101293	0.31	5.9 l/(s*bar)	185 Ω	-0.9 ... 10 bar

Nominal flow Q_n at 6 bar and $\Delta p = 1$ bar, MO = Manual override

Technical information

The min. control pressure must be adhered to, since otherwise faulty switching and valve failure may result!

The pressure dew point must be at least 15 °C under ambient and medium temperature and may not exceed 3 °C .

The oil content of compressed air must remain constant during the life cycle.

Use only the approved oils from AVENTICS. Further information can be found in the "Technical information" document (available in the MediaCentre).

Technical information

Material	
Housing	Polyamide fiber-glass reinforced
Seals	Acrylonitrile butadiene rubber Hydrogenated nitrile butadiene rubber
Front plate	Polyamide fiber-glass reinforced
Threaded bushing	Brass Die cast zinc, nickel-plated chrome-plated

Dimensions

Dimensions in mm

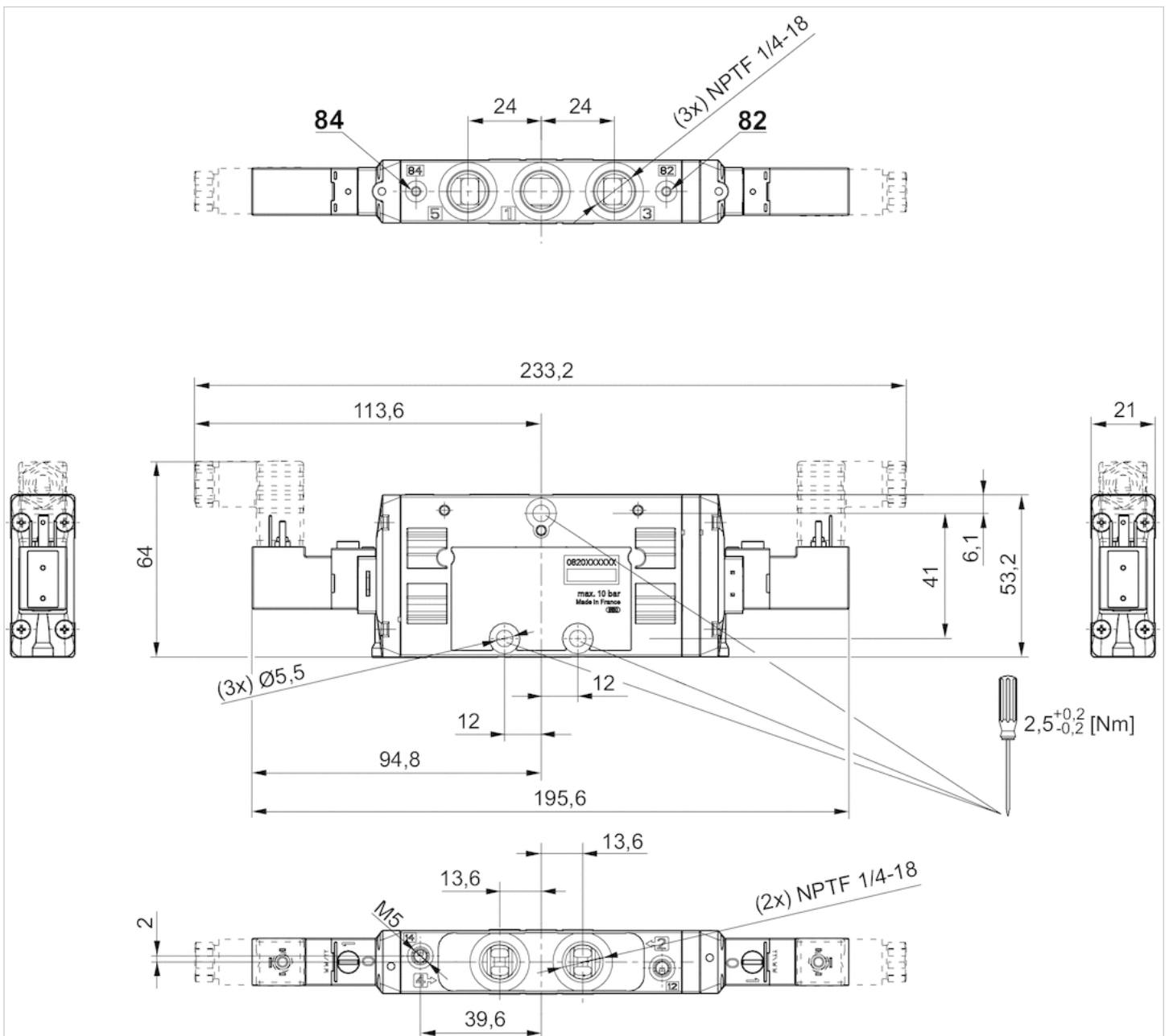

Dimensions in inches

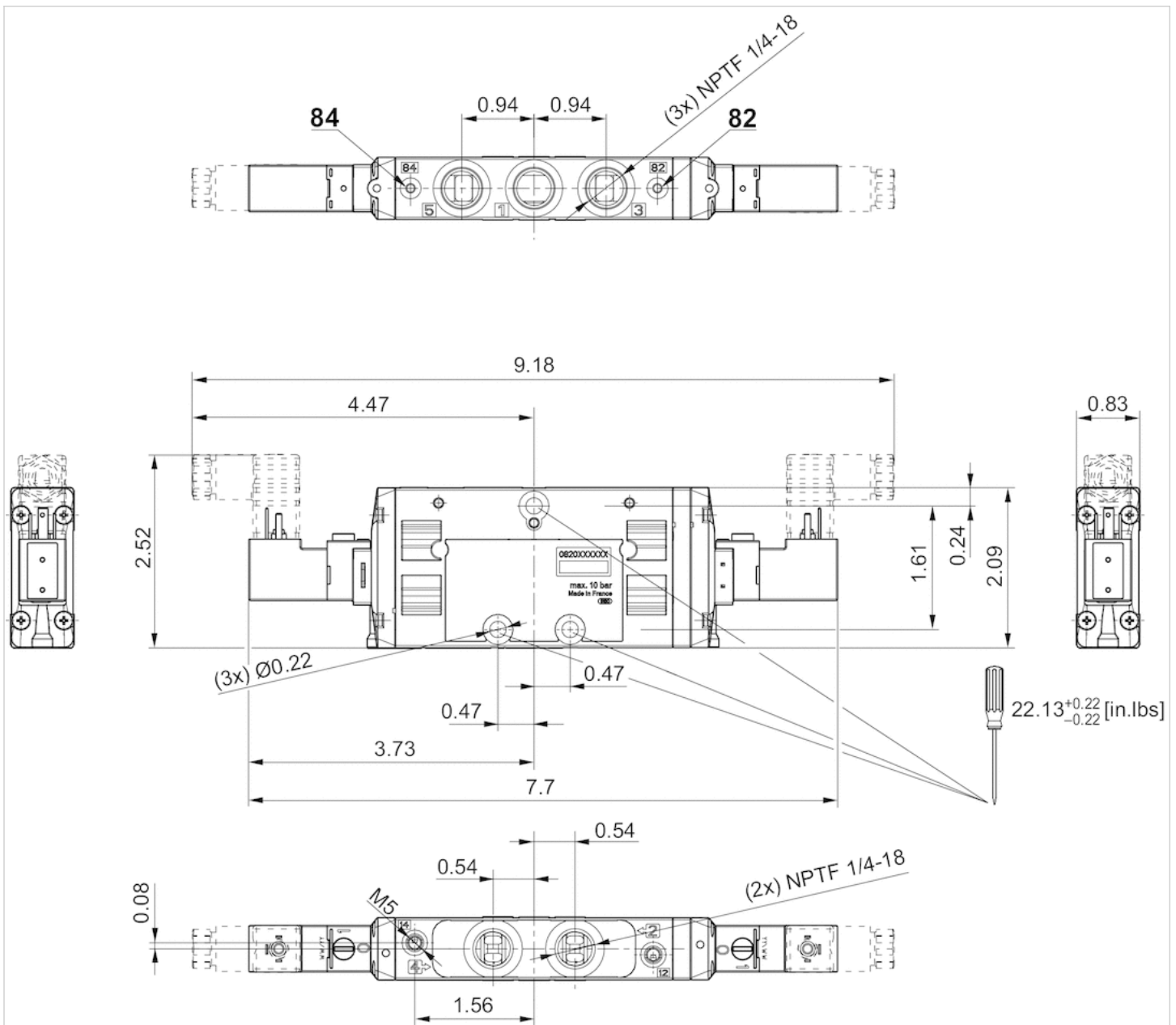



2x3/2-directional valve, Series TC15

- Qn = 1100 l/min
- Compressed air connection output G 1/4
- Pipe connection



Version	Spool valve
Activation	pneumatically
Sealing principle	Soft sealing
Flow rate value Qn	1100 l/min
Working pressure min./max.	-0.9 ... 10 bar
Control pressure min./max.	3 ... 10 bar
Ambient temperature min./max.	-10 ... 50 °C
Medium temperature min./max.	-10 ... 50 °C
Medium	Compressed air
Max. particle size	5 µm
Oil content of compressed air	0 ... 5 mg/m ³
Mounting on manifold strip	P-strip
Mounting screw tightening torque	2.5 Nm
Weight	0.208 kg

Technical data

Part No.			Compressed air connection	
			Input	Output
R422102229		NC/NC	G 1/4	G 1/4
R422102230		NO/NO	G 1/4	G 1/4
R422102231		NC/NO	G 1/4	G 1/4

Part No.	Compressed air connection		Flow conductance b
	Exhaust	Pilot control exhaust	
R422102229	G 1/4	M5	0.25
R422102230	G 1/4	M5	0.25
R422102231	G 1/4	M5	0.25

Part No.	Flow conductance C-value
	R422102229
R422102230	5.9 l/(s*bar)
R422102231	5.9 l/(s*bar)

Nominal flow Qn at 6 bar and $\Delta p = 1$ bar, Caution: The minimum control pressure depends on the working pressure (see "Control pressure" diagram below).

Technical information

The min. control pressure must be adhered to, since otherwise faulty switching and valve failure may result!

The pressure dew point must be at least 15 °C under ambient and medium temperature and may not exceed 3 °C .

The oil content of compressed air must remain constant during the life cycle.

Use only the approved oils from AVENTICS. Further information can be found in the "Technical information" document (available in the MediaCentre).

Technical information

Material	
Housing	Polyamide fiber-glass reinforced
Seals	Acrylonitrile butadiene rubber
Front plate	Polyamide fiber-glass reinforced
Threaded bushing	Brass Die cast zinc, chrome-plated nickel-plated

Dimensions

Dimensions

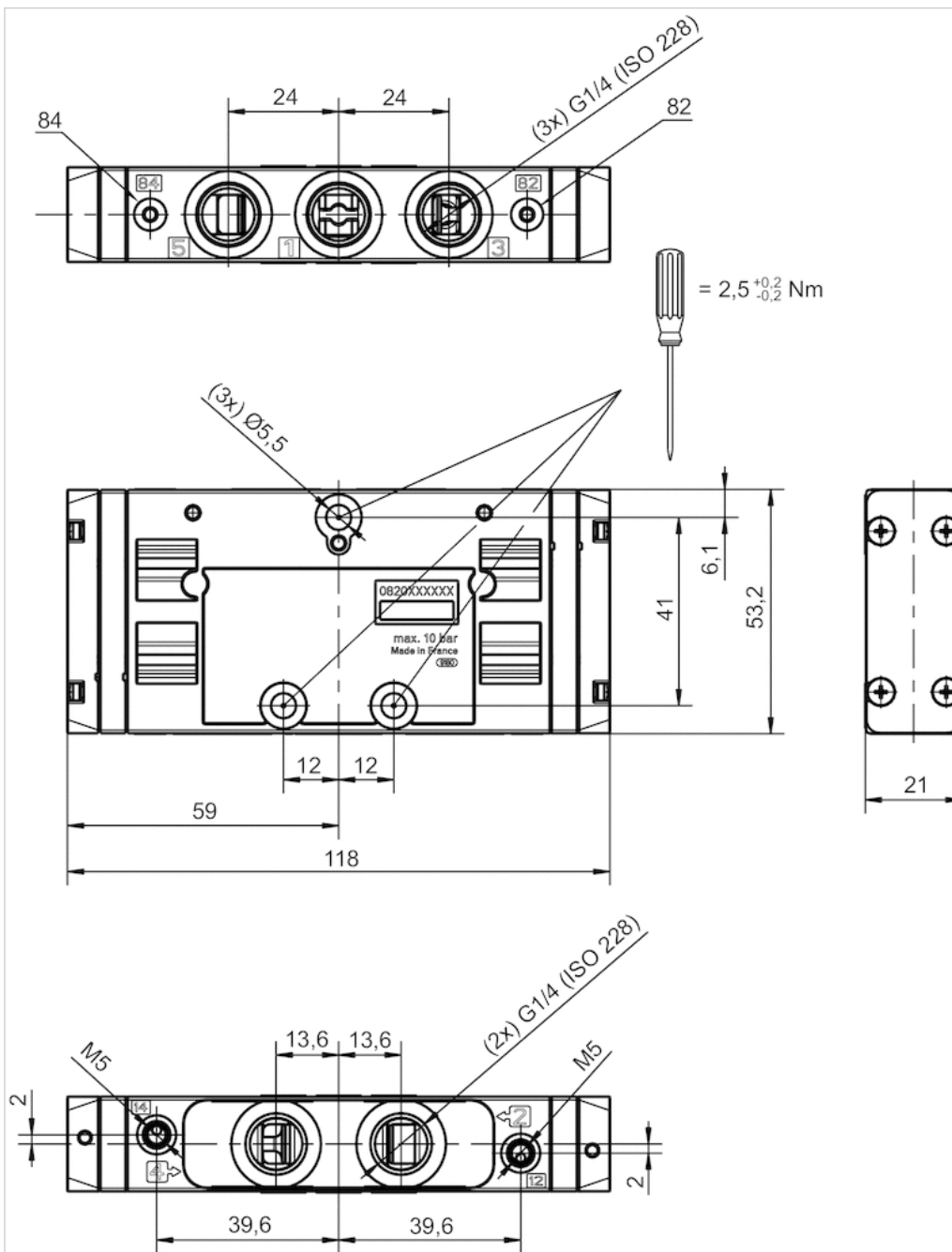

Diagrams

Control pressure

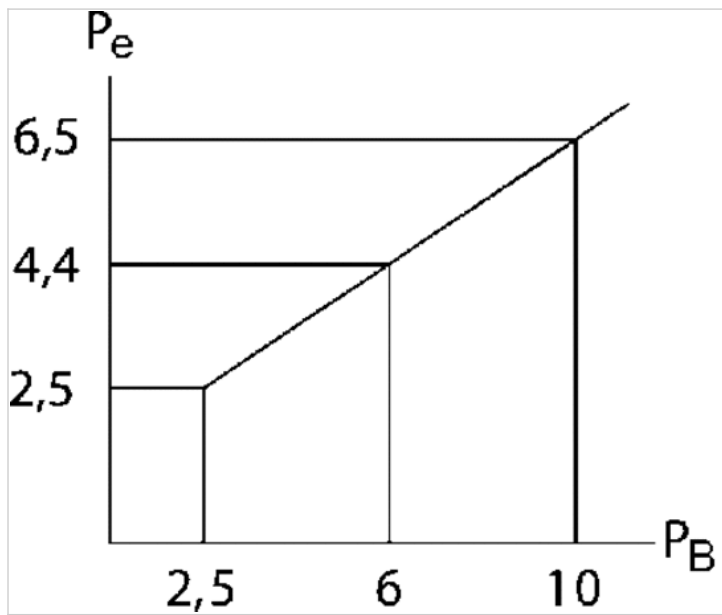

Pe = external control pressure, min.

PB= Working pressure





5/2-directional valve, Series TC15

- Qn = 1500 l/min
- Compressed air connection output G 1/4
- Pipe connection



Version	Spool valve, positive overlapping
Activation	pneumatically
Pilot	External
Sealing principle	Soft sealing
Flow rate value Qn	1500 l/min
Working pressure min./max.	See table below
Control pressure min./max.	See table below
Ambient temperature min./max.	-10 ... 50 °C
Medium temperature min./max.	-10 ... 50 °C
Medium	Compressed air
Max. particle size	5 µm
Oil content of compressed air	0 ... 5 mg/m ³
Mounting on manifold strip	P-strip
Mounting screw tightening torque	2.5 Nm
Weight	0.188 kg

Technical data

Part No.		Compressed air connection	
		Input	Output
0820258001		G 1/4	G 1/4
0820258002		G 1/4	G 1/4
0820258003		G 1/4	G 1/4
0820258004		G 1/4	G 1/4

Part No.	Compressed air connection		Flow conductance b
	Exhaust	Pilot control exhaust	
0820258001	G 1/4	M5	0.33
0820258002	G 1/4	M5	0.33
0820258003	G 1/4	M5	0.33
0820258004	G 1/4	M5	0.33

Part No.	Flow conductance C-value		Working pressure min./max.	Control pressure min./max.
0820258001	6.8 l/(s*bar)		2.5 ... 10 bar	2.5 ... 10 bar
0820258002	6.8 l/(s*bar)		-0.9 ... 10 bar	3 ... 10 bar
0820258003	6.8 l/(s*bar)		-0.9 ... 10 bar	2 ... 10 bar
0820258004	6.8 l/(s*bar)		-0.9 ... 10 bar	2.5 ... 10 bar

Caution: The minimum control pressure depends on the working pressure (see "Control pressure" diagram below).

Technical information

The min. control pressure must be adhered to, since otherwise faulty switching and valve failure may result!

The pressure dew point must be at least 15 °C under ambient and medium temperature and may not exceed 3 °C .

The oil content of compressed air must remain constant during the life cycle.

Use only the approved oils from AVENTICS. Further information can be found in the "Technical information" document (available in the MediaCentre).

Technical information

Material	
Housing	Polyamide fiber-glass reinforced
Seals	Acrylonitrile butadiene rubber
Front plate	Polyamide fiber-glass reinforced
Threaded bushing	Brass Die cast zinc, chrome-plated nickel-plated

Dimensions

Dimensions

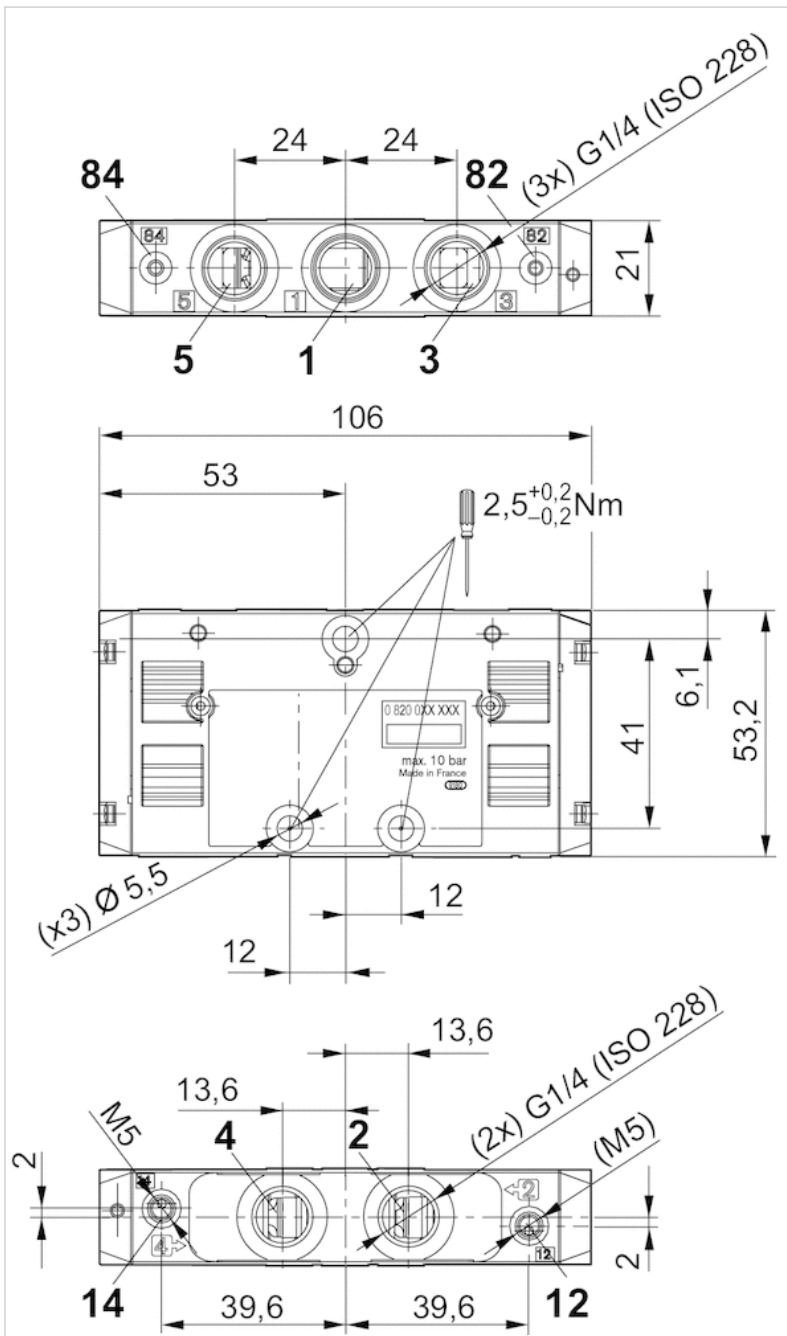

Diagrams

Control pressure

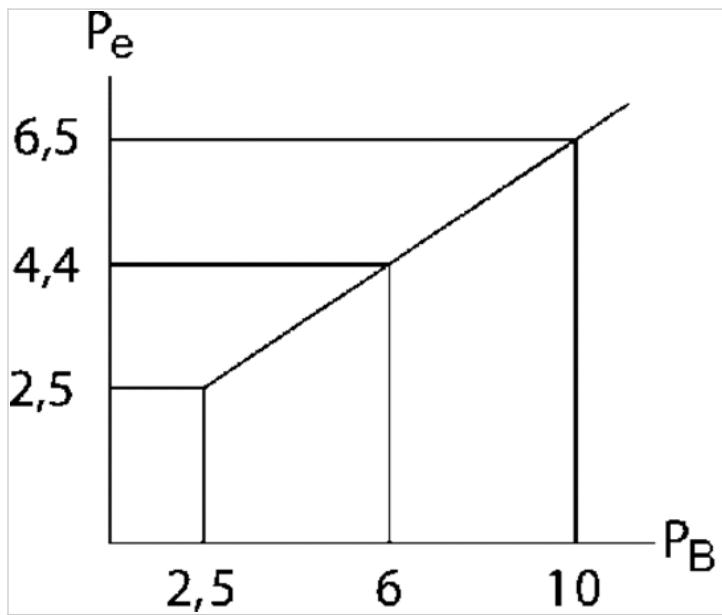

Pe = external control pressure, min.

PB= Working pressure



5/3-directional valve, Series TC15

- Qn = 1300 l/min
- Compressed air connection output G 1/4
- Pipe connection



Version	Spool valve, positive overlapping
Activation	pneumatically
Pilot	External
Sealing principle	Soft sealing
Flow rate value Qn	1300 l/min
Working pressure min./max.	-0.9 ... 10 bar
Control pressure min./max.	3 ... 10 bar
Ambient temperature min./max.	-10 ... 50 °C
Medium temperature min./max.	-10 ... 50 °C
Medium	Compressed air
Max. particle size	5 µm
Oil content of compressed air	0 ... 5 mg/m ³
Mounting on manifold strip	P-strip
Mounting screw tightening torque	2.5 Nm
Weight	0.203 kg

Technical data

Part No.			Compressed air connection	
				Input
0820259001		closed center		G 1/4
0820259002		exhausted center		G 1/4
0820259003		pressurized center		G 1/4

Part No.	Compressed air connection	
	Output	Exhaust
0820259001	G 1/4	G 1/4
0820259002	G 1/4	G 1/4
0820259003	G 1/4	G 1/4

Part No.	Compressed air connection		Flow conductance	Flow conductance
	Pilot control exhaust		b	C-value
0820259001	M5		0.31	5.9 l/(s*bar)
0820259002	M5		0.31	5.9 l/(s*bar)
0820259003	M5		0.31	5.9 l/(s*bar)

Technical information

The min. control pressure must be adhered to, since otherwise faulty switching and valve failure may result!
 The pressure dew point must be at least 15 °C under ambient and medium temperature and may not exceed 3 °C .
 The oil content of compressed air must remain constant during the life cycle.
 Use only the approved oils from AVENTICS. Further information can be found in the "Technical information" document (available in the MediaCentre).

Technical information

Material

Housing	Polyamide fiber-glass reinforced
Seals	Acrylonitrile butadiene rubber
Front plate	Polyamide fiber-glass reinforced
Threaded bushing	Brass Die cast zinc, chrome-plated nickel-plated

Dimensions

Dimensions

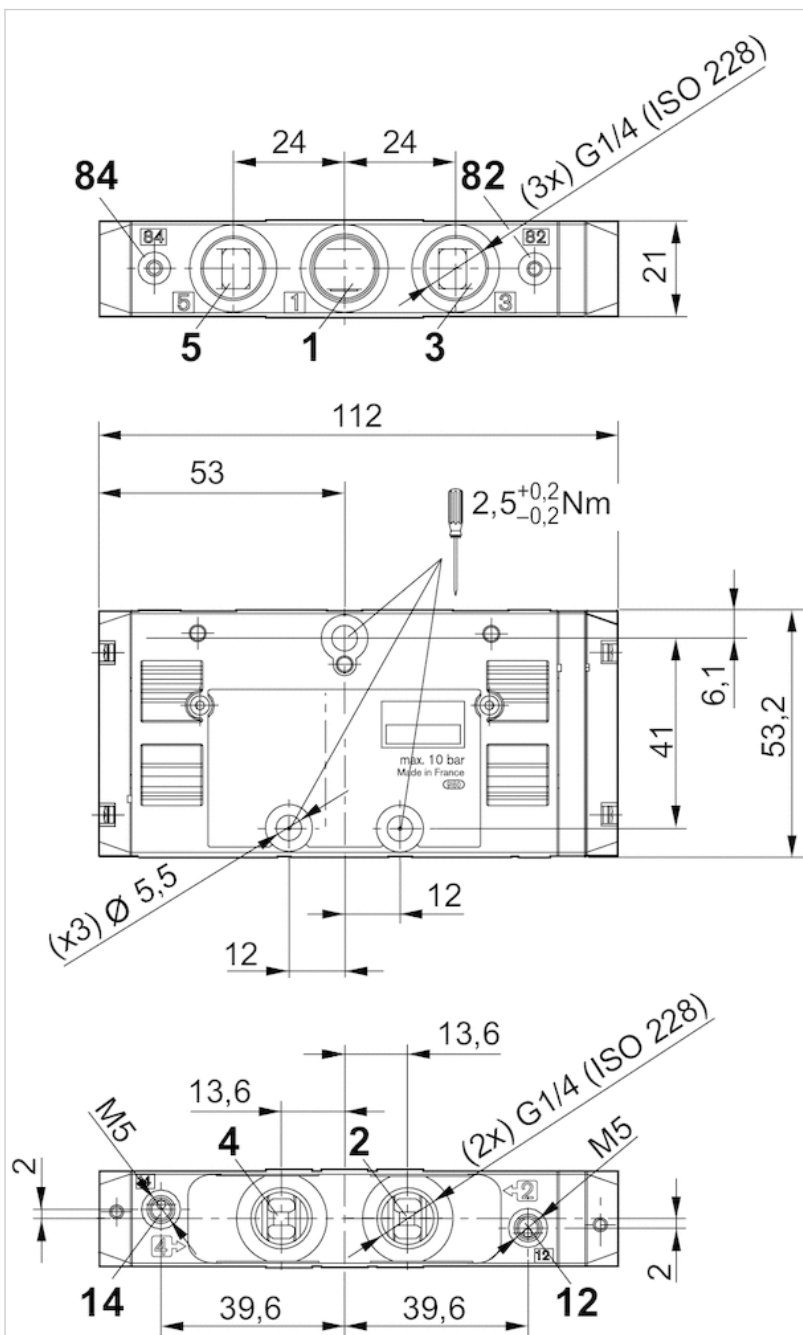

Diagrams

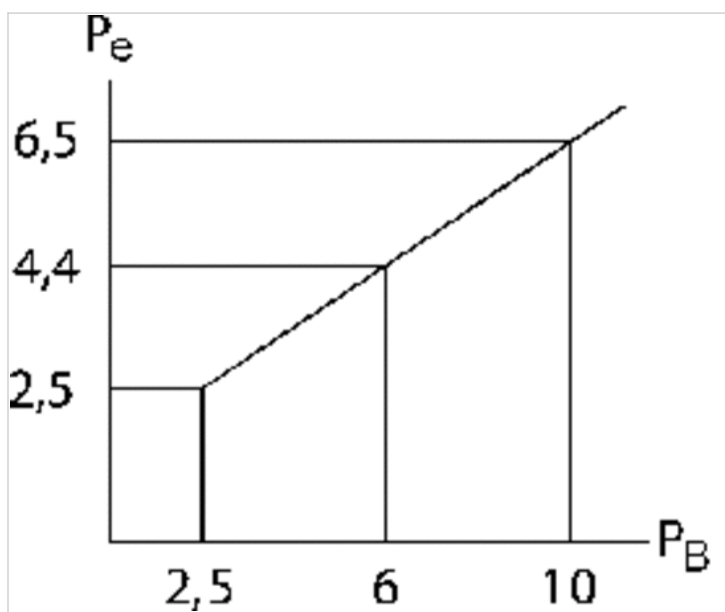

Coil, Series C01

- Form C, coil kit
- Coil width 15 mm
- Power consumption DC 2 W
- Holding power AC 1.6 VA
- Switch-on power AC 2.2 VA



Connector standard	ISO 15217
electrical connections	Plug, 3-pin
Ambient temperature min./max.	-10 ... 50 °C
Protection class With valve plug connector/plug	IP65
Duty cycle ED	100 %
Weight	See table below

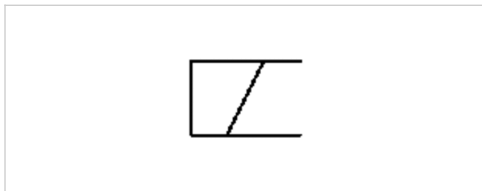

Technical data

Part No.	Operational voltage	Operational voltage	Operational voltage
	DC	AC 50 Hz	AC 60 Hz
R422101598	-	110 V	110 V
R422101599	-	230 V	230 V
R422101600	24 V	-	-
R422101601	-	24 V	24 V
R422101602	12 V	-	-

Part No.	Voltage tolerance	Voltage tolerance	Voltage tolerance	Power consumption
	DC	AC 50 Hz	AC 60 Hz	DC
R422101598	-	-10% / +10%	-10% / +10%	-
R422101599	-	-10% / +10%	-10% / +10%	-
R422101600	-10% / +10%	-	-	2 W
R422101601	-	-10% / +10%	-10% / +10%	-
R422101602	-10% / +10%	-	-	2 W

Part No.	Holding power	Holding power	Switch-on power	Switch-on power	Weight	
	AC 50 Hz	AC 60 Hz	AC 50 Hz	AC 60 Hz		
R422101598	1.6 VA	1.4 VA	2.2 VA	2 VA	0.023 kg	1)
R422101599	1.6 VA	1.4 VA	2.2 VA	2 VA	0.022 kg	1)
R422101600	-	-	-	-	0.024 kg	-
R422101601	1.6 VA	1.4 VA	2.2 VA	2 VA	0.023 kg	1)

Part No.	Holding power	Holding power	Switch-on power	Switch-on power	Weight	
	AC 50 Hz	AC 60 Hz	AC 50 Hz	AC 60 Hz		
R422101602	-	-	-	-	0.024 kg	-

1) Can only be combined with TC series base valves and TC series valves with alternating voltage (AC).

Technical information

Please note that the coils are only compatible with TC series valves that were produced starting in 2011.

Technical information

Material	
Housing	Polyamide

Dimensions

Dimensions

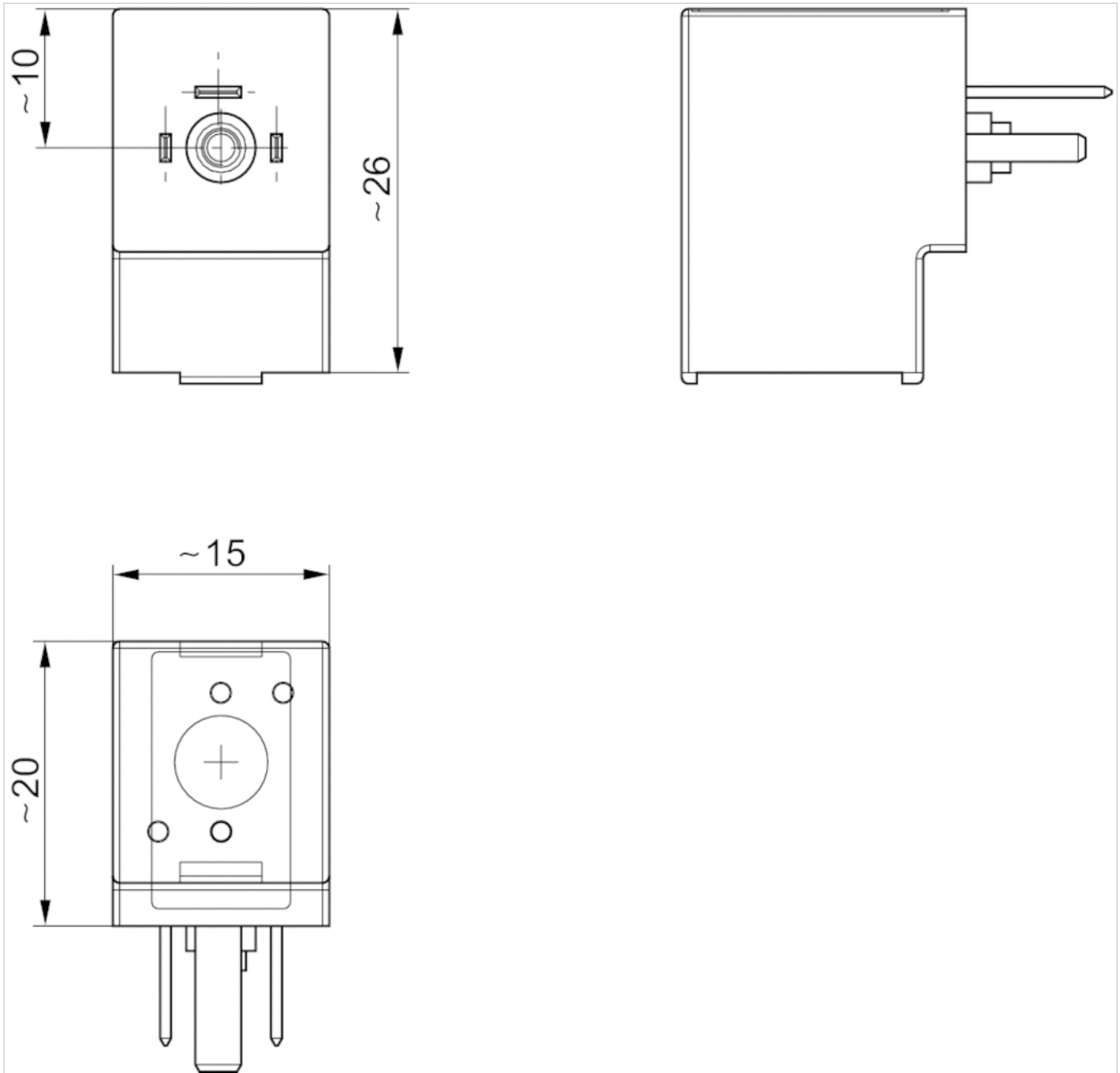

Coil, Series C01

- M8, coil kit
- Coil width 15 mm
- Power consumption DC 2.2 W



Connector standard	DIN EN 60947-5-2
electrical connections	See table below
Ambient temperature min./max.	-10 ... 50 °C
Protection class acc. to DIN EN 61140	Class III
Electrically	
Protection class With valve plug connector/plug	IP65
Duty cycle ED	100 %
LED status display	Yellow
Weight	0.025 kg

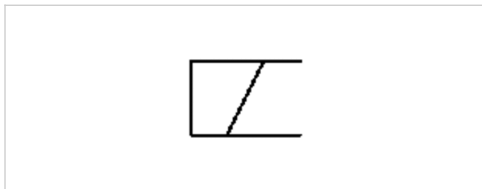

Technical data

Part No.	electrical connections	Operational voltage	Voltage tolerance
		DC	DC
R422101603	Plug, M8x1, 4-pin	24 V	-10% / +10%
R422101604	Plug, M8x1, 3-pin	24 V	-10% / +10%

Part No.	Power consumption
	DC
R422101603	2.2 W
R422101604	2.2 W

Technical information

Please note that the coils are only compatible with TC series valves that were produced starting in 2011.

Technical information

Material	
Housing	Polyamide

Dimensions

Dimensions

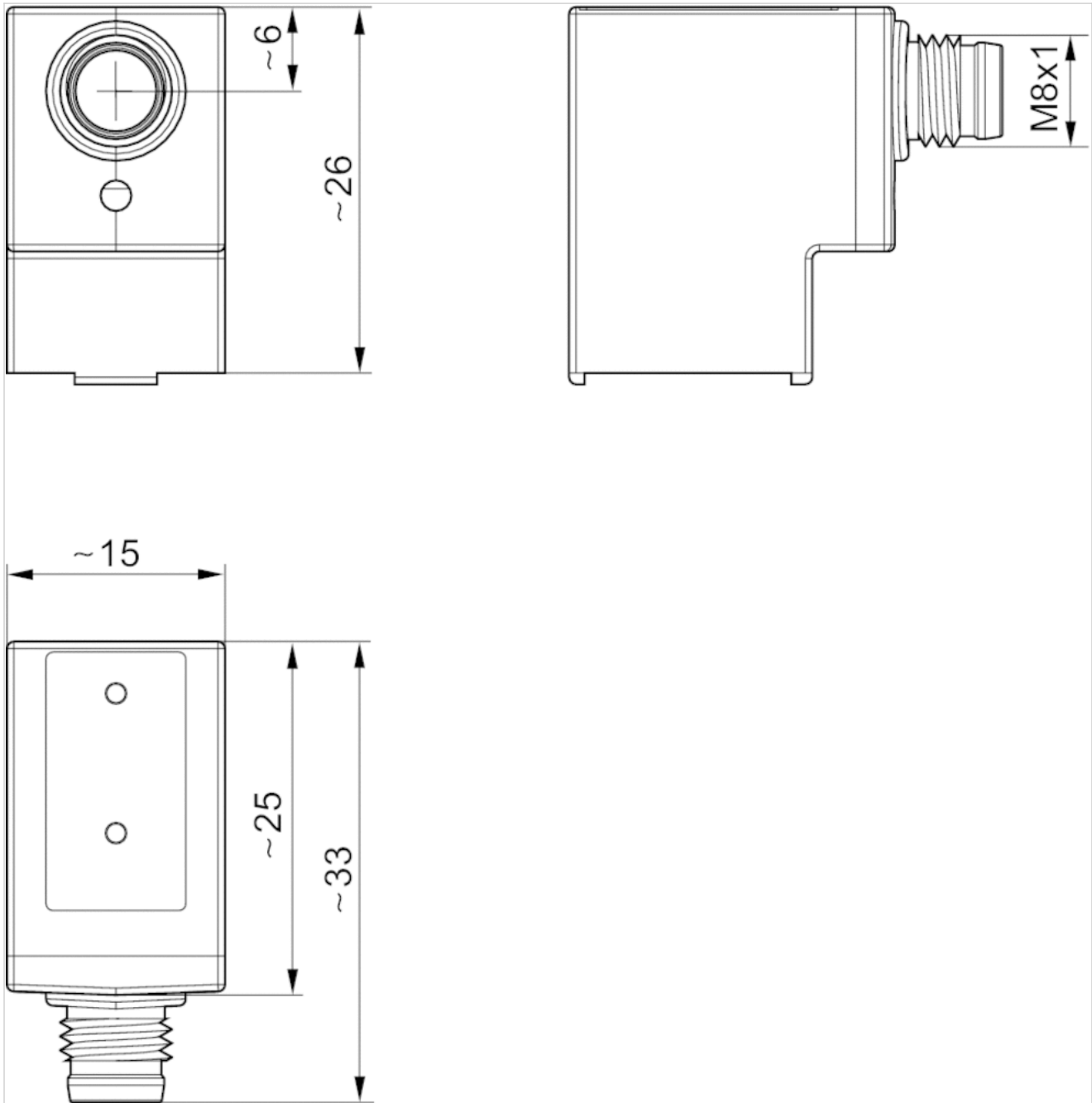

Valve plug connector, series CON-VP

- Socket form C 2+E angled 90°
- open cable ends 3-pin
- with cable
- unshielded

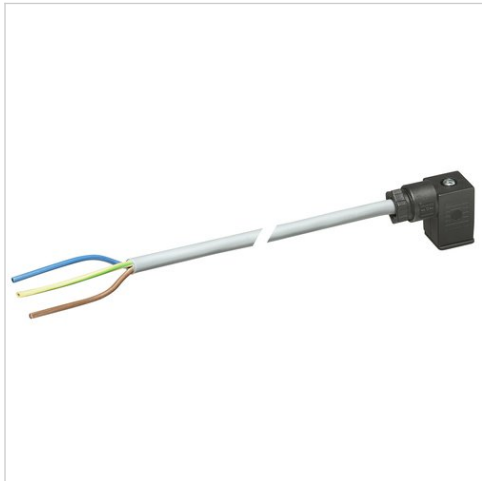

Ambient temperature min./max.	-20 ... 80 °C
Operational voltage	See table below
Protection class	IP67
Wire cross-section	0.75 mm ²
Mounting screw tightening torque	0.4 Nm
Weight	See table below

Technical data

Part No.		Operational voltage	Max. current	Protective circuit	Contact assignment
1834484212		230 V AC/DC	6 A	-	2+E
1834484213		230 V AC/DC	6 A	-	2+E
1834484214		230 V AC/DC	6 A	-	2+E
1834484215		230 V AC/DC	6 A	-	2+E
1834484204		24 V AC/DC	6 A	Z-diode	2+E
1834484205		24 V AC/DC	6 A	Z-diode	2+E
1834484206		24 V AC/DC	6 A	Z-diode	2+E
1834484207		24 V AC/DC	6 A	Z-diode	2+E
1834484208		230 V AC/DC	6 A	Varistor	2+E
1834484209		230 V AC/DC	6 A	Varistor	2+E
1834484210		230 V AC/DC	6 A	Varistor	2+E
1834484211		230 V AC/DC	6 A	Varistor	2+E
1834484236		24 V AC/DC	6 A	Z-diode	2+E

Part No.	LED status display	Number of wires	Cable-Ø	Cable length	Weight	Fig.	
1834484212	-	3	5.9 mm	3 m	0.183 kg	Fig. 1	-
1834484213	-	3	5.9 mm	3 m	0.183 kg	Fig. 2	-
1834484214	-	3	5.9 mm	5 m	0.308 kg	Fig. 1	-
1834484215	-	3	5.9 mm	5 m	0.308 kg	Fig. 2	-
1834484204	Yellow	3	5.9 mm	3 m	0.185 kg	Fig. 1	1)
1834484205	Yellow	3	5.9 mm	3 m	0.185 kg	Fig. 2	1)
1834484206	Yellow	3	5.9 mm	5 m	0.292 kg	Fig. 1	1)
1834484207	Yellow	3	5.9 mm	5 m	0.298 kg	Fig. 2	1)
1834484208	Yellow	3	5.9 mm	3 m	0.171 kg	Fig. 1	1)
1834484209	Yellow	3	5.9 mm	3 m	0.194 kg	Fig. 2	1)
1834484210	Yellow	3	5.9 mm	5 m	0.297 kg	Fig. 1	1)

Part No.	LED status display	Number of wires	Cable-Ø	Cable length	Weight	Fig.	
1834484211	Yellow	3	5.9 mm	5 m	0.285 kg	Fig. 2	1)
1834484236	Yellow	3	5.9 mm	10 m	0.571 kg	Fig. 2	1)

1) Scope of delivery incl. flat gasket

Technical information

The specified protection class is only valid in assembled and tested state.

Technical information

Material	
Seals	caoutchouc/butadiene caoutchouc
Cable sheath	Polyvinyl chloride

Dimensions

Fig. 1

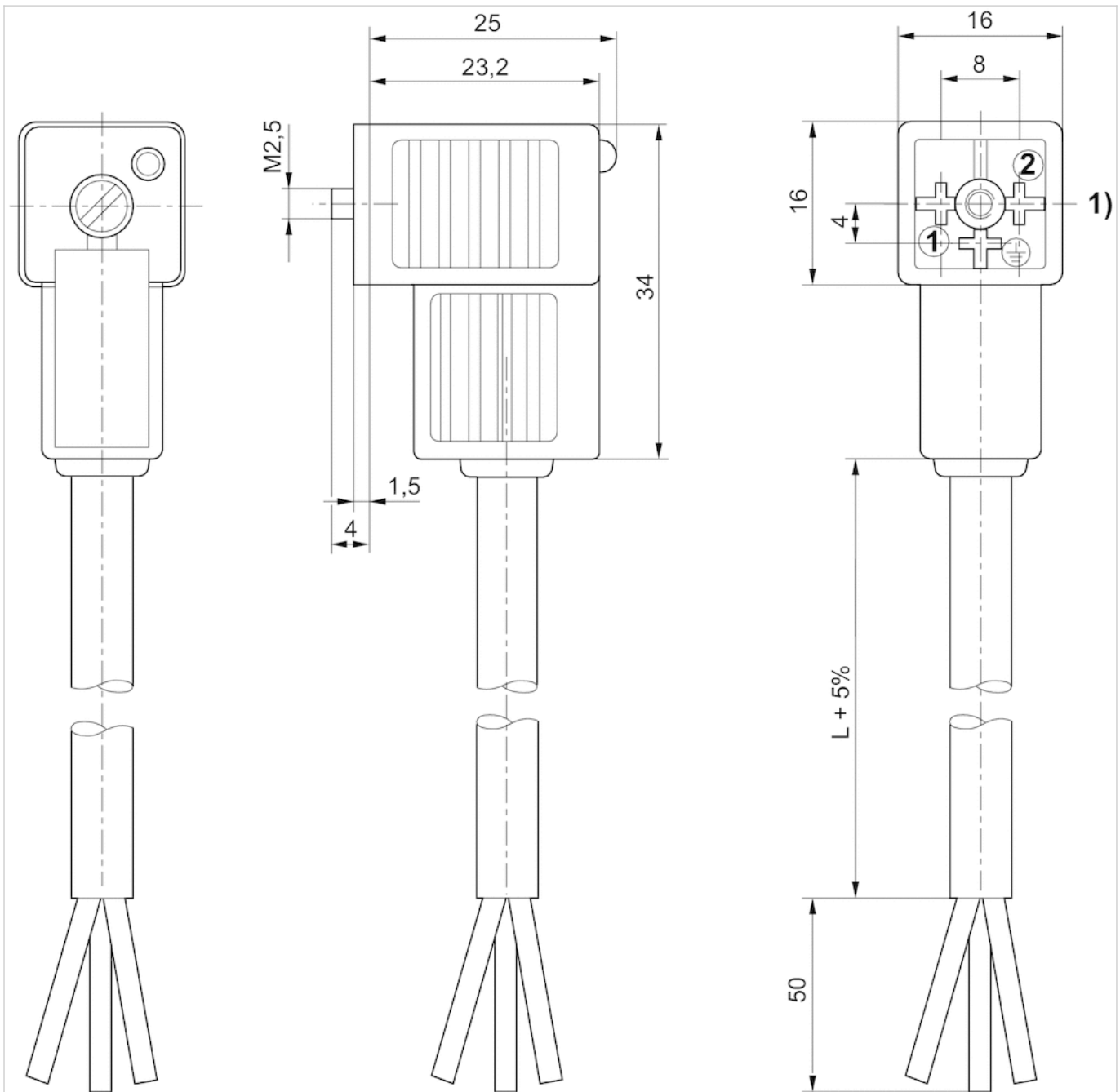

1) 0° female insert

Fig. 2

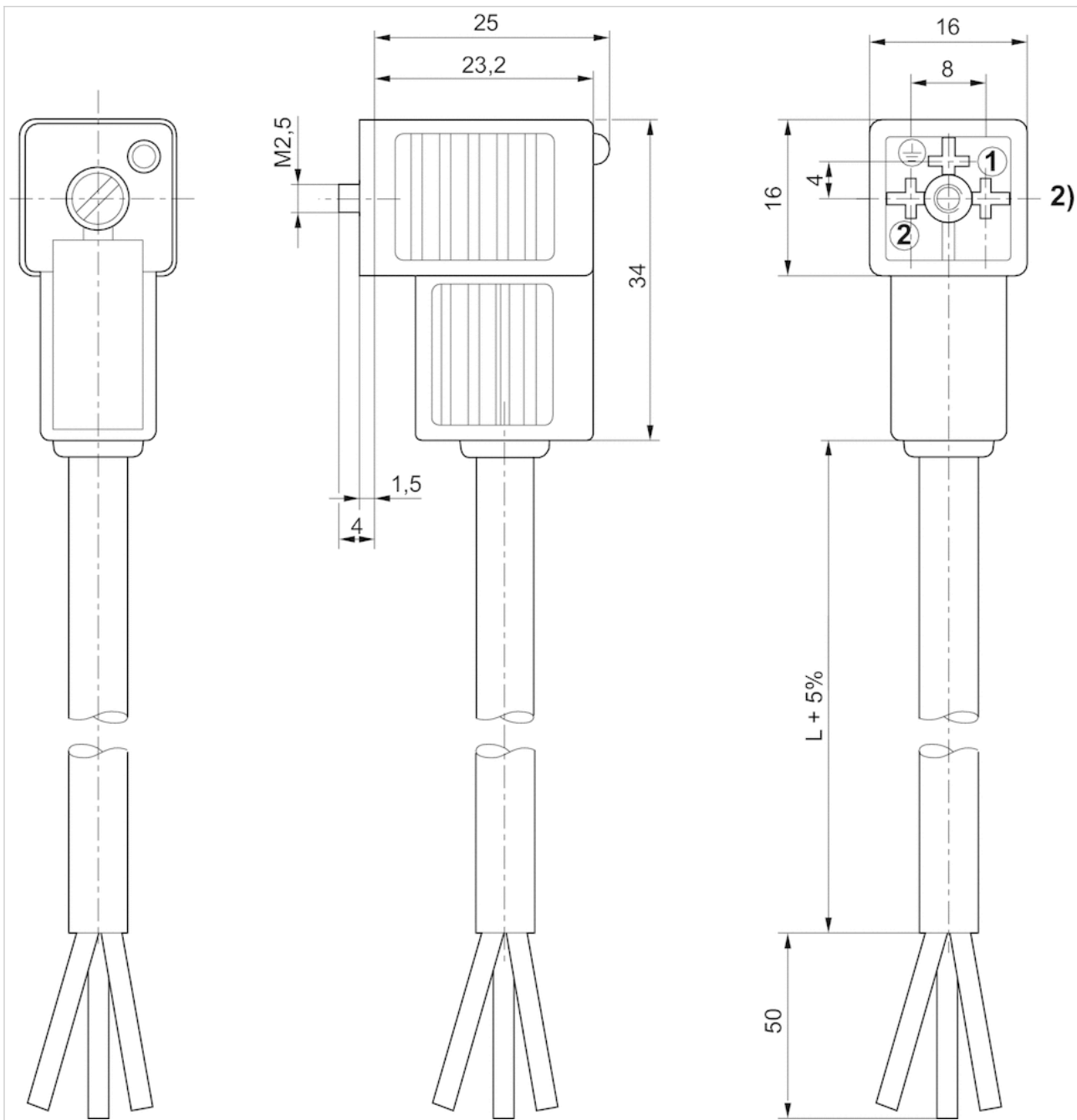

2) 180° female insert



Valve plug connector, series CON-VP

- Socket, form C, 2+E, angled, 90°
- ISO 15217
- unshielded
- with LED Green

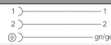

Connection type	Screws
Ambient temperature min./max.	-40 ... 90 °C
Operational voltage	See table below
Protection class	IP65
Mounting screw tightening torque	0.4 Nm
Weight	See table below

Technical data

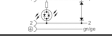
Part No.		Operational voltage	Max. current	Protective circuit	Contact assignment
1834484187		250 / 300 V AC/DC	6 A	-	2+E
8941012202		250 / 300 V AC/DC	6 A	-	2+E
4402050330		24 V AC/DC	-	Z-diode	2+E

Part No.	LED status display	suitable cable-Ø min./max	Seal	Weight
1834484187	-	4 / 8 mm	caoutchouc/butadiene caoutchouc	0.012 kg
8941012202	-	4 / 8 mm	-	0.012 kg
4402050330	Green	-	-	0.014 kg

Part No.	Fig.	
1834484187	Fig. 1	-
8941012202	Fig. 2	-
4402050330	Fig. 3	1)

1)

Technical information

The specified protection class is only valid in assembled and tested state.

Technical information

Material

Seals

caoutchouc/butadiene caoutchouc

Dimensions

Fig. 1

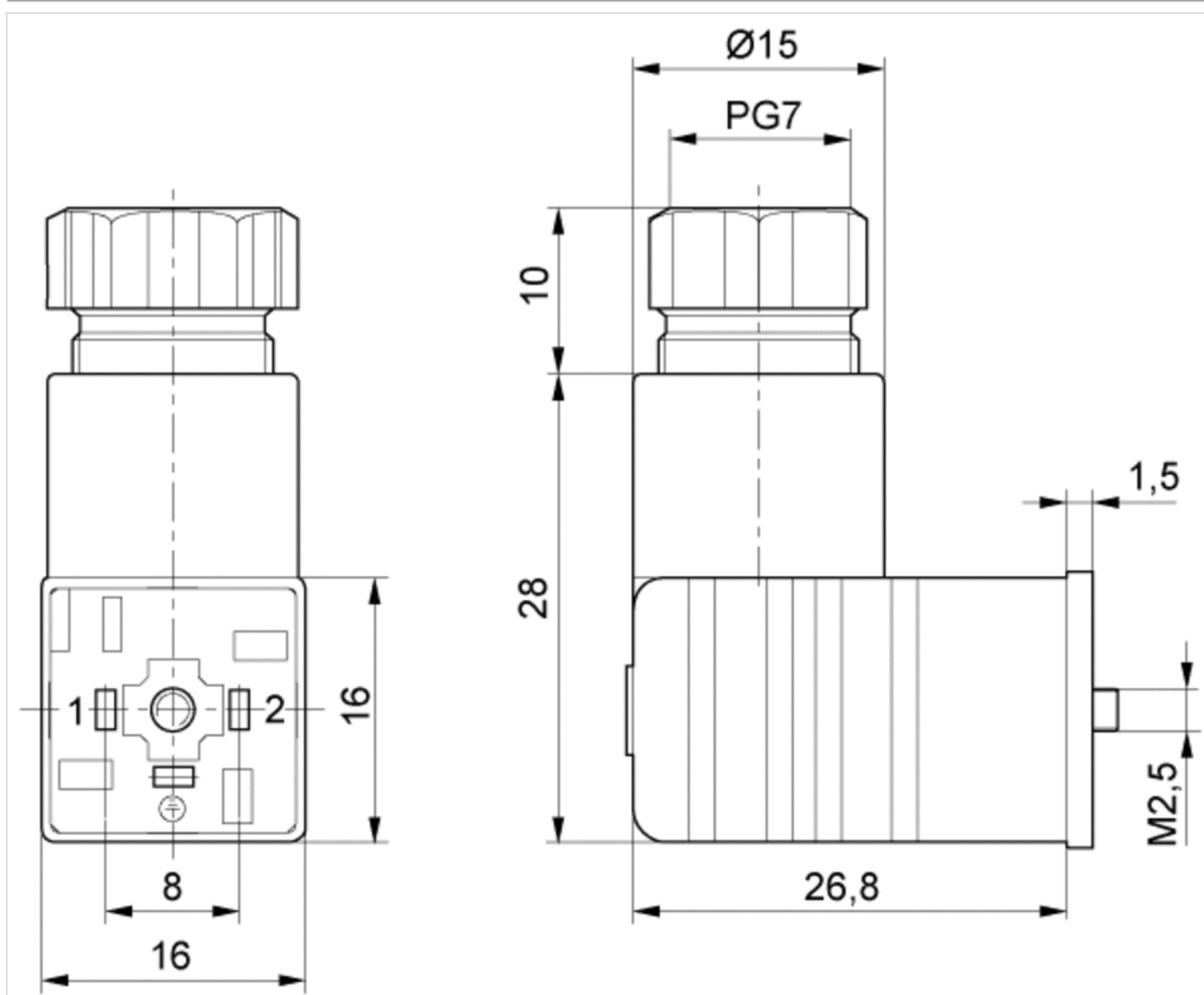

Fig. 2

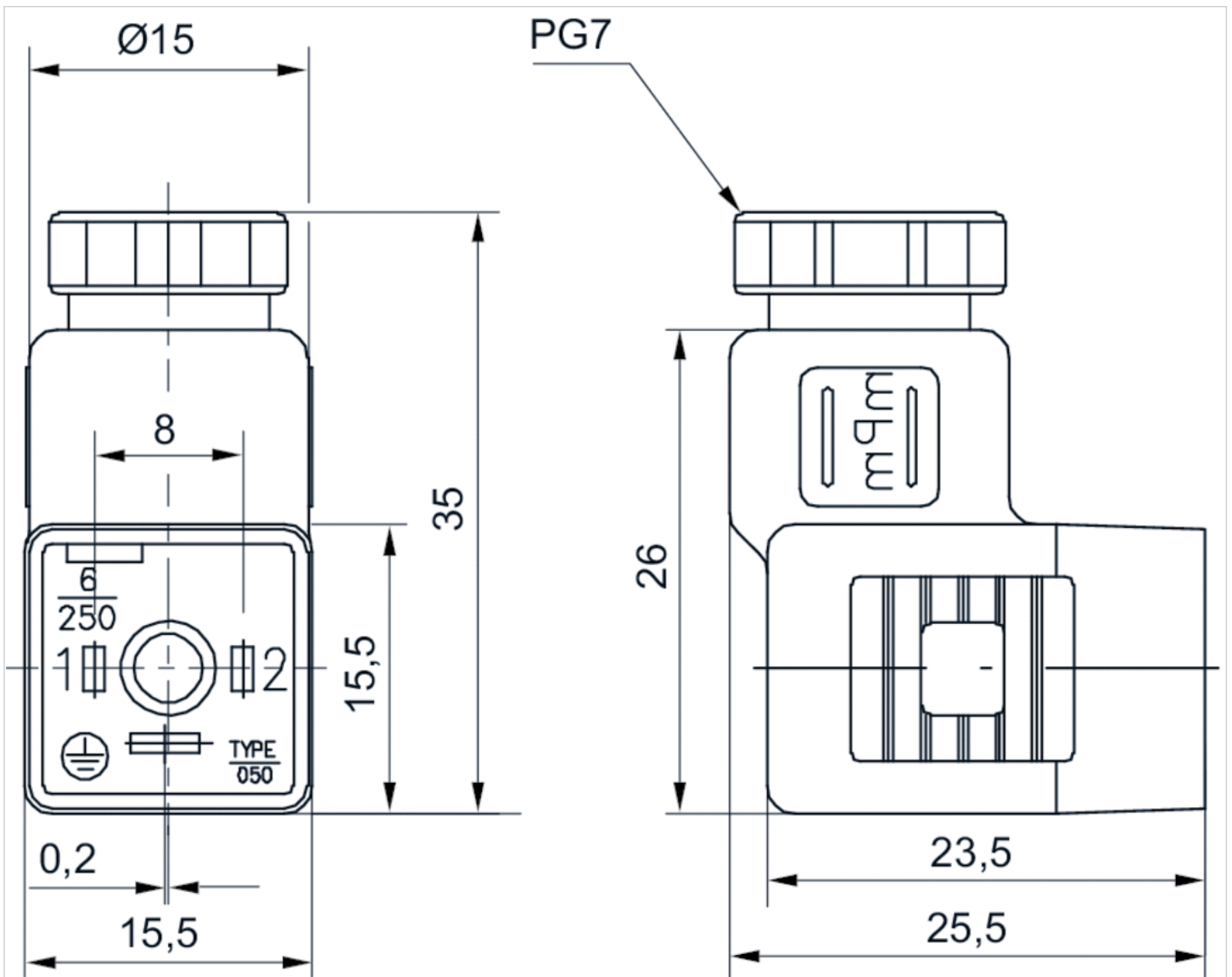
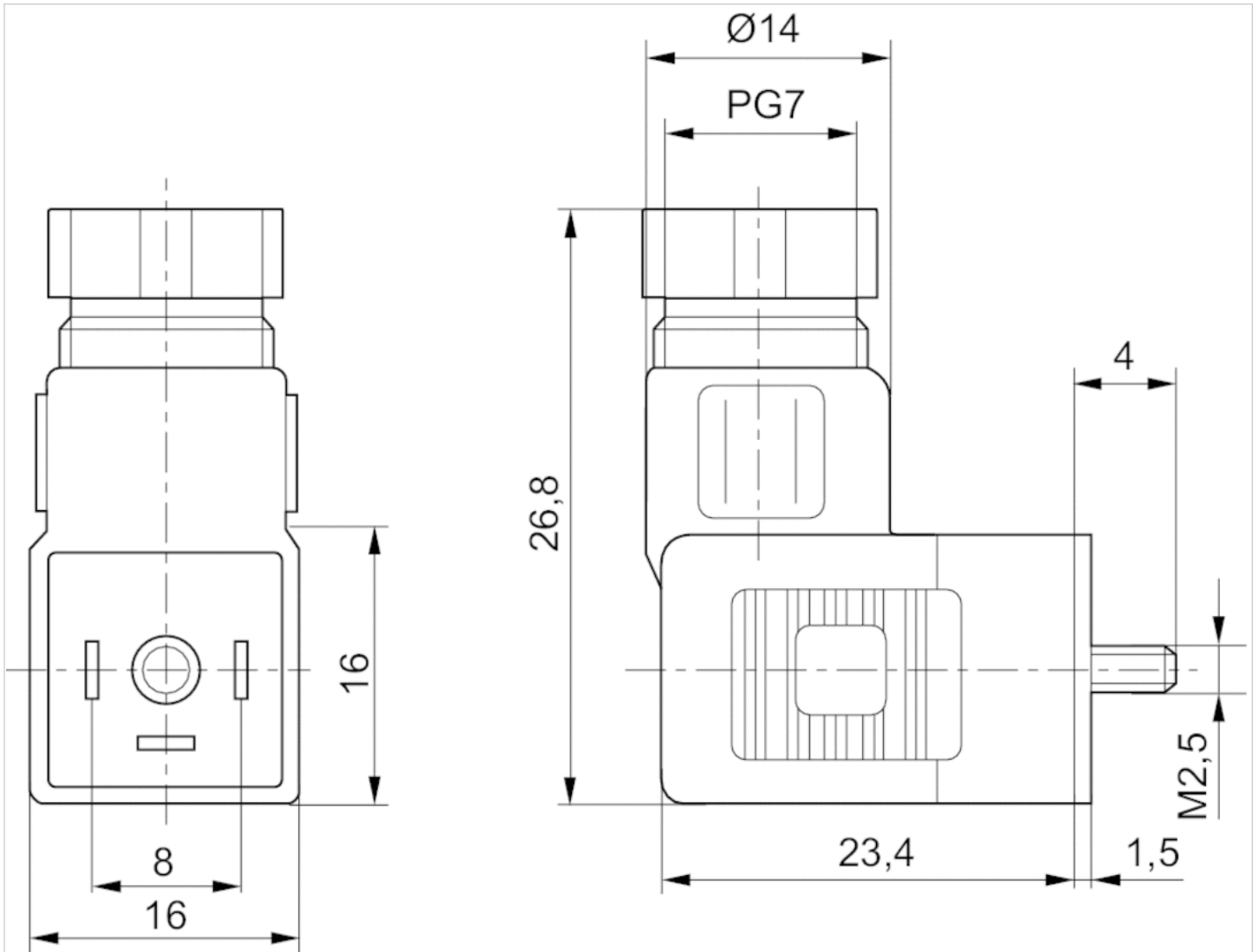

Fig. 3



Round plug connector, Series CON-RD

- Socket M8x1 3-pin A-coded straight 180°
- open cable ends
- with cable
- UL (Underwriters Laboratories)
- unshielded



Ambient temperature min./max.	-25 ... 85 °C
Operational voltage	48 V AC/DC
Protection class	IP67
Wire cross-section	0.24 mm ²
Weight	See table below

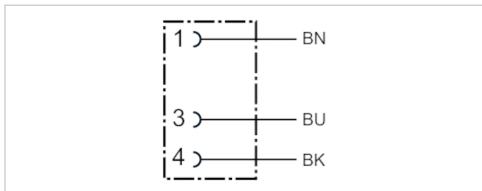

Technical data

Part No.	Max. current	Number of wires	Cable-Ø	Cable length	Certification	Weight
1834484166	4 A	3	4.5 mm	3 m	UL (Underwriters Laboratories)	0.087 kg
1834484168	4 A	3	4.5 mm	5 m	UL (Underwriters Laboratories)	0.141 kg
1834484247	4 A	3	4.5 mm	10 m	UL (Underwriters Laboratories)	0.277 kg

Technical information

The specified protection class is only valid in assembled and tested state.

Technical information

Material	
Housing	Polyurethane
Cable sheath	Polyurethane

Dimensions

Dimensions

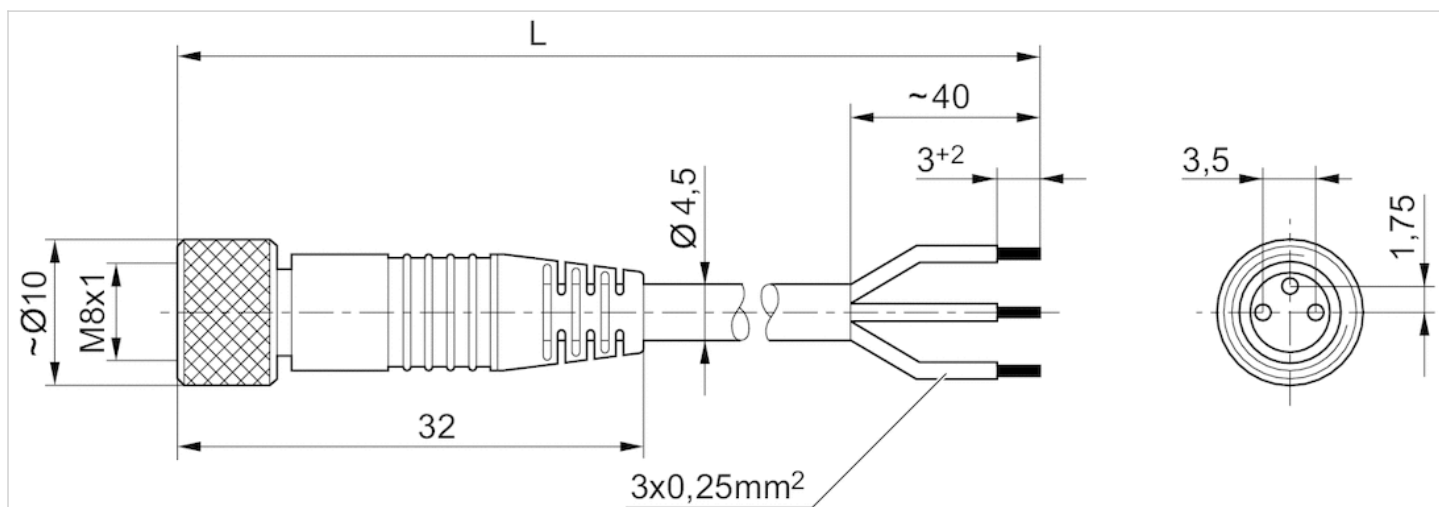

L = length

Pin assignments

Pin assignment, socket

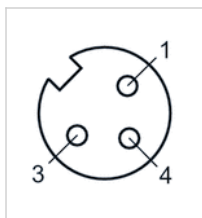

- (1) BN=brown
- (3) BU=blue
- (4) BK=black

Round plug connector, Series CON-RD

- Socket M8x1 3-pin A-coded angled 90°
- open cable ends
- with cable
- unshielded



Ambient temperature min./max.	-40 ... 85 °C
Operational voltage	48 V AC/DC
Protection class	IP67
Wire cross-section	0.24 mm ²
Weight	See table below

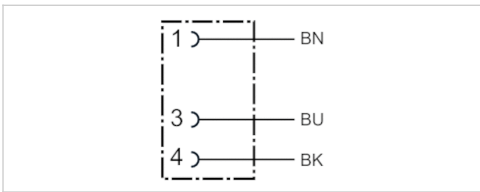

Technical data

Part No.	Max. current	Number of wires	Cable-Ø	Cable length	Weight
1834484167	4 A	3	4.5 mm	3 m	0.087 kg
1834484169	4 A	3	4.5 mm	5 m	0.139 kg
1834484248	4 A	3	4.5 mm	10 m	0.279 kg

Technical information

The specified protection class is only valid in assembled and tested state.

Technical information

Material	
Housing	Polyurethane
Cable sheath	Polyurethane

Dimensions

Dimensions

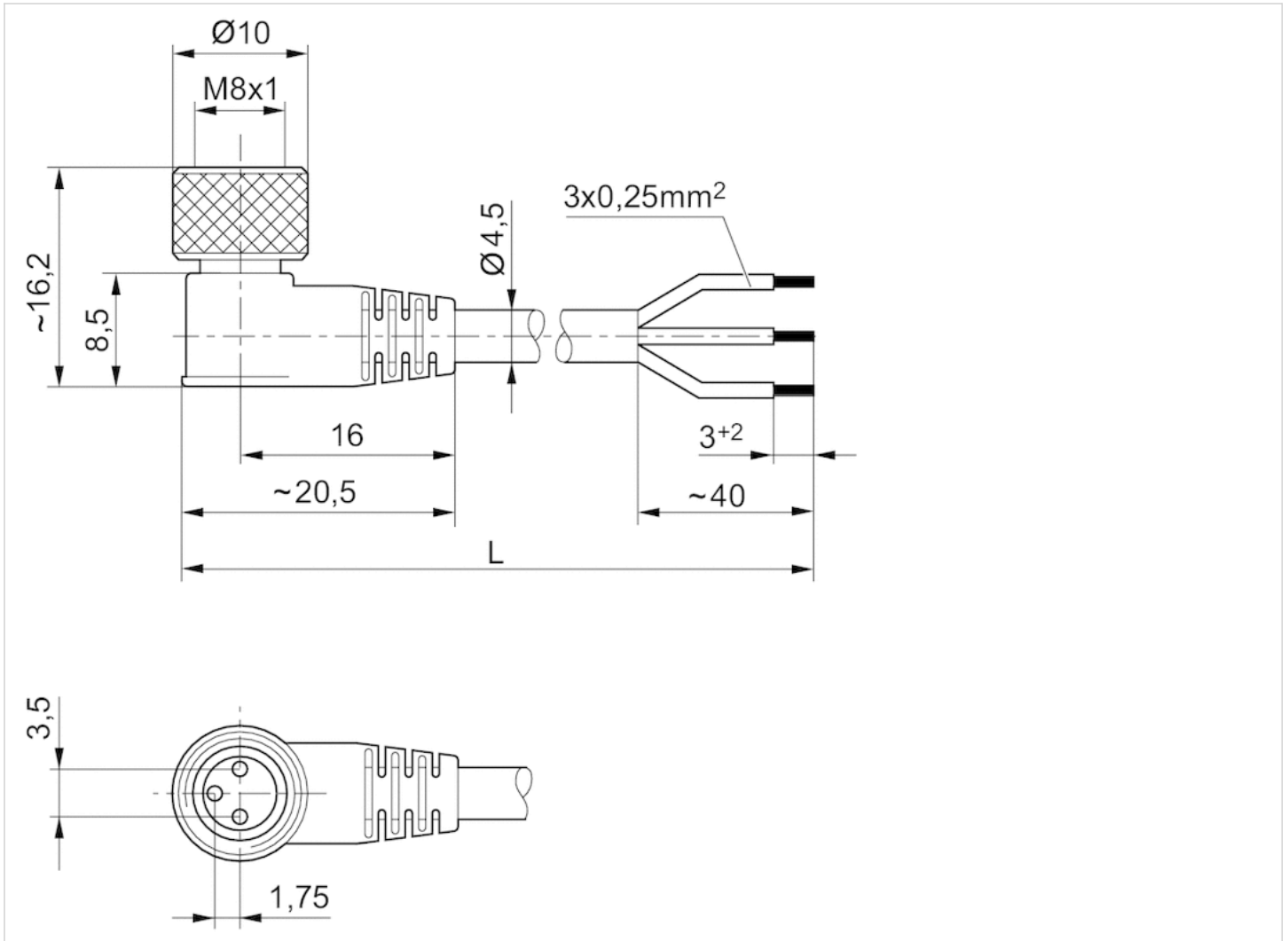

L = length

Pin assignments

Pin assignment, socket

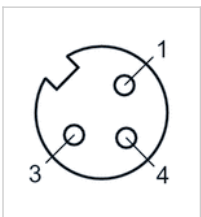

- (1) BN=brown
- (3) BU=blue
- (4) BK=black

Round plug connector, Series CON-RD

- Socket M8x1 4-pin A-coded straight 180°
- open cable ends
- with cable
- UL (Underwriters Laboratories)
- unshielded



Ambient temperature min./max.	-40 ... 85 °C
Operational voltage	48 V AC/DC
Protection class	IP67
Wire cross-section	0.25 mm ²
Weight	See table below

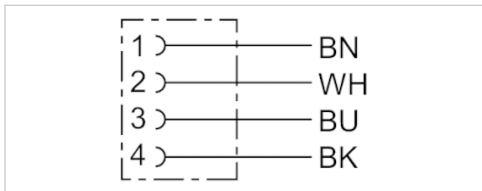

Technical data

Part No.	Max. current	Number of wires	Cable-Ø	Cable length	Certification	Weight
1834484144	4 A	4	4.5 mm	3 m	UL (Underwriters Laboratories)	0.087 kg
1834484146	4 A	4	4.5 mm	5 m	UL (Underwriters Laboratories)	0.14 kg

Technical information

The specified protection class is only valid in assembled and tested state.

Technical information

Material	
Housing	Polyurethane
Cable sheath	Polyurethane

Dimensions

Dimensions

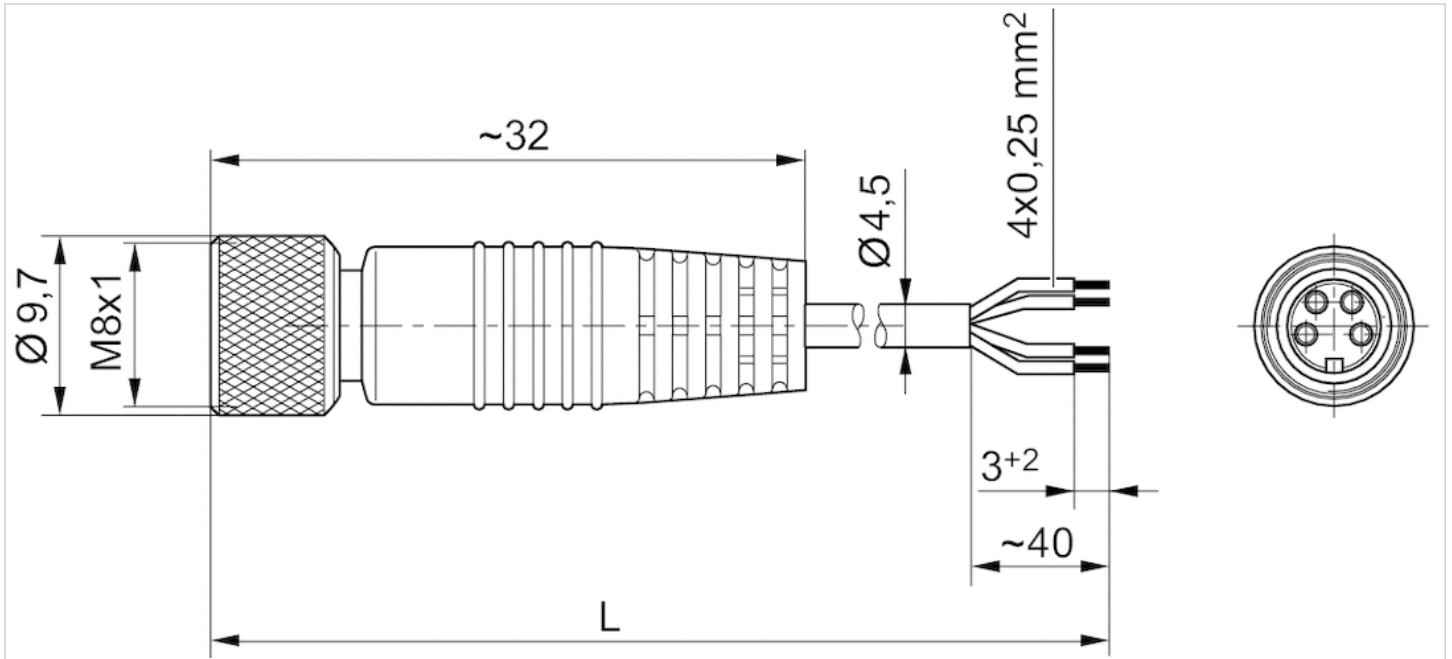

L = length

Pin assignments

Pin assignment, socket

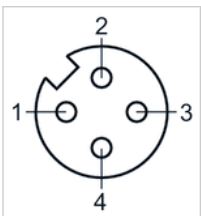

- (1) BN=brown
- (2) WH=white
- (3) BU=blue
- (4) BK=black

Round plug connector, Series CON-RD

- Socket M8x1 4-pin A-coded angled 90°
- open cable ends
- with cable
- unshielded



Ambient temperature min./max.	-25 ... 85 °C
Operational voltage	48 V AC/DC
Protection class	IP67
Wire cross-section	0.25 mm ²
Weight	See table below

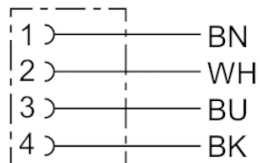

Technical data

Part No.	Max. current	Number of wires	Cable-Ø	Cable length	Weight
1834484145	4 A	4	4.5 mm	3 m	0.086 kg
1834484147	4 A	4	4.5 mm	5 m	0.141 kg

Technical information

The specified protection class is only valid in assembled and tested state.

Technical information

Material	
Housing	Polyurethane
Cable sheath	Polyurethane

Dimensions

Dimensions

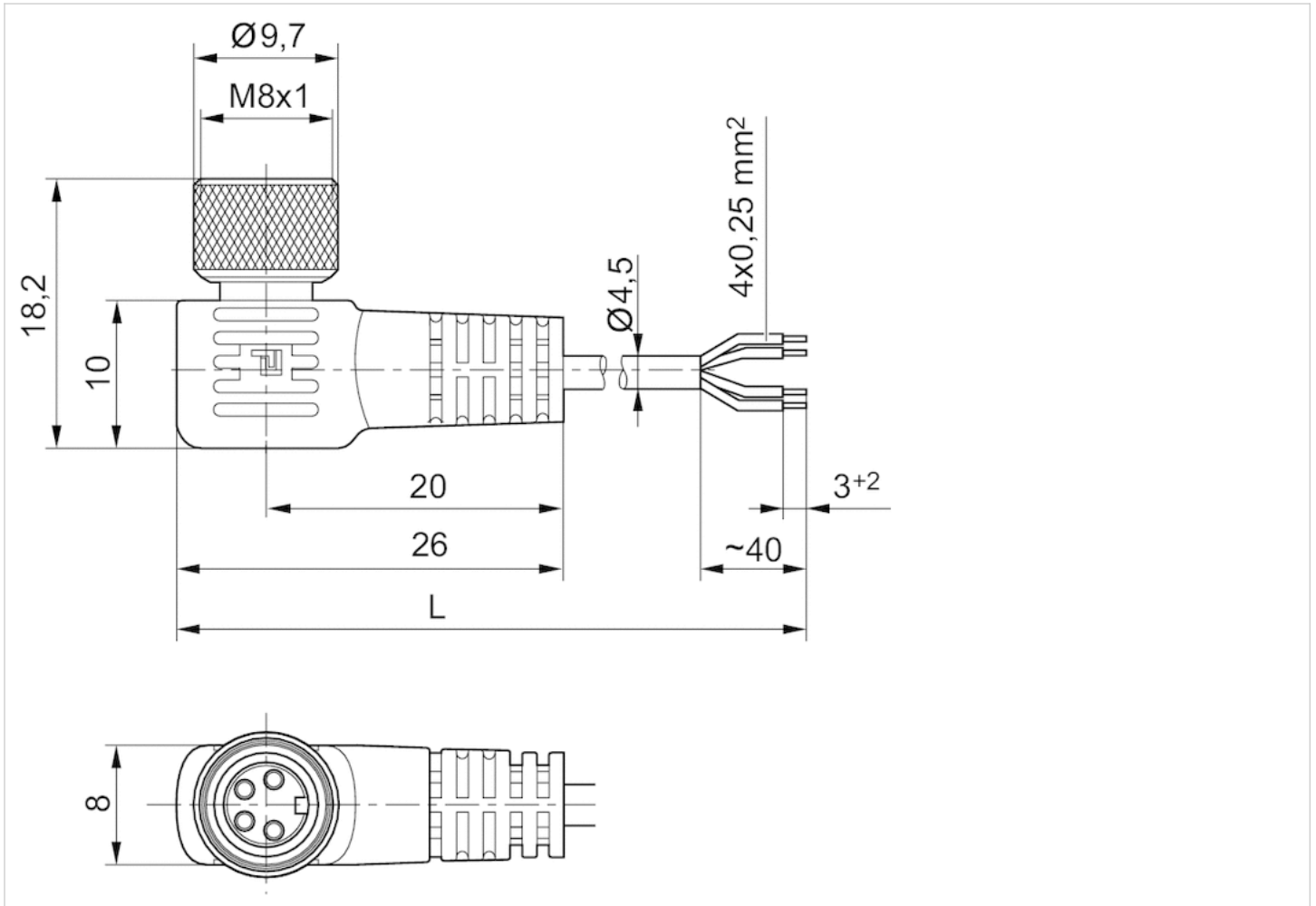

L = length

Pin assignments

Pin assignment, socket

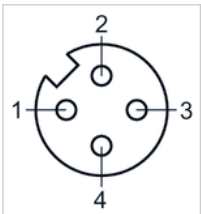

- (1) BN=brown
- (2) WH=white
- (3) BU=blue
- (4) BK=black

Round plug connector, Series CON-RD

- Socket, M8x1, 3-pin, A-coded, straight, 180°
- UL (Underwriters Laboratories)
- unshielded



Connection type	Soldering
Ambient temperature min./max.	-25 ... 80 °C
Operational voltage	48 V AC/DC
Protection class	IP67
Weight	0.009 kg

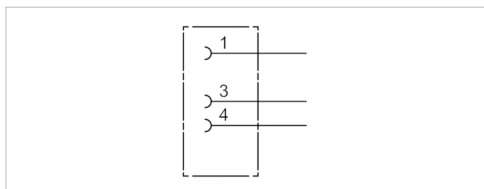

Technical data

Part No.	Max. current	suitable cable-Ø min./max
1834484173	4 A	3.5 / 5 mm

Technical information

The specified protection class is only valid in assembled and tested state.

Technical information

Material	
Housing	Polyamide

Dimensions

Dimensions

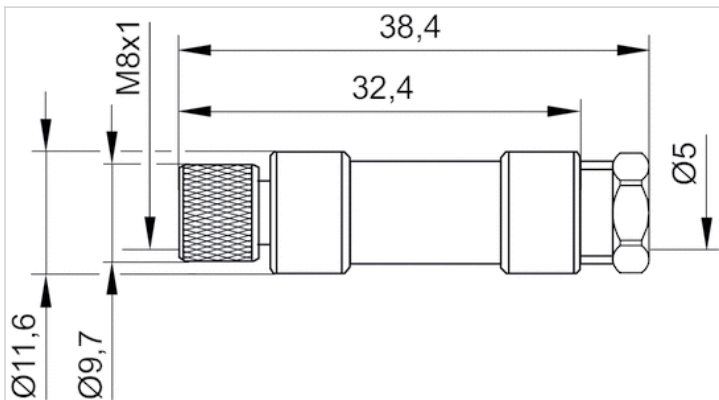

Pin assignments

Pin assignment, socket

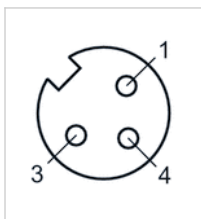

Round plug connector, Series CON-RD

- Socket, M8x1, 3-pin, A-coded, angled, 90°
- UL (Underwriters Laboratories)
- unshielded



Connection type	Soldering
Ambient temperature min./max.	-40 ... 85 °C
Operational voltage	48 V AC/DC
Protection class	IP67
Weight	0.01 kg

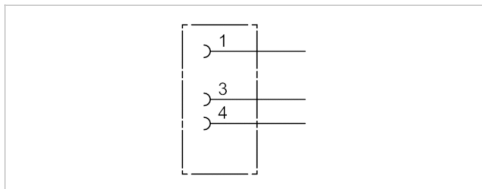

Technical data

Part No.	Max. current	Contact assignment	suitable cable-Ø min./max
1834484174	4 A	3	3.5 / 5 mm

Technical information

The specified protection class is only valid in assembled and tested state.

Technical information

Material	
Housing	Polyamide

Dimensions

Dimensions

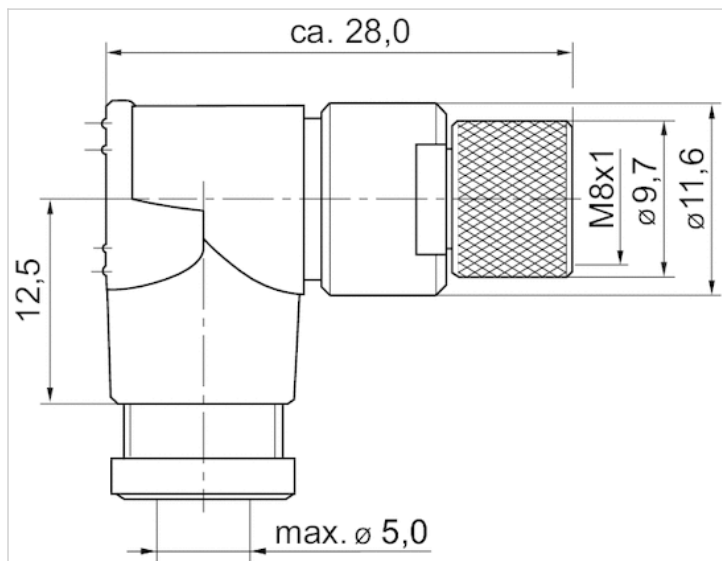

Pin assignments

Pin assignment, socket

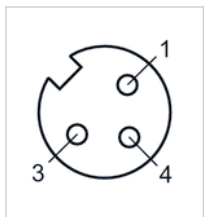

Manifold strip

- for TC15



Nominal flow Q _n	1500 l/min
Ambient temperature min./max.	-10 ... 50 °C
Medium	Compressed air
Weight	See table below

Technical data

Part No.	Type	Number of valve positions	Weight
R422000942	Manifold strip	2	0.218 kg
R422000943	Manifold strip	3	0.282 kg
R422000944	Manifold strip	4	0.346 kg
R422000945	Manifold strip	5	0.408 kg
R422000946	Manifold strip	6	0.474 kg
R412012680	Manifold strip	8	0.598 kg
R412012681	Manifold strip	10	0.724 kg
R412012682	Manifold strip	12	0.851 kg
R422000947	Mounting kit	-	0.239 kg
R422000938	Blanking plate	-	0.079 kg

mounting kit for 6 valves, delivery incl. seals and mounting screws, Blanking plates, 5 pcs., delivery incl. seals and mounting screws

Technical information

The min. control pressure must be adhered to, since otherwise faulty switching and valve failure may result!

The pressure dew point must be at least 15 °C under ambient and medium temperature and may not exceed 3 °C .

The oil content of compressed air must remain constant during the life cycle.

Use only the approved oils from AVENTICS. Further information can be found in the "Technical information" document (available in the MediaCentre).

Technical information

Material	
Base plate	Aluminum
Seal	Acrylonitrile butadiene rubber

Dimensions

Dimensions

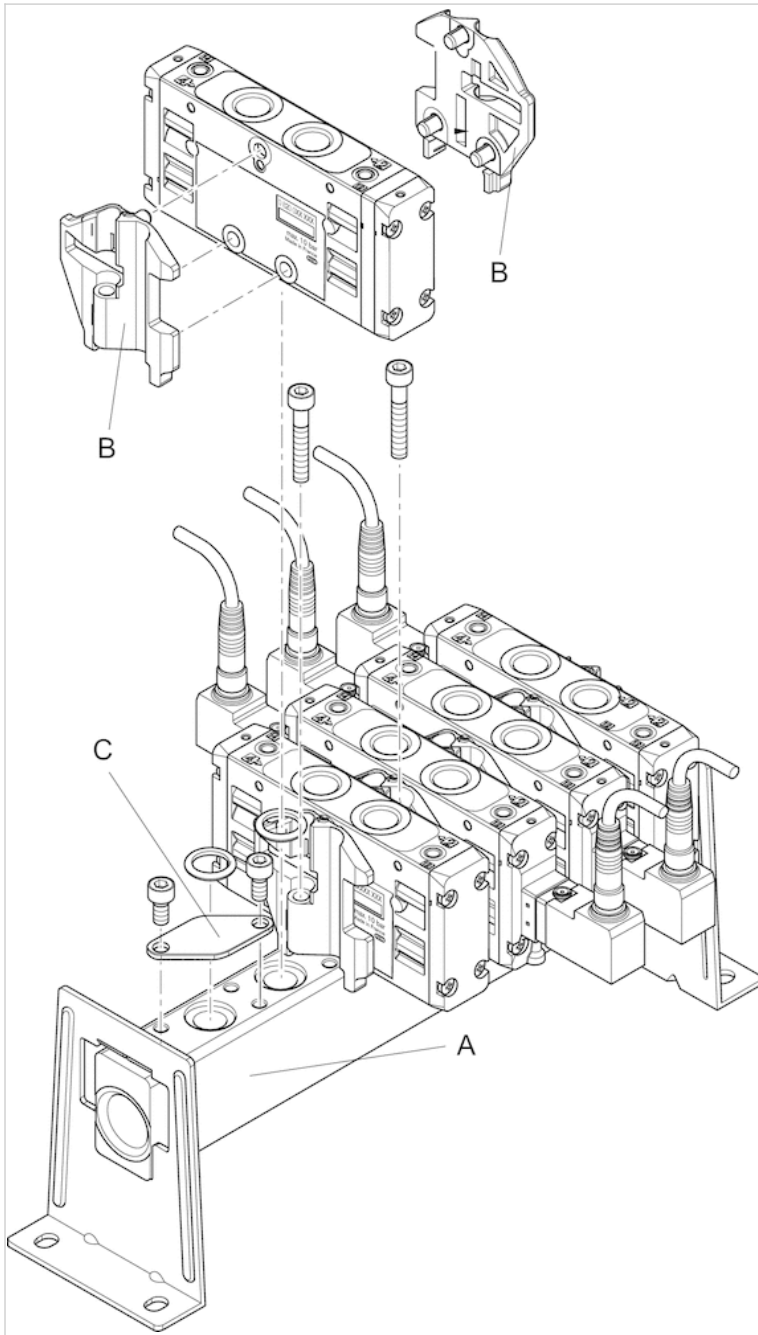

The following must be ordered to mount the valves: manifold strip A and mounting kit B
C = Blanking plate

Dimensions

Part No.	
R422000942	A
R422000943	A
R422000944	A
R422000945	A
R422000946	A

Part No.	
R412012680	A
R412012681	A
R412012682	A
R422000947	B
R422000938	C

Dimensions

Dimensions, P-strip with mounting bracket

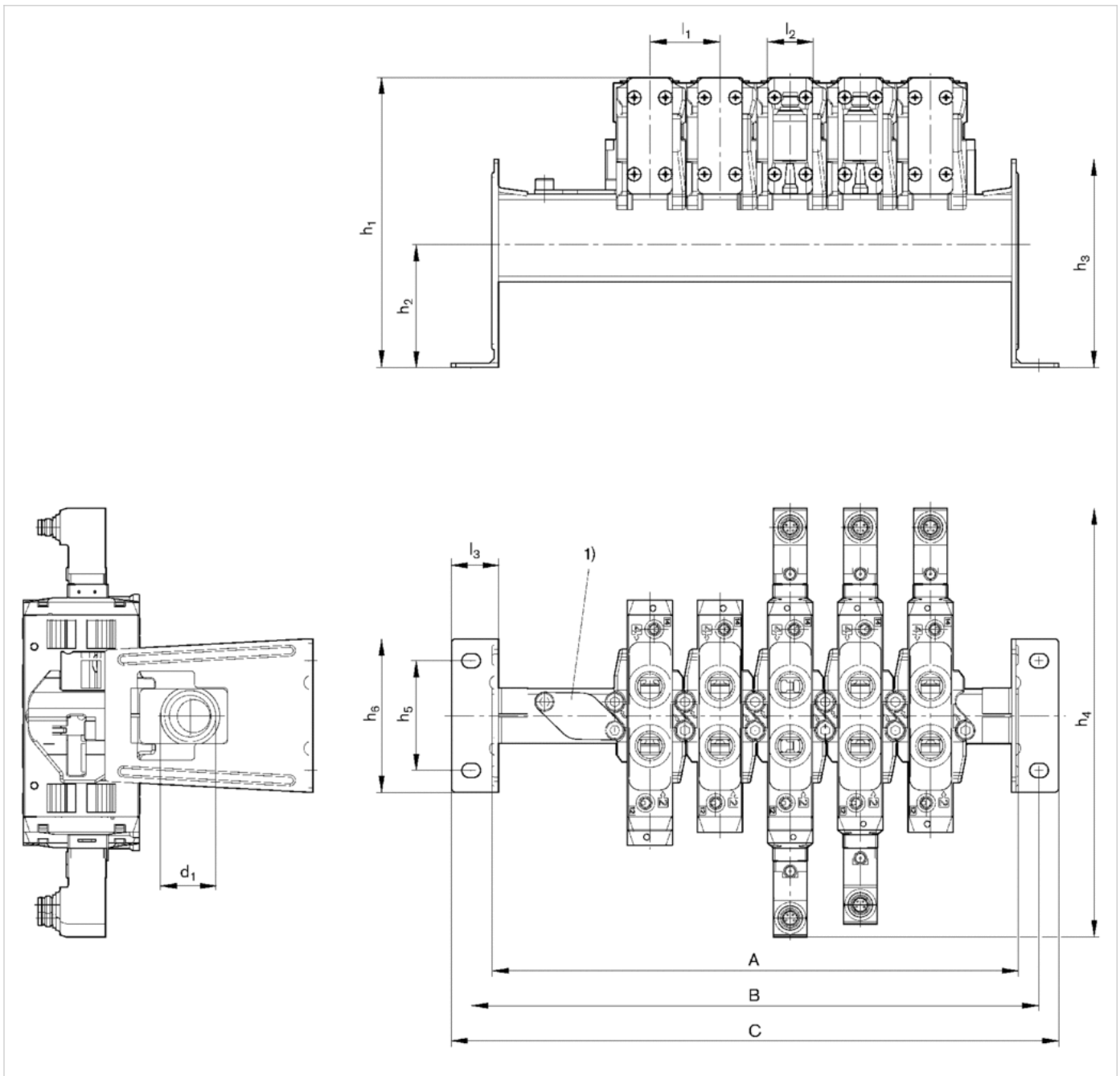

Dimensions

Part No.	n	A	B	C	d1	h1	h2	h3	h4	h5	h6	l1	l2	l3
R422000942	2	112	131	149	G 1/2	132,2	56	95	195,6	50	70	32	21	21,5
R422000943	3	144	163	181	G 1/2	132,2	56	95	195,6	50	70	32	21	21,5
R422000944	4	176	195	213	G 1/2	132,2	56	95	195,6	50	70	32	21	21,5
R422000945	5	208	227	245	G 1/2	132,2	56	95	195,6	50	70	32	21	21,5
R422000946	6	240	259	277	G 1/2	132,2	56	95	195,6	50	70	32	21	21,5
R412012680	8	304	323	341	G 1/2	132,2	56	95	195,6	50	70	32	21	21,5
R412012681	10	368	387	405	G 1/2	132,2	56	95	195,6	50	70	32	21	21,5
R412012682	12	432	451	469	G 1/2	132,2	56	95	195,6	50	70	32	21	21,5
-	-	-	-	-	-	-	-	-	-	-	-	-	-	-
-	-	-	-	-	-	-	-	-	-	-	-	-	-	-

n = number of valve positions

Dimensions

Dimensions

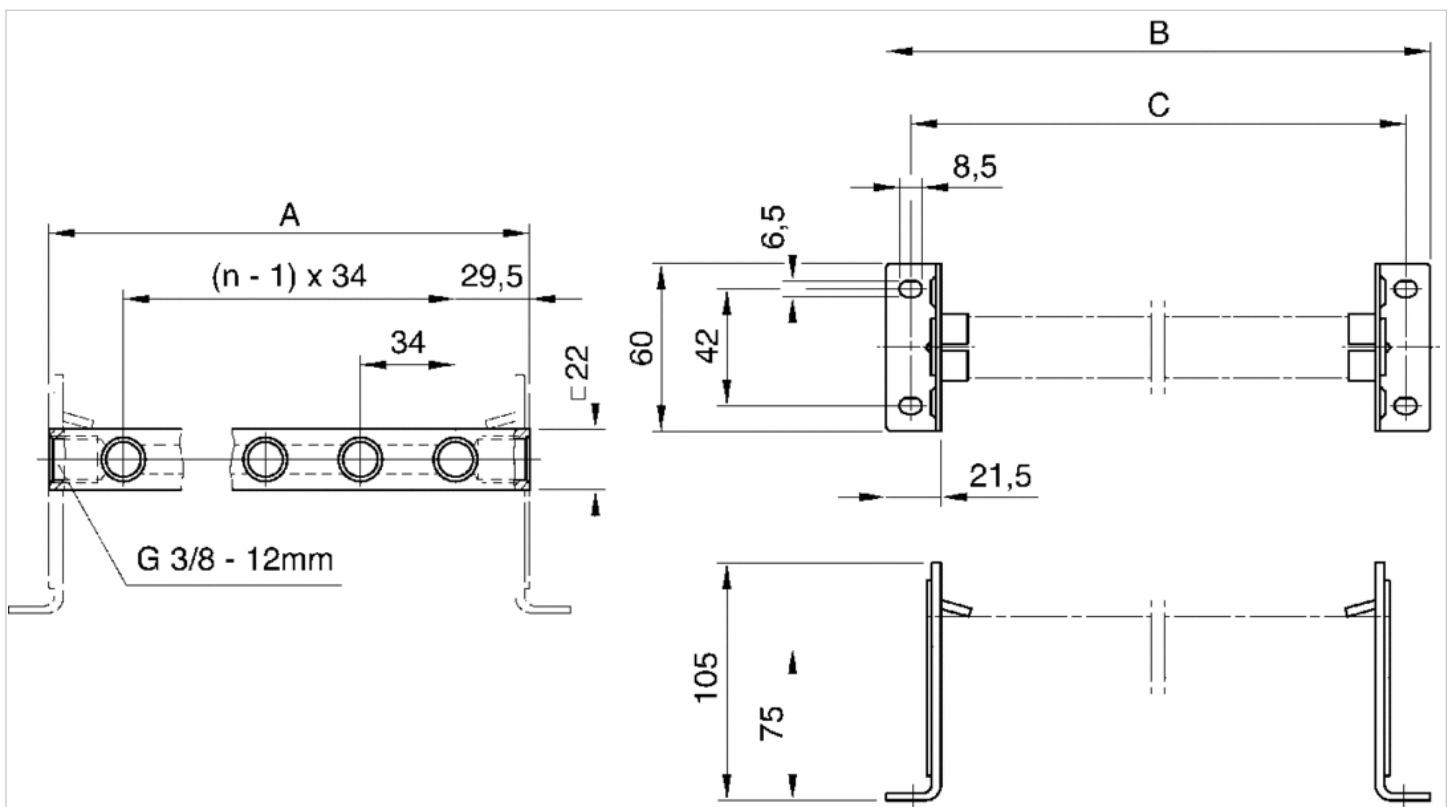

Dimensions, P-strip with mounting bracket

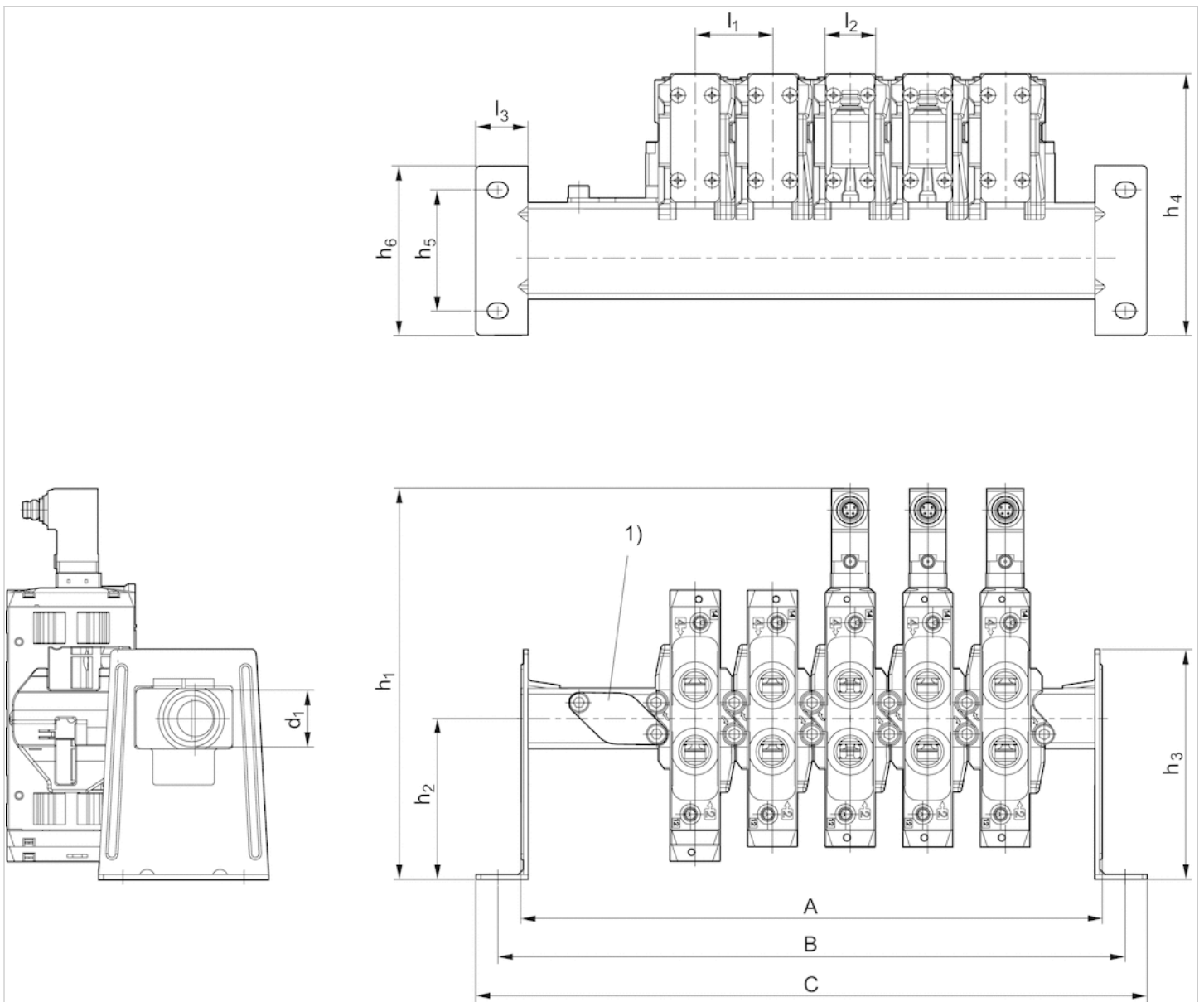

Dimensions

Part No.	n	A	B	C	d1	h1	h2	h3	h4	h5	h6	l1	l2	l3
R422000942	2	112	131	149	G 1/2	161,3	66,5	95	108	50	70	32	21	21,5
R422000943	3	144	163	181	G 1/2	161,3	66,5	95	108	50	70	32	21	21,5
R422000944	4	176	195	213	G 1/2	161,3	66,5	95	108	50	70	32	21	21,5
R422000945	5	208	227	245	G 1/2	161,3	66,5	95	108	50	70	32	21	21,5
R422000946	6	240	259	277	G 1/2	161,3	66,5	95	108	50	70	32	21	21,5
R412012680	8	304	323	341	G 1/2	161,3	66,5	95	108	50	70	32	21	21,5
R412012681	10	368	387	405	G 1/2	161,3	66,5	95	108	50	70	32	21	21,5
R412012682	12	432	451	469	G 1/2	161,3	66,5	95	108	50	70	32	21	21,5
-	-	-	-	-	-	-	-	-	-	-	-	-	-	-
-	-	-	-	-	-	-	-	-	-	-	-	-	-	-

n = number of valve positions

Dimensions

Dimensions, p-strip with support bracket

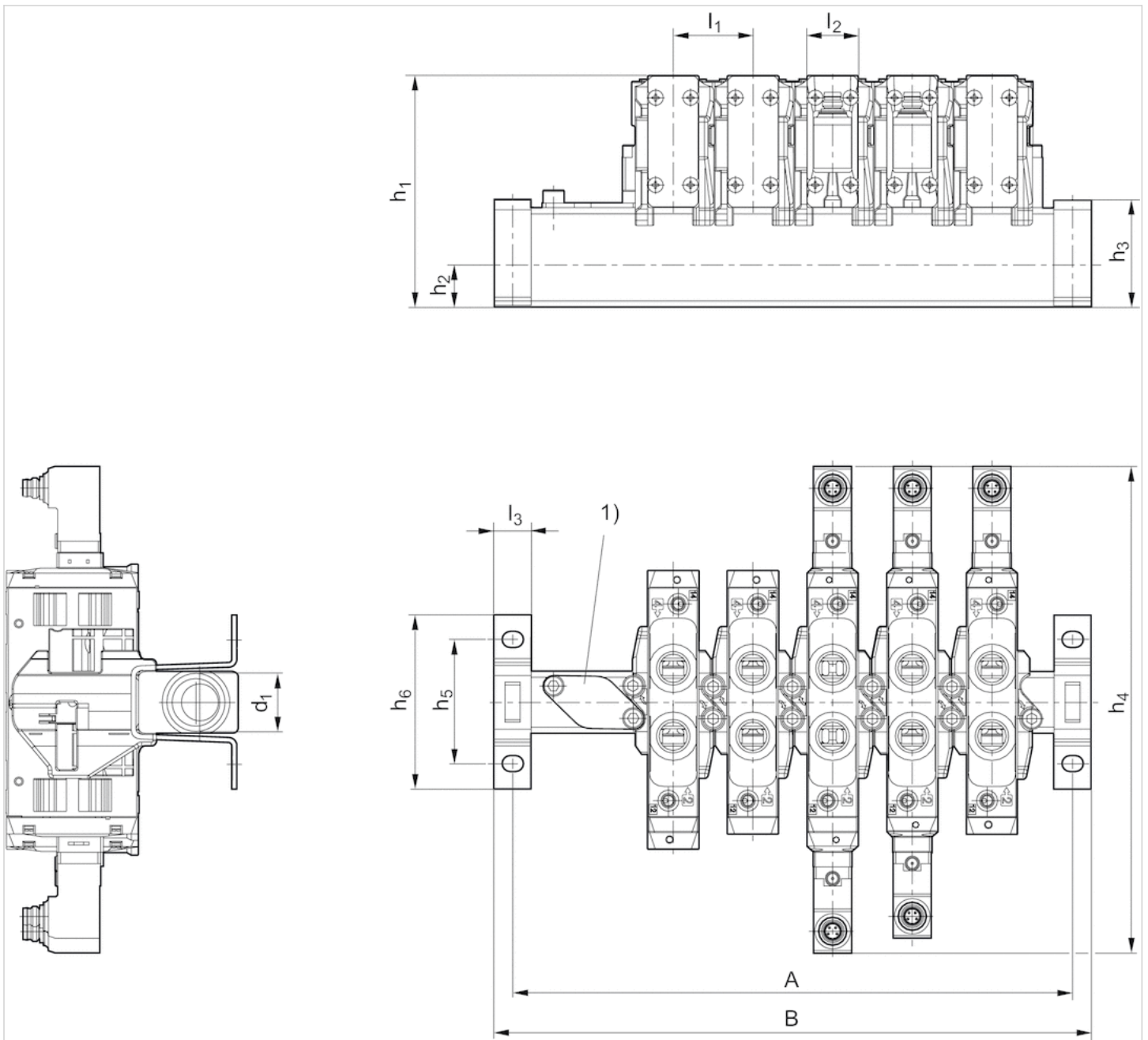

Dimensions

Part No.	n	A	B	d1	h1	h2	h3	h4	h5	h6	l1	l2	l3
R422000942	2	97	112	G 1/2	93,2	17	43,1	195,6	50	70	32	21	15
R422000943	3	129	144	G 1/2	93,2	17	43,1	195,6	50	70	32	21	15
R422000944	4	161	176	G 1/2	93,2	17	43,1	195,6	50	70	32	21	15
R422000945	5	193	208	G 1/2	93,2	17	43,1	195,6	50	70	32	21	15
R422000946	6	225	240	G 1/2	93,2	17	43,1	195,6	50	70	32	21	15
R412012680	8	289	304	G 1/2	93,2	17	43,1	195,6	50	70	32	21	15
R412012681	10	353	368	G 1/2	93,2	17	43,1	195,6	50	70	32	21	15
R412012682	12	417	432	G 1/2	93,2	17	43,1	195,6	50	70	32	21	15

Part No.	n	A	B	d1	h1	h2	h3	h4	h5	h6	l1	l2	l3
-	-	-	-	-	-	-	-	-	-	-	-	-	-
-	-	-	-	-	-	-	-	-	-	-	-	-	-

n = number of valve positions

Dimensions

Dimensions

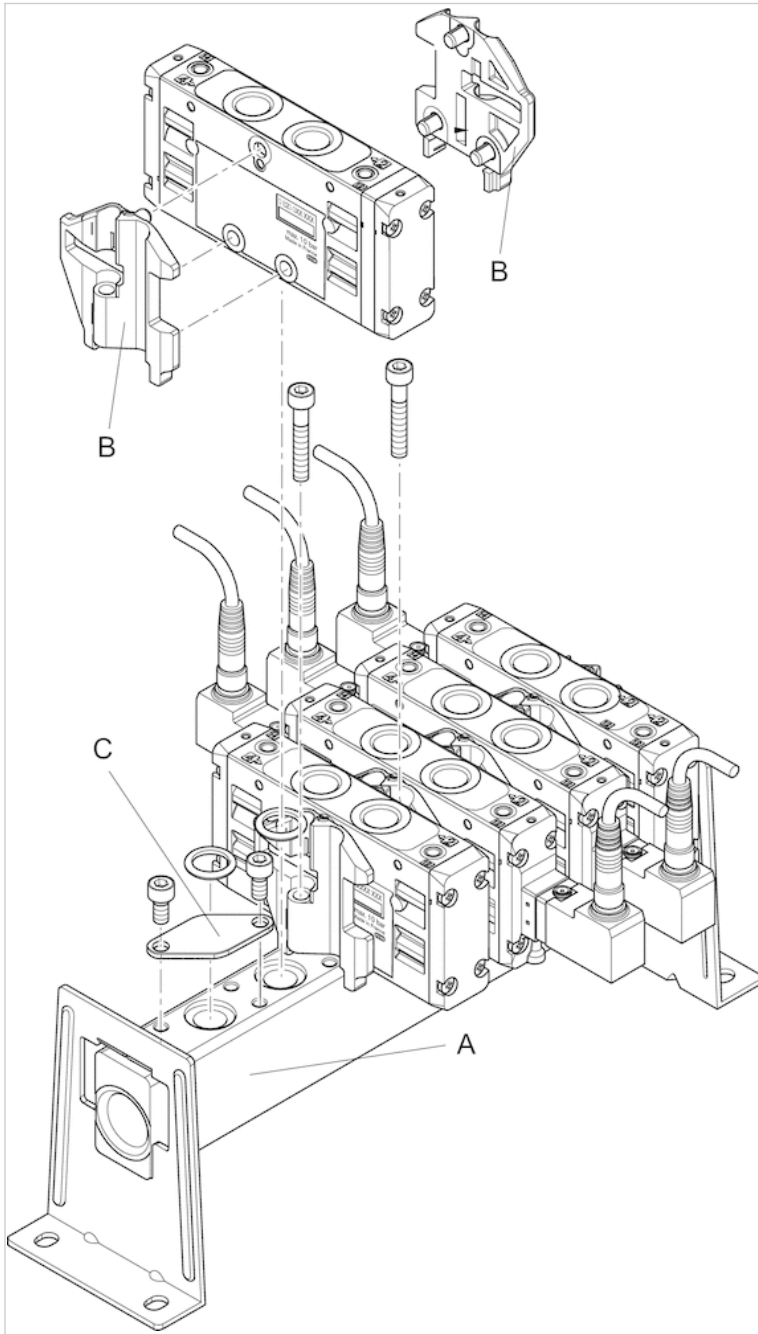

The following must be ordered to mount the valves: manifold strip A and mounting kit B
 C = Blanking plate

Dimensions

Part No.	
R422000942	A
R422000943	A
R422000944	A
R422000945	A
R422000946	A
R412012680	A
R412012681	A
R412012682	A
R422000947	B
R422000938	C

Dimensions

Dimensions

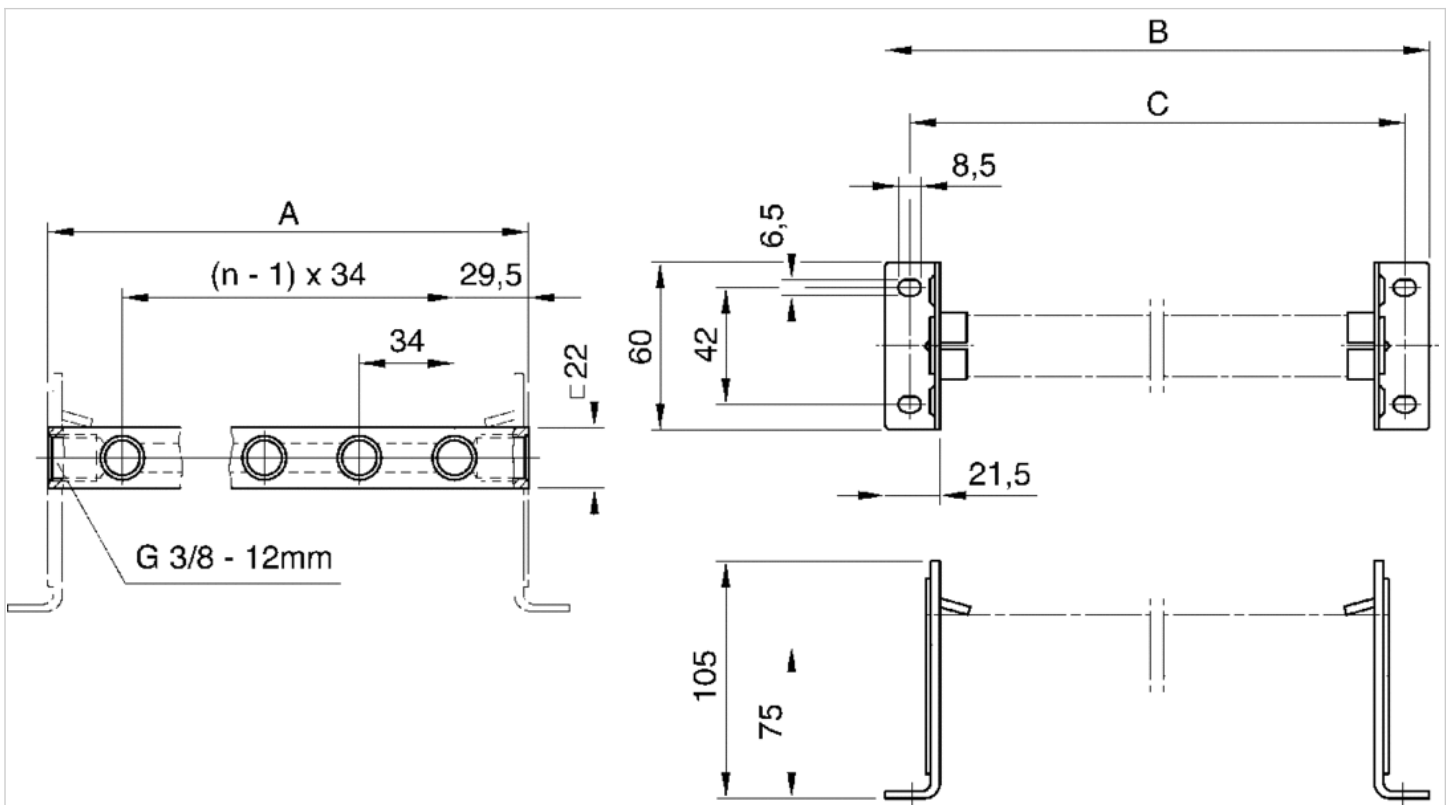

Dimensions, P-strip with mounting bracket

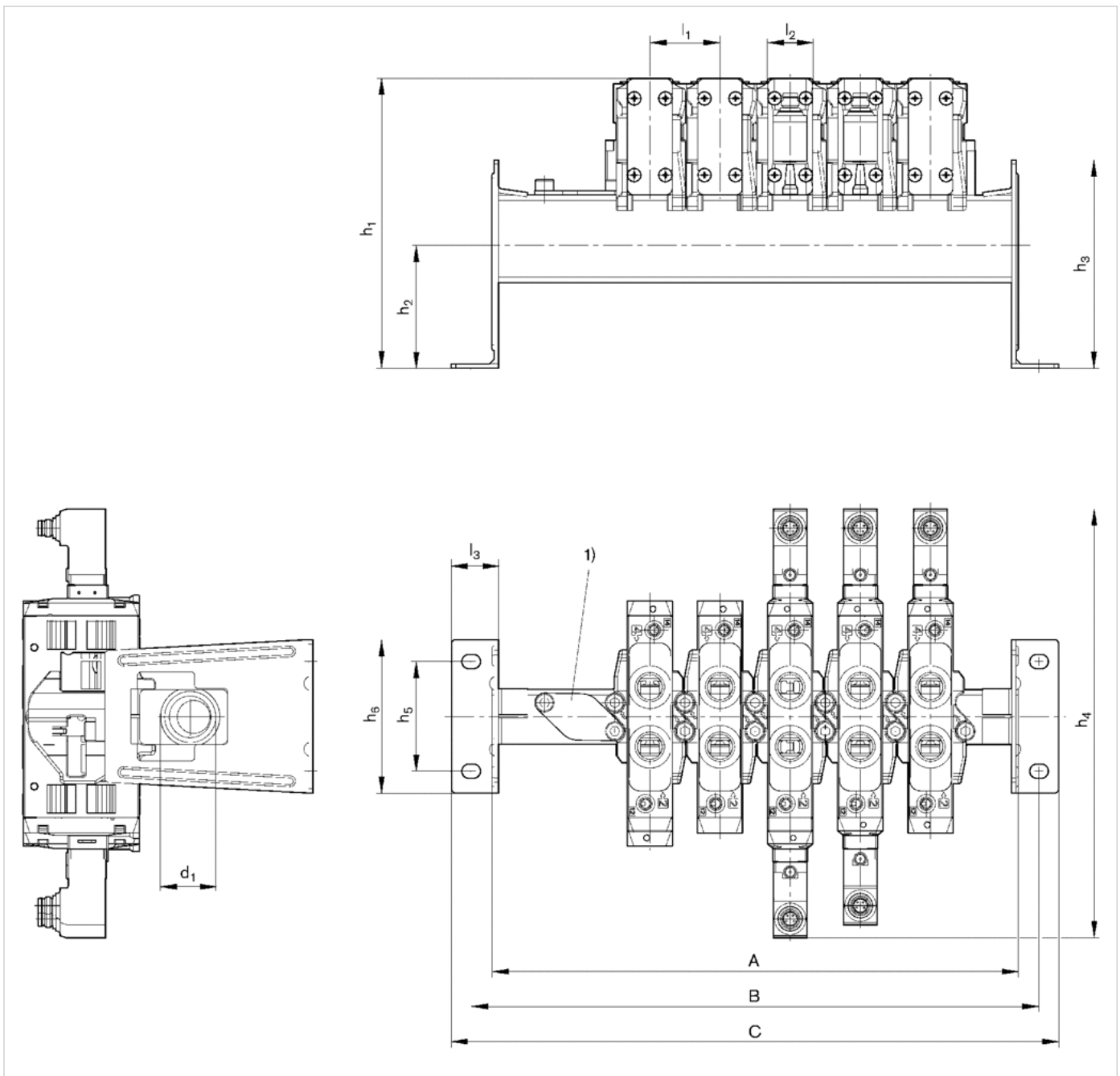

Dimensions

Part No.	n	A	B	C	d1	h1	h2	h3	h4	h5	h6	l1	l2	l3
R422000942	2	112	131	149	G 1/2	132,2	56	95	195,6	50	70	32	21	21,5
R422000943	3	144	163	181	G 1/2	132,2	56	95	195,6	50	70	32	21	21,5
R422000944	4	176	195	213	G 1/2	132,2	56	95	195,6	50	70	32	21	21,5
R422000945	5	208	227	245	G 1/2	132,2	56	95	195,6	50	70	32	21	21,5
R422000946	6	240	259	277	G 1/2	132,2	56	95	195,6	50	70	32	21	21,5
R412012680	8	304	323	341	G 1/2	132,2	56	95	195,6	50	70	32	21	21,5
R412012681	10	368	387	405	G 1/2	132,2	56	95	195,6	50	70	32	21	21,5
R412012682	12	432	451	469	G 1/2	132,2	56	95	195,6	50	70	32	21	21,5
-	-	-	-	-	-	-	-	-	-	-	-	-	-	-
-	-	-	-	-	-	-	-	-	-	-	-	-	-	-

n = number of valve positions

Dimensions

Dimensions, P-strip with mounting bracket

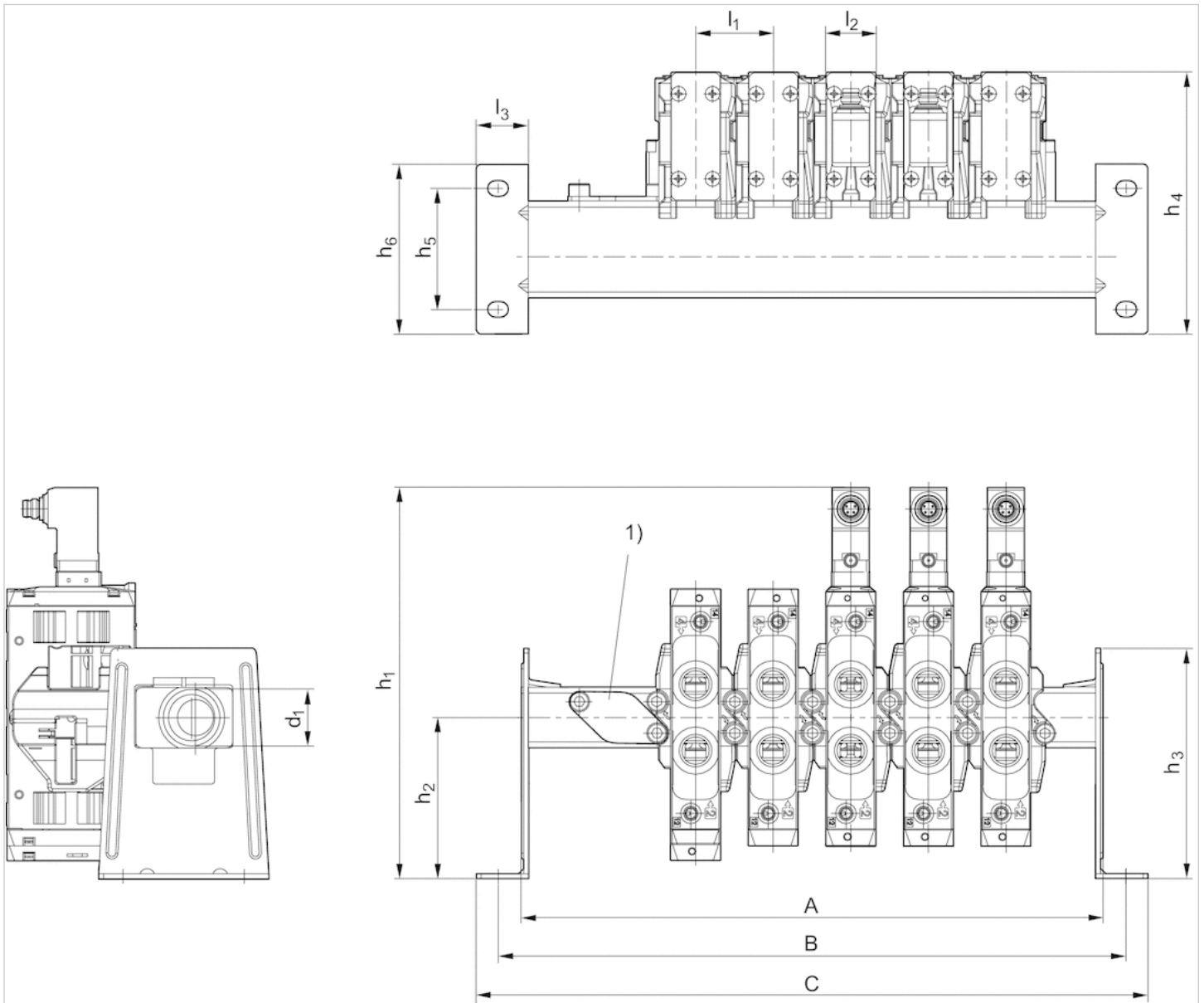

Dimensions

Part No.	n	A	B	C	d1	h1	h2	h3	h4	h5	h6	l1	l2	l3
R422000942	2	112	131	149	G 1/2	161,3	66,5	95	108	50	70	32	21	21,5
R422000943	3	144	163	181	G 1/2	161,3	66,5	95	108	50	70	32	21	21,5
R422000944	4	176	195	213	G 1/2	161,3	66,5	95	108	50	70	32	21	21,5
R422000945	5	208	227	245	G 1/2	161,3	66,5	95	108	50	70	32	21	21,5
R422000946	6	240	259	277	G 1/2	161,3	66,5	95	108	50	70	32	21	21,5
R412012680	8	304	323	341	G 1/2	161,3	66,5	95	108	50	70	32	21	21,5
R412012681	10	368	387	405	G 1/2	161,3	66,5	95	108	50	70	32	21	21,5
R412012682	12	432	451	469	G 1/2	161,3	66,5	95	108	50	70	32	21	21,5
-	-	-	-	-	-	-	-	-	-	-	-	-	-	-

Part No.	n	A	B	C	d1	h1	h2	h3	h4	h5	h6	l1	l2	l3
-	-	-	-	-	-	-	-	-	-	-	-	-	-	-

n = number of valve positions

Dimensions

Dimensions, p-strip with support bracket

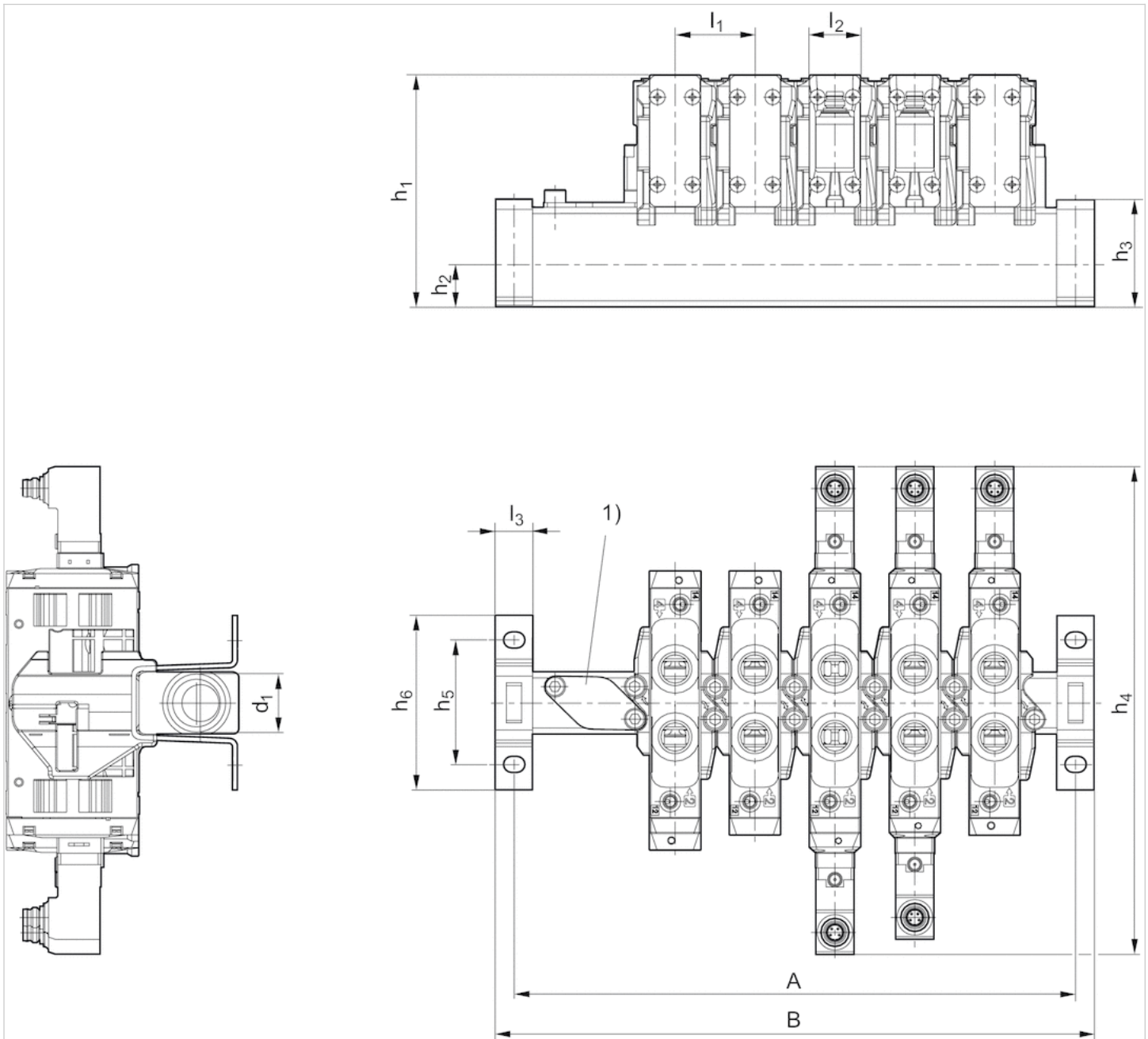

Dimensions

Part No.	n	A	B	d1	h1	h2	h3	h4	h5	h6	l1	l2	l3
R422000942	2	97	112	G 1/2	93,2	17	43,1	195,6	50	70	32	21	15
R422000943	3	129	144	G 1/2	93,2	17	43,1	195,6	50	70	32	21	15
R422000944	4	161	176	G 1/2	93,2	17	43,1	195,6	50	70	32	21	15
R422000945	5	193	208	G 1/2	93,2	17	43,1	195,6	50	70	32	21	15

Part No.	n	A	B	d1	h1	h2	h3	h4	h5	h6	l1	l2	l3
R422000946	6	225	240	G 1/2	93,2	17	43,1	195,6	50	70	32	21	15
R412012680	8	289	304	G 1/2	93,2	17	43,1	195,6	50	70	32	21	15
R412012681	10	353	368	G 1/2	93,2	17	43,1	195,6	50	70	32	21	15
R412012682	12	417	432	G 1/2	93,2	17	43,1	195,6	50	70	32	21	15
-	-	-	-	-	-	-	-	-	-	-	-	-	-
-	-	-	-	-	-	-	-	-	-	-	-	-	-

n = number of valve positions

Mounting clip



Weight

0.033 kg

Technical data

Part No.	Type	Suitable for	Delivery unit
1821332051	Mounting clip	Manifold strip	2 piece

Dimensions

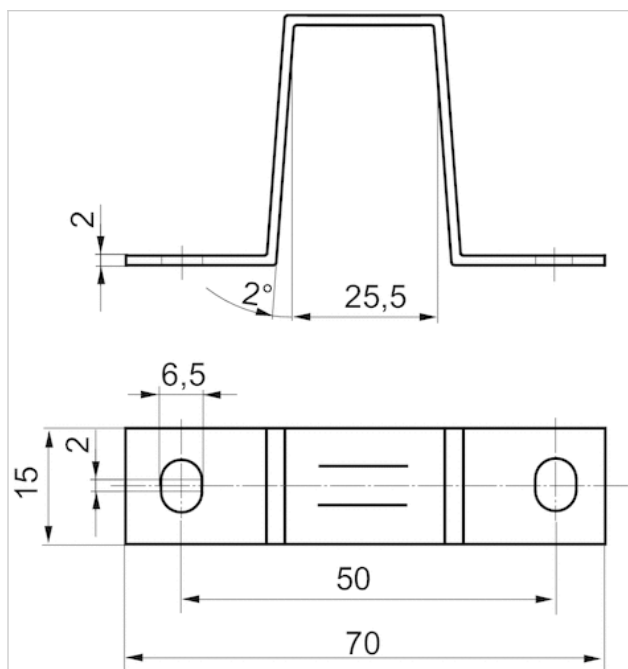

Mounting bracket



Weight

0.1 kg

Technical data

Part No.	Type	Suitable for	Delivery unit
1821332050	Mounting bracket	Manifold strip	1 piece

2 mountings are required per manifold strip.

Dimensions

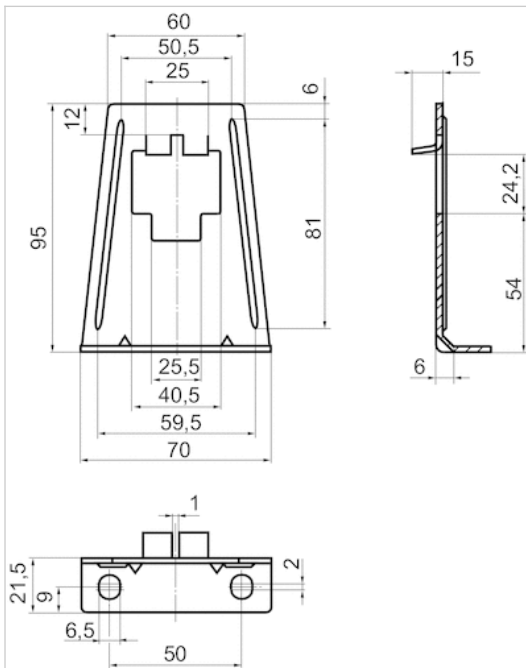

Mounting kit for DIN rails DIN

- standard 26 mm

- type A



Weight

0.014 kg

Technical data

Part No.	Type	Accessory type	Frame size	Delivery unit
1821398007	Mounting kit for DIN rails EN 60715, 35x15	type A	26 mm	1 piece

Dimensions

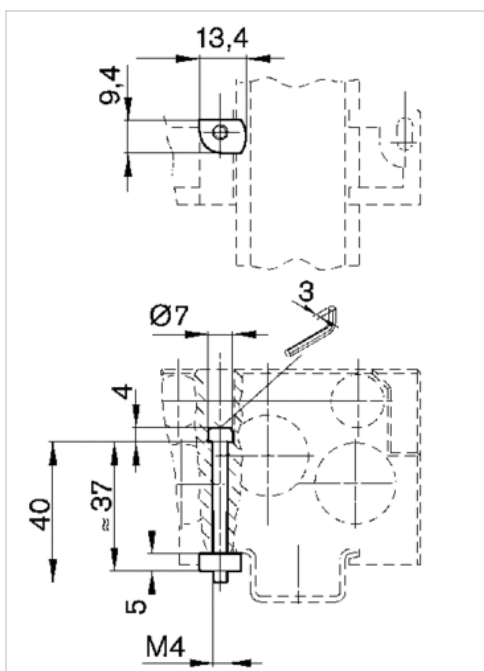

Efficient pneumatic solutions, our program: cylinders and drives, valves and valve systems, air supply management



Visit us: Emerson.com/Aventics

Your local contact: Emerson.com/contactus



Emerson.com



[Facebook.com/EmersonAutomationSolutions](https://www.facebook.com/EmersonAutomationSolutions)



[LinkedIn.com/company/Emerson-Automation-Solutions](https://www.linkedin.com/company/Emerson-Automation-Solutions)



[Twitter.com/EMR_Automation](https://twitter.com/EMR_Automation)

An example configuration is depicted on the title page. The delivered product may thus vary from that in the illustration. Subject to change. This Document, as well as the data, specifications and other information set forth in it, are the exclusive property of AVENTICS GmbH. It may not be reproduced or given to third parties without its consent. Only use the AVENTICS products shown in industrial applications. Read the product documentation completely and carefully before using the product. Observe the applicable regulations and laws of the respective country. When integrating the product into applications, note the system manufacturer's specifications for safe use of the product. The data specified only serve to describe the product. No statements concerning a certain condition or suitability for a certain application can be derived from our information. The information given does not release the user from the obligation of own judgment and verification. It must be remembered that the products are subject to a natural process of wear and aging.

The Emerson logo is a trademark and service mark of Emerson Electric Co. Brand logotype are registered trademarks of one of the Emerson family of companies. All other marks are the property of their respective owners. © 2017 Emerson Electric Co. All rights reserved.
2019-03



CONSIDER IT SOLVED™