

ATR444

Controller / Regolatore / Régulateur



Table of contents

1	Safety guidelines.....	7
1.1	Organization of safety notices.....	7
1.2	Safety Precautions.....	7
1.3	Precautions for safe use.....	8
1.4	Environmental policy / WEEE.....	8
2	Model Identification.....	9
3	Technical Data.....	9
3.1	General Features.....	9
3.2	Hardware Features.....	9
3.3	Software Features.....	10
3.4	Programming mode.....	10
4	Dimensions and Installation.....	10
5	Electrical wirings.....	11
5.1	Wiring diagram.....	11
5.1.a	Power Supply.....	11
5.1.b	Analogue Input AI1.....	11
5.1.c	Analogue Input AI2 (only ATR444-2xABC-x).....	12
5.1.d	CT1 input.....	12
5.1.e	CT2 input (only ATR444-22ABC).....	12
5.1.f	Digital inputs.....	13
5.1.g	Serial input (only ATR444-xxxxx-T).....	13
5.1.h	Digital outputs.....	13
5.1.i	AO1 Analogue output.....	13
5.1.j	AO2 Analogue output (only ATR444-24ABC-T).....	13
5.1.k	Relays output Q1 and Q2.....	14
5.1.l	Relays output Q3, Q4 and Q5 (where required).....	14
6	Numeric Indicators (Display).....	14
6.1	Meaning of Status Lights (Led).....	15
6.2	Keys.....	15
7	Dual input mode.....	15
7.1	Selection of process value related to the command output and to the alarms.....	16
7.2	Remote setpoint by analogue input.....	16
7.3	Remote setpoint by serial input.....	16
8	Controller Functions.....	17
8.1	Modification of main and alarm setpoint value.....	17
8.2	Automatic Tune.....	17
8.3	Manual Tune.....	17
8.4	Tuning once.....	17
8.5	Synchronized tuning.....	18
8.6	Digital input functions.....	18
8.7	Automatic / Manual regulation for % output control.....	19
8.8	Heater Break Alarm on CT (Current Transformer).....	20
8.9	Dual Action (Heating-Cooling).....	20
8.10	LATCH ON Function.....	21
8.11	Soft-Start Function.....	22
8.12	Retransmission function on analogue output.....	22
8.13	Timer functions.....	22
9	Programmer (1 cycle, 12 steps).....	23
9.1	Programming (or modifying) cycle data.....	23
9.2	Cycle start.....	24
9.3	Recovery of interrupted cycle.....	24
9.3.1	Recovery with automatic gradient.....	24
9.3.2	Recovery with recovery gradient.....	24
9.4	Waiting step end.....	25
10	Serial communication.....	25
10.1	Serial compatibility with ATR401-22ABC-T.....	31
11	Reading and configuration through NFC.....	34

11.1	Configuration through memory card	35
11.2	Memory card creation/update	35
11.3	Configuration loading from memory card	35
12	Loading default values	35
13	Access configuration	36
13.1	Parameters list functioning	36
14	Table of configuration parameters	37
15	Alarm intervention modes	91
15.a	Absolute or threshold alarm active over (par. 135 $RL_IF = Ab.uPA$)	91
15.b	Absolute or threshold alarm active below (par. 135 $RL_IF = Ab.uPA$)	91
15.c	Absolute or threshold alarm referred to command setpoint active over (par. 135 $RL_IF = Ab.c.uA$)	92
15.d	Absolute or threshold alarm referred to command setpoint active below (par. 135 $RL_IF = Ab.c.LA$)	92
15.e	Band alarm (par. 135 $RL_IF = bAnd$)	92
15.f	Asymmetric band alarm (par. 135 $RL_IF = A.bAnd$)	92
15.g	Upper deviation alarm (par. 135 $RL_IF = uP.dEu$)	93
15.h	Lower deviation alarm (par. 135 $RL_IF = Lo.dEu$)	93
15.1	Alarms label	93
16	Table of Anomaly Signals	94

Indice degli argomenti

1	Norme di sicurezza	103
1.1	Organizzazione delle note di sicurezza	103
1.2	Note di sicurezza	103
1.3	Precauzioni per l'uso sicuro	104
1.4	Tutela ambientale e smaltimento dei rifiuti / Direttiva WEEE	104
2	Identificazione di modello	105
3	Dati tecnici	105
3.1	Caratteristiche generali	105
3.2	Caratteristiche Hardware	105
3.3	Caratteristiche software	106
3.4	Modalità di programmazione	106
4	Dimensioni e installazione	106
5	Collegamenti elettrici	107
5.1	Schema di collegamento	107
5.1.a	Alimentazione	107
5.1.b	Ingresso analogico AI1	107
5.1.c	Ingresso analogico AI2 (solo ATR444-2xABC-x)	108
5.1.d	Ingresso CT1	108
5.1.e	Ingresso CT2 (solo ATR444-22ABC)	109
5.1.f	Ingressi digitali	109
5.1.g	Ingresso seriale (solo ATR444-xxxx-T)	109
5.1.h	Uscite digitali	109
5.1.i	Uscita analogica AO1	109
5.1.j	Uscita analogica AO2 (solo ATR444-24ABC-T)	110
5.1.k	Uscite relè Q1 e Q2	110
5.1.l	Uscite relè Q3, Q4 e Q5 (dove previsti)	110
6	Funzione dei visualizzatori e tasti	110
6.1	Significato delle spie di stato (Led)	111
6.2	Tasti	111
7	Modalità doppio ingresso	111
7.1	Selezione grandezza correlata al comando e agli allarmi	112
7.2	Setpoint remoto da ingresso analogico	112
7.3	Setpoint remoto da ingresso seriale	112
8	Funzioni del regolatore	113
8.1	Modifica valore setpoint principale e di allarme	113
8.2	Tuning automatico	113
8.3	Tuning manuale	113

8.4	Tuning once	113
8.5	Tuning sincronizzato	114
8.6	Funzioni da Ingresso digitale	114
8.7	Regolazione automatico / manuale del controllo % uscita	115
8.8	Heater Break Alarm su CT (Trasformatore Amperometrico)	116
8.9	Funzionamento in doppia azione (caldo-freddo)	116
8.10	Funzione LATCH ON	117
8.11	Funzione Soft-Start	118
8.12	Funzione ritrasmissione su uscita analogica	118
8.13	Funzioni timer	118
9	Programmatore (1 ciclo, 12 spezzate)	119
9.1	Programmazione (o modifica) dati del ciclo	119
9.2	Partenza del ciclo	120
9.3	Recupero ciclo interrotto	120
9.3.1	Recupero con gradiente automatico	120
9.3.2	Recupero con gradiente di recupero	121
9.4	Attesa fine step	121
10	Comunicazione Seriale	121
10.1	Compatibilità seriale con ATR401-22ABC-T	128
11	Lettura e configurazione via NFC	130
11.1	Configurazione tramite memory card	131
11.2	Creazione / aggiornamento della memory card	131
11.3	Caricamento configurazione da memory card	131
12	Caricamento valori di default	131
13	Accesso alla configurazione	132
13.1	Funzionamento della lista parametri	132
14	Tabella parametri di configurazione	133
15	Modi d'intervento allarme	187
15.a	Allarme assoluto o allarme di soglia attivo sopra (par. 135 RL IF = Ab.uPA)	187
15.b	Allarme assoluto o allarme di soglia attivo sotto (par. 135 RL IF = Ab.uPA)	188
15.c	Allarme assoluto o allarme di soglia riferito al setpoint di comando attivo sopra (par. 135 RL IF = Ab.c.uPA)	188
15.d	Allarme assoluto o allarme di soglia riferito al setpoint di comando attivo sotto (par. 135 RL IF = Ab.c.LA)	188
15.e	Allarme di Banda (par. 135 RL IF = bArd)	188
15.f	Allarme di banda asimmetrica (par. 135 RL IF = AbArd)	189
15.g	Allarme di deviazione superiore (par. 135 RL IF = uP.dEu)	189
15.h	Allarme di deviazione inferiore (par. 135 RL IF = Lo.dEu)	189
15.1	Label allarmi	190
16	Tabella segnalazioni anomalie	190

Index des sujets

1	Consignes de sécurité	199
1.1	Organisation des avis de sécurité	199
1.2	Avis de sécurité	199
1.3	Précautions pour l'usage en toute sécurité	200
1.4	Politique environnementale / DEEE	200
2	Identification du modèle	201
3	Données techniques	201
3.1	Caractéristiques générales	201
3.2	Caractéristiques Hardware	201
3.3	Caractéristiques Software	202
3.4	Mode de programmation	202
4	Dimensions et Installation	202
4.1	Raccordements électriques	203
4.2	Plan des connexions	203
4.2.a	Alimentation	203

4.2.b	Entrée analogique AI1	203
4.2.c	Entrée analogique AI2 (seulement ATR444-2xABC-x)	204
4.2.d	Entrée CT1	204
4.2.e	Entrée CT2 (seulement ATR444-22ABC)	205
4.2.f	Entrées digitales.....	205
4.2.g	Entrée sérieelle (seulement ATR444-xxxxx-T).....	205
4.2.h	Sorties digitales	205
4.2.i	Sortie analogique AO1.....	205
4.2.j	Sortie analogique AO2 (seulement ATR444-24ABC-T)	206
4.2.k	Sortie relais Q1 et Q2	206
4.2.l	Sortie relais Q3, Q4 et Q5 (où prévu).....	206

Introduction

Controller ATR444 (48x96mm – 1/8DIN) is available in several versions featuring a variable numbers of analogue-digital I/Os. The wide range of software functions are detailed in the relevant sections below.

Programming options include App MyPixsys, relying on NFC communication and not requiring any wiring/power supply, and software tool Labsoftview via Micro-USB port.

Available also with Cycle programming function.

1 Safety guidelines

Read carefully the safety guidelines and programming instructions contained in this manual before connecting/using the device.

Disconnect power supply before proceeding to hardware settings or electrical wirings to avoid risk of electric shock, fire, malfunction.

Do not install/operate the device in environments with flammable/explosive gases.

This device has been designed and conceived for industrial environments and applications that rely on proper safety conditions in accordance with national and international regulations on labour and personal safety. Any application that might lead to serious physical damage/ life risk or involve medical life support devices should be avoided.

Device is not conceived for applications related to nuclear power plants, weapon systems, flight control, mass transportation systems.

Only qualified personnel should be allowed to use device and/or service it and only in accordance to technical data listed in this manual.

Do not dismantle/modify/repair any internal component.

Device must be installed and can operate only within the allowed environmental conditions. Overheating may lead to risk of fire and can shorten the lifecycle of electronic components.

1.1 Organization of safety notices

Safety notices in this manual are organized as follows:

Safety notice	Description
Danger!	Disregarding these safety guidelines and notices can be life-threatening.
Warning!	Disregarding these safety guidelines and notices can result in severe injury or substantial damage to property.
Information!	This information is important for preventing errors.

1.2 Safety Precautions

This product is UL listed as open type process control equipment.	Danger!
If the output relays are used past their life expectancy, contact fusing or burning may occasionally occur.	
Always consider the application conditions and use the output relays within their rated load and electrical life expectancy. The life expectancy of output relays varies considerably with the output load and switching conditions.	Danger!
Loose screws may occasionally result in fire.	
For screw terminals of relays and of power supply, tighten screws to tightening torque of 0,51 Nm. For other terminals, tightening torque is 0,19 Nm	Warning!
A malfunction in the Digital Controller may occasionally make control operations impossible or prevent alarm outputs, resulting in property damage. To maintain safety in the event of malfunction of the Digital Controller, take appropriate safety measures, such as installing a monitoring device on a separate line.	Warning!

1.3 Precautions for safe use

Be sure to observe the following precautions to prevent operation failure, malfunction, or adverse affects on the performance and functions of the product. Not doing so may occasionally result in unexpected events. Do not handle the Digital Controller in ways that exceed the ratings.

- The product is designed for indoor use only. Do not use or store the product outdoors or in any of the following places.
 - Places directly subject to heat radiated from heating equipment.
 - Places subject to splashing liquid or oil atmosphere.
 - Places subject to direct sunlight.
 - Places subject to dust or corrosive gas (in particular, sulfide gas and ammonia gas).
 - Places subject to intense temperature change.
 - Places subject to icing and condensation.
 - Places subject to vibration and large shocks.
- Installing two or more controllers in close proximity might lead to increased internal temperature and this might shorten the life cycle of electronic components. It is strongly recommended to install cooling fans or other air-conditioning devices inside the control cabinet.
- Always check the terminal names and polarity and be sure to wire properly. Do not wire the terminals that are not used.
- To avoid inductive noise, keep the controller wiring away from power cables that carry high voltages or large currents. Also, do not wire power lines together with or parallel to Digital Controller wiring. Using shielded cables and using separate conduits or ducts is recommended. Attach a surge suppressor or noise filter to peripheral devices that generate noise (in particular motors, transformers, solenoids, magnetic coils or other equipment that have an inductance component). When a noise filter is used at the power supply, first check the voltage or current, and attach the noise filter as close as possible to the Digital Controller. Allow as much space as possible between the Digital Controller and devices that generate powerful high frequencies (high-frequency welders, high-frequency sewing machines, etc.) or surge.
- A switch or circuit breaker must be provided close to device. The switch or circuit breaker must be within easy reach of the operator, and must be marked as a disconnecting means for the controller.
- The device must be protected by a fuse 1A (cl. 9.6.2).
- Wipe off any dirt from the Digital Controller with a soft dry cloth. Never use thinners, benzine, alcohol, or any cleaners that contain these or other organic solvents. Deformation or discoloration may occur.
- The number of non-volatile memory write operations is limited. Therefore, use EEprom write mode when frequently overwriting data, e.g.: through communications.

1.4 Environmental policy / WEEE

Do not dispose electric tools together with household waste material.

According to European Directive 2012/19/EU on waste electrical and electronic equipment and its implementation in accordance with national law, electric tools that have reached the end of their life must be collected separately and returned to an environmentally compatible recycling facility.

2 Model Identification

The ATR244 series includes 5 versions:

Power supply 24..230 VAC/VDC ±15% 50/60 Hz – 6 Watt/VA	
ATR444-13ABC	1 analogue input + 3 relays 5 A + 2 SSR + 4 D.I. + 1 analogue output V/mA + 1 CT
ATR444-14ABC-T	1 analogue input + 4 relays 5 A + 2 SSR + 2 D.I. + 1 analogue output V/mA + 1 CT + RS485
ATR444-15ABC	1 analogue input + 5 relays 5 A + 2 SSR + 4 D.I. + 1 CT
ATR444-22ABC	2 analogue input + 2 relays 5 A + 2 SSR + 4 D.I. + 1 analogue output V/mA + 2 CT
ATR444-24ABC-T	2 analogue input + 4 relays 5 A + 2 SSR + 4 D.I. + 2 analogue output V/mA + 1 CT + RS485

3 Technical Data

3.1 General Features

Displays	4 digits 0,63" + 5 digits 0,39" + 5 digits 0,33" + bar graph
Operating temperature	Temperature: 0-45° C -Humidity 35..95 uR%
Sealing	IP65 front panel (with gasket) - IP20 box and terminals (UL not evaluated)
Material	Box and front panel: PC UL94V2 self-extinguishing
Weight	Approx. 245 g

3.2 Hardware Features

Analogue inputs	<p>A11 – A12: Configurabile via software.</p> <p>Ingresso: Termocoppie tipo K, S, R, J,T,E,N,B. Compensazione automatica del giunto freddo da -25..85 °C.</p> <p>Termoresistenze: PT100, PT500, PT1000, Ni100, PTC1K, NTC10K (β 3435K)</p> <p>Ingresso V/mA: 0-1 V, 0-5 V, 0-10 V, 0-20 o 4-20 mA, 0-60 mV.</p> <p>Ingresso Pot: 1..150 KΩ.</p> <p>CT (trasformatore amperometrico): 50 mA.</p>	<p>Tolerance (@25° C) ± 0.2% ±1 digit (on F.s.) for thermocouple, thermoresistance and V/mA. Cold junction accuracy 0.1° C/°C.</p> <p>Impedance: 0-10 V: Ri>110 KΩ 0-20 mA: Ri<5 Ω 0-40 mV: Ri>1 MΩ</p>
Relay outputs	Configurable as command and alarm output.	Contacts: 5 A - 250 VAC for resistive load.
SSR output	Configurable as command and alarm output.	12/24 V, 25 mA.
Analogue outputs	Configurable as command, alarm output or as retransmission of process / setpoints.	Configurable: 0-10 V with 40000 points +/-0.2% (on F.s.) @25 °C; load >= 1 KΩ 4-20 mA with 40000 points +/-0.2% (on F.s.) @25 °C; load <= 250Ω
Power-supply	Extended power-supply 24..230 VAC/ VDC ±15% 50/60 Hz	Consumption: 13ABC 8W 14ABC-T 10W 15ABC 12W 22ABC 10W 24ABC-T 12W

3.3 Software Features

Regulation algorithms	ON-OFF with hysteresis. - P, PI, PID, PD with proportional time
Proportional band	0..9999°C o °F
Integral time	0,0..999,9 sec (0 excludes)
Derivative time	0,0..999,9 sec (0 excludes)
Controller functions	Manual or automatic Tuning, selectable alarm, protection of command and alarm setpoints.

3.4 Programming mode

by keyboard	..see paragraph 13
software LabSoftview	..on "Download section" of official pixsys site: www.pixsys.net
App MyPixsys	..through download the App MyPixsys on Google Play Store®, see paragraph 11 When activated by a reader/interrogator supporting NFC-V protocol, controller is to be considered a VICC (Vicinity Inductively Coupled Card) according to ISO/IEC 15693 and it operates at a frequency of 13.56 MHz. The device does not intentionally emit radio waves.

4 Dimensions and Installation

Dima di foratura
46 x 91 mm
Frontal panel
cut-out
Trou de panneau

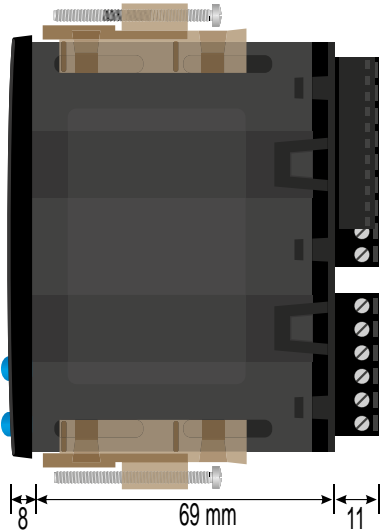

Memory Card USB (optional)
Cod. 2100.30.013

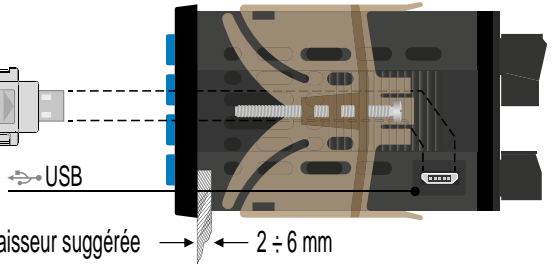

Spessore suggerito / Suggested thickness / Épaisseur suggérée → ← 2 ÷ 6 mm

5 Electrical wirings

This controller has been designed and manufactured in conformity to Low Voltage Directive 2006/95/EC, 2014/35/EU (LVD) and EMC Directive 2004/108/EC, 2014/30/EU (EMC). For installation in industrial environments please observe following safety guidelines:

- Separate control line from power wires.
- Avoid proximity of remote control switches, electromagnetic contactors, powerful engines.
- Avoid proximity of power groups, especially those with phase control.
- It is strongly recommended to install adequate mains filter on power supply of the machine where the controller is installed, particularly if supplied 230Vac.

The controller is designed and conceived to be incorporated into other machines, therefore CE marking on the controller does not exempt the manufacturer of machines from safety and conformity requirements applying to the machine itself.

- Wiring of pins 1...15, use crimped tube terminals or flexible/rigid copper wire with diameter 0.2 and 2.5 mm² (min. AWG28, max. AWG12, operating temperature: min. 70°C). Cable stripping length 7 to 8 mm.
- Wiring of pins 16...35, use crimped tube terminals or flexible/rigid copper wire with diameter 0.2 and 1.5 mm² (min. AWG28, max. AWG14, operating temperature: min. 70°C). Cable stripping length 6 to 7 mm.
- Use Copper or Copper-Clad Aluminum Conductors Only or AL-CU or CU-AL.

5.1 Wiring diagram

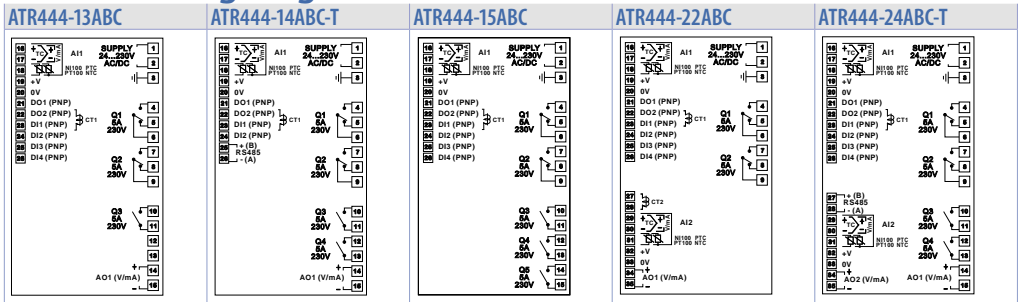

5.1.a Power Supply

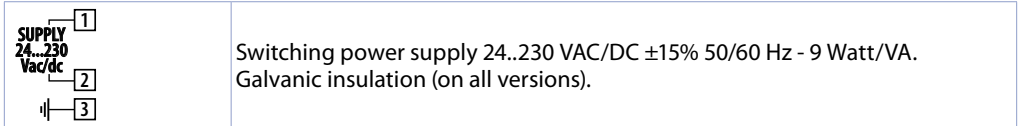

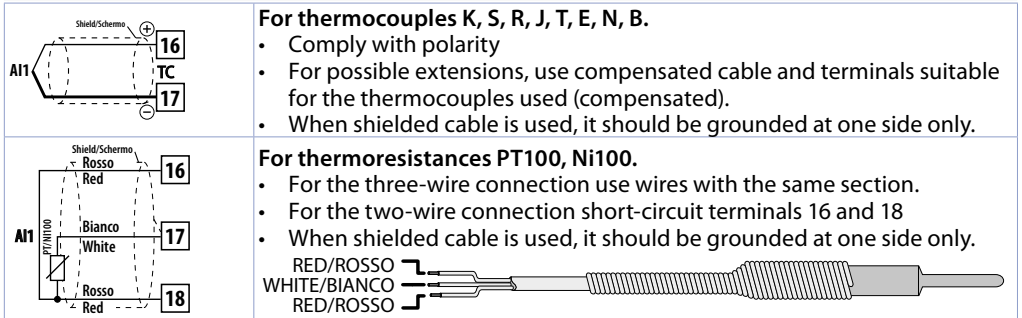

5.1.b Analogue Input A11

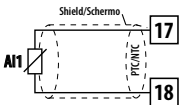
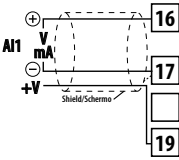

	<p>For thermoresistances NTC, PTC, PT500, PT1000 and linear potentiometers.</p> <p>When shielded cable is used, it should be grounded at one side only to avoid ground loop currents.</p>
	<p>For linear signals in Volt and mA</p> <ul style="list-style-type: none"> Comply with polarity When shielded cable is used, it should be grounded at one side only to avoid ground loop currents. It's possible to select +V at 12Vdc or 24Vdc, by configuring parameter 334 $\mu.OuT$ (GROUP G1 - $d.SP.$ - Display and interface).

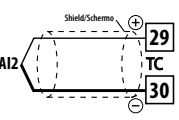
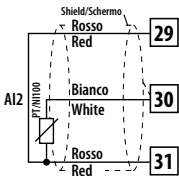
5.1.c Analogue Input AI2 (only ATR444-2xABC-x)

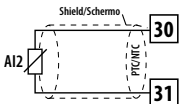
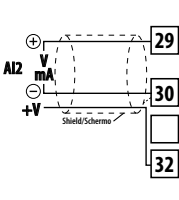
	<p>For thermocouples K, S, R, J, T, E, N, B.</p> <ul style="list-style-type: none"> Comply with polarity For possible extensions, use compensated cable and terminals suitable for the thermocouples used (compensated). When shielded cable is used, it should be grounded at one side only.
	<p>For thermoresistances PT100, Ni100.</p> <ul style="list-style-type: none"> For the three-wire connection use wires with the same section. For the two-wire connection short-circuit terminals 29 and 31. When shielded cable is used, it should be grounded at one side only. 
	<p>For thermoresistances NTC, PTC, PT500, PT1000 and linear potentiometers.</p> <p>When shielded cable is used, it should be grounded at one side only to avoid ground loop currents.</p>
	<p>For linear signals in Volt and mA</p> <ul style="list-style-type: none"> Comply with polarity When shielded cable is used, it should be grounded at one side only to avoid ground loop currents. To power the sensor connected to AI2 through +V (terminal 32), short-circuit 0 V (terminal 33) with AI2 ground input (terminal 30). + V at 12Vdc or 24Vdc can be selected by configuring parameter 334 $\mu.OuT$ (GROUP G1 - $d.SP.$ - Display and interface).

5.1.d CT1 input

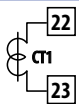
	<p>To enable CT1 input, modify parameter 366 $ct.F.$</p> <ul style="list-style-type: none"> Input for 50 mA amperometric transformer. Sampling time 100 ms. Configurable by parameters.
--	--

5.1.e CT2 input (only ATR444-22ABC)

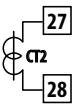
	<p>To enable CT2 input, modify parameter 377 $ct.ZF.$</p> <ul style="list-style-type: none"> Input for 50 mA amperometric transformer. Sampling time 100 ms. Configurable by parameters.
--	---

5.1.f Digital inputs



Digital inputs can be enabled by parameters.

Close pin "DIx" on pin "+V" to enable digital input.

It is possible to put in parallel the digital inputs of different devices joining together the 0V pins (20).

In the version ATR444-14ABC-T only DI1 and DI2 are available

5.1.g Serial input (only ATR444-xxxx-T)

ATR444-14ABC-T

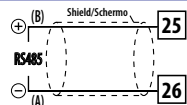

Modbus RS485 communication.
RTU Slave with galvanic insulation.

ATR444-24ABC-T

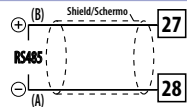

It is recommended to use the twisted and shielded cable for communications.

5.1.h Digital outputs



Digital output PNP (including SSR) for command or alarm.

Range 12 VDC/25 mA or 24 VDC/15mA selectable by parameter 334 *o.out*. (GROUP G1 - *d.SP* - Display and interface)

Wire the positive control (+) of the solid state relay to the pin DO(x).
Wire the negative control (-) of the solid state relay to the pin 0V.

5.1.i AO1 Analogue output

ATR444-13ABC, ATR444-14ABC-T and ATR444-24ABC-T



Linear output in **mA** or **V** (galvanically isolated) configurable as command, alarm or retransmission of process-setpoint.

ATR444-22ABC



The selection mA or Volt for the linear output depends on the parameters configuration.

5.1.j AO2 Analogue output (only ATR444-24ABC-T)



Linear output in **mA** or **V** (galvanically isolated) configurable as command, alarm or retransmission of process-setpoint.

The selection mA or Volt for the linear output depends on the parameters configuration.

5.1.k Relays output Q1 and Q2

	<p>Electrical endurance</p>	<p>Capacity: 2 A, 250 VAC, resistive loads, 10^5 operations. 20/2 A, 250 VAC, $\cos\phi = 0.3$, 10^5 operations. See chart below.</p>
	<p>The output Q1 works through 2 independent relays and both contacts can be opened to manage the valves (see figure).</p>	





5.1.l Relays output Q3, Q4 and Q5 (where required)

	<p>Life Curve</p>	<p>Capacity</p> <ul style="list-style-type: none"> 5 A, 250 Vac, resistive loads; min. 100×10^3 operations. 1/8 HP 277 Vac; min. 100×10^3 operations. <p>See chart below.</p> <p>NB: relays 3, 4 and 5 are not present in all ATR444 versions</p>
--	--------------------------	--



6 Numeric Indicators (Display)

	<p>Normally it displays the process.</p> <p>During the configuration phase, it displays the name of parameter being inserted.</p> <p>Displays the selected value on the parameter 327 $u.i.d.$ (factory settings: setpoint)</p> <p>During the configuration phase it displays the parameters group or the number of the parameter being inserted. I</p> <p>Displays the selected value on the parameter 328 $u.i.d.$ (factory settings: state)</p> <p>During the configuration phase it displays the parameter value being inserted.</p>
--	--

6.1 Meaning of Status Lights (Led)

C1	ON when the command output 1 is active. In versions with single analog input, it is ON when the valve is opening. In the versions with two analog inputs, in case of command 1 on the motorized valve, it is permanently ON when the valve is opening and flashing during the closing phase.
C2	ON when the command output 2 is active. In versions with single analog input, it is ON when the valve is opening. In the versions with two analog inputs, in case of command 2 on the motorized valve, it is permanently ON when the valve is opening and flashing during the closing phase.
A1	ON when alarm 1 is active.
A2	ON when alarm 2 is active.
A3	ON when alarm 3 is active.
A4	ON when alarm 4 is active.
A5	ON when alarm 5 is active.
A6	ON when alarm 6 is active.
TUN	ON when the controller is executing an auto-tuning cycle.
MAN	ON when "Manual" function is active.
REM	ON when the controller communicates through serial. Flashes when the remote setpoint is enabled.
	Configurable on par. 331 <i>BAR_G</i> . Normally it indicates the percentage of the command output 1
%	Access when the bar graph indicates the percentage of the command output 1 or 2 q
	ON during the rising phase of the cycle
	ON during the falling phase of the cycle
	Both ON during parameter modification, when this is not a default value.

6.2 Keys

	<ul style="list-style-type: none"> Increases the main setpoint. During the configuration phase it allows to scroll the groups of parameters and to scroll/modify the parameters. Increases the setpoints.
	<ul style="list-style-type: none"> Decreases the main setpoint. During the configuration phase it allows to scroll the groups of parameters and to scroll/modify the parameters. Decreases the setpoints.
FNC	<ul style="list-style-type: none"> Allows to enter the Tuning launch function, automatic/manual selection. During configuration works as exit key (ESC).
SET	<ul style="list-style-type: none"> Allows to visualize command and alarm setpoints. During configuration allows to enter the parameter to be modified and confirms the variation.
F1	• Configurable on the parameter 342 - <i>F1 F</i> .
F2	• Configurable on the parameter 348 - <i>F2 F</i> .
F3	• Configurable on the parameter 354 - <i>F3 F</i> .
F4	• Configurable on the parameter 360 - <i>F4 F</i> .

7 Dual input mode

Each ATR444-2xABC-x model is provided with two analogue inputs: it is possible to do mathematic operations between 2 measured process values, correlating obtained result to the command or alarm outputs, or to give a process value as remote setpoint. It is also possible to use the controller for 2 independent control loops.

7.1 Selection of process value related to the command output and to the alarms

When second analogue input is enabled (par. 19 *SEn2* other than *dISA*) it is possible to choose the process value to be related to command output, to alarms and to retransmission.

Following options are available:

- *R.IN.1*: Value read by input AI1
- *R.IN.2*: Value read by input AI2;
- *MEAN*: Mean between inputs AI1 and AI2;
- *dIFF*: Difference between inputs: AI1-AI2;
- *Ab.d.F.*: Difference between inputs as absolute value: AI1-AI2;
- *Sum*: Sum of inputs: AI1+AI2.
- *HIGH*: Greater value between AI1 and AI2.
- *LOW*: Lower value between AI1 and AI2.
- *REDUN*: The value read on AI1. If AI1 signs error (E-05), it goes automatically to the value read on AI2.
- Command 1 process must be selected on parameter 38 *cPr.1*
- Command 2 process must be selected on parameter 61 *cPr.2*
- The process related to the alarms must be selected on par. 136 *R.1.Pr.* for the alarm 1, on par. 156 *R.2.Pr.* for the alarm 2, on par. 176 *R.3.Pr.* for the alarm 3, and on par. 196 *R.4.Pr.* for the alarm 4, on par. 216 *R.5.Pr.* for the alarm 5, on par. 236 *R.6.Pr.* for the alarm 6 and on par. 256 *R.7.Pr.* for the alarm 7.
- The value to be retransmitted must be selected on par. 299 *rTn.1* and/or on par. 308 *rTn.2*

It is possible to choose what to visualize on display 2 selecting par. 327 *u.i.d.2* and on display 3 by selecting the parameter 328 *u.i.d.3*.

7.2 Remote setpoint by analogue input

It is possible to enable remote setpoint function setting *ENAb.* or *EN.ESL.* on par. 62 *rEn.5*.

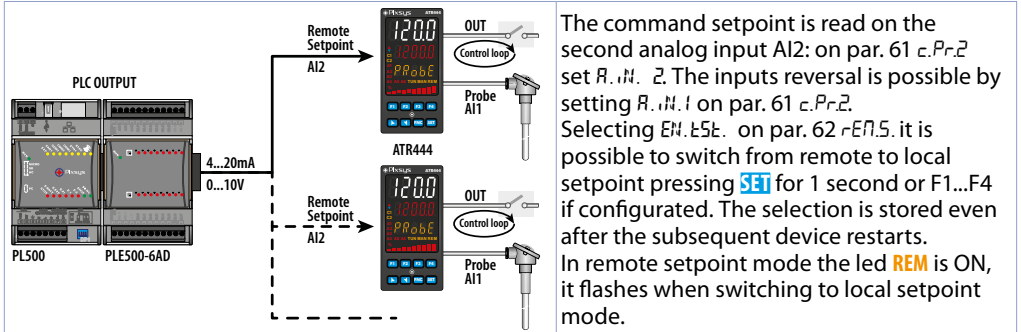

The command setpoint is read on the second analog input AI2: on par. 61 *cPr.2* set *R.IN.2*. The inputs reversal is possible by setting *R.IN.1* on par. 61 *cPr.2*. Selecting *EN.ESL.* on par. 62 *rEn.5* it is possible to switch from remote to local setpoint pressing **SET** for 1 second or F1...F4 if configured. The selection is stored even after the subsequent device restarts. In remote setpoint mode the led **REM** is ON, it flashes when switching to the local setpoint mode.

The decimal point setting parameter for the image input (or remote setpoint) is locked and modifies automatically when the command input decimal point is changed.

7.3 Remote setpoint by serial input

It is possible to enable remote setpoint function selecting *EN.SER.* or *EN.SE.L.* on par. 62 *rEn.5*. The remote setpoint must be written on the word modbus 1259 for the command 1 and 1260 for the command 2 (with tenth of degree if the command process is a temperature sensor).



It is possible to switch from remote to local setpoint pressing **SET** for 1 second or F1...F4 if configured. In remote setpoint mode the led **REM** is ON (if there is serial communication), it flashes when switching to local setpoint mode.

At restarting the controller keeps set in remote setpoint mode (the setpoint value is initialized to 0).

8 Controller Functions

8.1 Modification of main and alarm setpoint value

Setpoint value can be modified from keyboard as follows:

	Press	Display	Do
1		Value on display 2 changes.	Increases or decreases the main setpoint value.
2	SET	Visualizes the other setpoints on display 2. Display 3 shows the setpoint type.	
3		Value on display 2 changes.	Increases or decreases the alarm setpoint value.

8.2 Automatic Tune

Automatic tuning procedure allows a precise regulation without delving into the PID regulation algorithm. Selecting **Auto** on par. 83 *tun.1* (for the regulation loop 1), or on par. 109 *tun.2* (for the regulation loop 2), the controller analyzes the proces oscillations and optimizes the PID parameters. Led **TUN** flashes.

If the PID parameters are not yet selected, at the device switch-on, it is automatically launched the manual Tuning procedure described into the next paragraph.

8.3 Manual Tune

Manual procedure allows the user greater flexibility to decide when to update PID algorithm parameters. During the manual tuning, the device generates a step to analyze the system inertia to be regulated and, according to the collected data, modifies PID parameters.

After selecting **Manu.** on par. 83 *tun.1*, or on par. 109 *tun.2*, the procedure can be activated in 4 ways:

- **Running Tuning by keyboard:**
Press **ENC** until display 3 shows **tUNE** with display 2 on *d.5Ab*. and then press **SET**: display 2 shows **ENAb**. Led **TUN** switches ON and the procedure starts.
- **Running Tuning from F1... F4:**
Select **tUNE** on par. 342 *F1 F.* (or on par. 348 *F2 F.*, par. 354 *F3 F.*, par. 360 *F4 F.*). By pressing the button, the tuning activates/deactivates. Led **TUN** switches on when tuning is activated.
- **Running Tuning by digital input:**
Select **tUNE** on par. 275 *d.1.F.* (or on par. 284 *d.1.2F.*, par. 293 *d.1.3F.*, par. 302 *d.1.4F.*). At first activation of digital input (commutation on front panel) led **TUN** led switches on and at second activation switches off.
- **Running Tuning by serial input:**
Write 1 on word modbus 1224 (command 1) or 1225 (command 2): led **TUN** switches ON and the procedure starts. Write 0 to stop the tuning.

To avoid an overshoot, the treshold where the controller calculates new PID parameters is determined by this operation:

Tune threshold = Setpoint - "Set Deviation Tune" (par. 84 *5.d.t.1* or par. 110 *5.d.t.2*)

Ex.: if the sepoint is 100.0°C and the Par. 84 *5.d.t.1* is 20.0°C the threshold to calculate PID parameters is (100.0 - 20.0) = 80.0°C.

For a greater precision on PID parameters calculation it is suggested to start the manual tuning procedure when the process deviates from the setpoint.

8.4 Tuning once

Set **ManuE** on parameter 83 *tun.1*, or on parameter 109 *tun.2*.

Autotuning procedure is executed only once at next device restart. If the procedure doesn't work, it will be executed at next restart.

8.5 Synchronized tuning

Set *SYNCH*. on parameter 83 *tun.1* or on parameter 109 *tun.2*.

This procedure has been conceived to calculate correct PID values on multi-zone systems, where each temperature is influenced by the adjacent zones.

Writing on word modbus 1224 (for regulation loop 1) or 1225 (for regulation loop 2) the controller works as follows:

Word value	Action
0	Tune off
1	Command output OFF
2	Command output ON
3	Tune active
4	Tune completed: command output OFF (read only)
5	Tune not available: softstart function enabled (only reading)

Here below the functioning for regulation loop 1: the master switches-off or turns-on all zones (value 1 or 2 on word 1224) for a time long enough to create inertia on the system.



At this point the autotuning is launched (value 3 on word 1224). The controller executes the procedure for the calculation of the new PID values. When the procedure ends, the controller switches off the command output and selects the value 4 on word 1224. The master, who will always read the word 1224, will control the various zones and when all will have finished, will bring to 0 the value of word 1224: the various devices will regulate the temperature independently, with the new calculated values.

The master must read the word 1224 at least every 10 seconds or the controller will automatically exit the autotuning procedure.

8.6 Digital input functions

The ATR444 functions related to digital inputs, can be enabled by parameters 275 *d.1.F*, 284 *d.2.F*, 293 *d.3.F* and 302 *d.4.F*.

- *2E.5M.1*: Two threshold setpoint modification: with digital input active the controller regulates on **SET2**, otherwise regulates on **SET1**;
- *2E.5M.1.1*: Modification of 2 setpoints by digital input with impulse command;
- *3E.5M.1.1*: Modification of 3 setpoints by digital input with impulse command,
- *4E.5M.1.1*: Modification of 4 setpoints by digital input with impulse command,
- *5EE.1.1*: Controller regulates on **SET1**;
- *5EE.2.1*: Controller regulates on **SET2**;
- *5EE.3.1*: Controller regulates on **SET3**;
- *5EE.4.1*: Controller regulates on **SET4**;
- *5EAP.1*: Start of the regulator by digital input with impulse command;
- *5EoP.1*: Stop of the regulator by digital input with impulse command;
- *5E./5E.1*: Start / Stop of the controller by digital input with impulse command,
- *PUN.1*: The regulation is enabled only with digital input active,
- *Hold.1*: With digital input active the conversion is locked (visualization maintenance function);
- *tUNE*: Enables/disables the Tuning if par. 83 *tun.1* or par. 109 *tun.2* is selected as *PARn*;
- *MAN.1.1*: If par. 53 *PAR.1* or par. 76 *PAR.2* is selected as *ENAB.* or *EN.5Eo.*, with impulse command on digital input, the controller switches the related regulation loop, from automatic to manual and vice versa.
- *MAN.1.c*: If par. 53 *PAR.1* or par. 76 *PAR.2* is selected as *ENAB.* or *EN.5Eo.* the controller switches to manual the related regulation loop, with digital input active, otherwise the regulation is automatic.
- *CE.1.F*: On the regulation loop selected for this function (par. 278 *d.1.F* or 287 *d.2.F* or 296 *d.3.F* or 305 *d.4.F*), the controller execute a cooling type regulation with digital input active, otherwise the regulation is of heating type;
- *PRGM*: Programmer. If par. 312 *PRGM* is set on *ENAB.*, the device works as programmer 1 cycle, if digital input is activated, otherwise it is a basic controller.
- *R.1WH*: Reset kWh. It resets the energy value consumed by the system (set the power rating of the load on par. 54 *LP.1* or on par 77 *LP.2*).

- **R.I. 0:** Zero tare function: brings the related analogue input to 0. The analogue input is selected on par. 277 d. i.1.P. or 286 d. i.2.P. or 295 d. i.3.P. or 304 d. i.4.P.
- **M.RES.:** Allows the reset of the output if manual reset is active for the alarms and for the command outputs selected on par. 278 d. i.1.P. or 287 d. i.2.P. or 296 d. i.3.P. or 305 d. i.4.P.;
- **E.1.RUN:** If timer 1 is enabled (par. 420 E.T.1 different from d.5Rb.), with digital input active, the timer is switched to RUN, otherwise is kept in STOP;
- **E.1.S.E.:** If timer 1 is enabled (par. 420 E.T.1 different from d.5Rb.), acting on the digital input, the status of the timer switches from STOP to RUN and vice versa;
- **E.1.SER:** If il timer 1 is enabled (par. 420 E.T.1 different from d.5Rb.), acting on the digital input, the timer is switched to RUN;
- **E.1.END:** If il timer 1 is enabled (par. 420 E.T.1 different from d.5Rb.), acting on the digital input, the timer is switched to STOP;
- **E.2.RUN:** If timer 2 is enabled (par. 423 E.T.2 different from d.5Rb.), with digital input active, the timer is switched to RUN, otherwise is kept in STOP;
- **E.2.S.E.:** If timer 2 is enabled (par. 423 E.T.2 different from d.5Rb.), acting on the digital input, the status of the timer switches from STOP to RUN and vice versa;
- **E.2.SER:** If timer 2 is enabled (par. 423 E.T.2 different from d.5Rb.), acting on the digital input, the timer is switched to RUN;
- **E.2.END:** If timer 2 is enabled (par. 423 E.T.2 different from d.5Rb.), acting on the digital input, the timer is switched to STOP;
- **Ld.CFG:** With digital input active, the access to setpoint configuration/modification is locked;
- **uP.KES:** the digital input simulates the operation of 
- **down.K:** the digital input simulates the operation of 
- **FNC. K:** the digital input simulates the operation of **FNC**
- **SEE. K:** the digital input simulates the operation of **SET**
- **REM.S.E.:** If on par. 62 r.E.T.5. it is selected ENRb. or EN.SER.), with digital input active the remote setpoint is enabled, otherwise the setpoint is local. On par. 278 d. i.1.P. or 287 d. i.2.P. or 296 d. i.3.P. or 305 d. i.4.P. it is necessary to select the reference regulation loop.

8.7 Automatic / Manual regulation for % output control

This function allows to switch from automatic functioning to manual command of the output percentage.

With par. 53 R.P.R.1 (for regulation loop 1) or par. 76 R.P.R.2 (for regulation loop 2) it is possible to select two modes.

1 First selection (ENRb.) allows to enable with **FNC** the writing P.--- on display 2, while on display 3 is showed RuLoM.

Press **SET** to visualize **MAN**; it's now possible, during the process visualization, modify through the keys **▲** and **▼** the output percentage. To back to automatic, with the same procedure, select **RuLoM**. on display 3: immediately led **MAN** switches off and functioning backs to automatic.

2 Second selection (EN.SLo.) enables the same functioning but with two important variants:

- If there is a temporary power failure or after switch-off, the manual functioning as well as the previous output percentage value will be maintained at restarting.
- If the sensor breaks during automatic functioning, the controller switches to manual mode while maintaining the output percentage command unchanged as generated by the PID immediately before breakage.

Ex: on an extruder the command in percentage of the resistance (load) is maintained also in case of input sensor failure.

8.8 Heater Break Alarm on CT (Current Transformer)

This function allows to measure load current to manage an alarm during a malfunctioning with power in short circuit, always open or partial break of the charge. To enable this function set 50 Hz or 60 Hz on par. 287 $c.t.i.f.$ and the value of the connected transformer, on par. 288 $c.t.l.u.$.

- Select on par. 368 $H.b.i.R.$ the regulation loop referred to the current measure and the Heater Break Alarm intervention.
- Select on par. 369 $H.b.i.t.$ the Heater Break Alarm intervention threshold in Ampere.
- Select on par. 370 $o.c.i.t.$ the intervention threshold in Ampere to control the overcurrent.
- Select on par. 371 $H.b.i.d.$ the delay time in seconds for the Heater Break Alarm intervention.
- It is possible to associate an alarm, selecting $H.b.R.$ on par. 215 $RL5F$ or par. 155 $RL2F$ or par. 175 $RL3F$ or par. 195 $RL4F$ or par. 215 $RL5F$ or par. 235 $RL6F$ or par. 255 $RL7F$.

It is possible to visualize on display 2 or 3 the average current, selecting $AMP.i$ on par. 327 $V.i.d.2.$ or on par. 328 $V.i.d.3.$

Selecting 0 on par. 369 $H.b.i.t.$ it is possible to visualize the current consumption without generating an Heater Break Alarm.

In the version ATR444-22ABC 2 CT inputs are available: for the second CT configuration refer to "Group I2 - $c.t.2$ Current Transformer 2".

8.9 Dual Action (Heating-Cooling)

The controller is suitable also for systems requiring a combined heating-cooling action.

The command output has to be configured as PID for Heating (Par. 40 $R.c.t.1$ or Par. 63 $R.c.t.2 = HEAT$ and $P.b.1$ or $P.b.2$ greater than 0), and one of the alarms ($RL.1.F.$, $RL.2.F.$, $RL.3.F.$, $RL.4.F.$, $RL.5.F.$, $RL.5.F.$, $RL.6.F.$ or $RL.7.F.$) has to be configured as $cool$. The command output must be connected to the actuator responsible for heating, while the alarm will control cooling action.

Parameters to be configured for the heating PID are:

$R.c.t.1$ or $R.c.t.2 = HEAT$ Command output action type (Heating);

$P.b.1$ or $P.b.2$: Heating proportional band;

$i.t.1$ or $i.t.2$: Integral time of heating and cooling;

$d.t.1$ or $d.t.2$: Derivative time of heating and cooling;

$c.t.1$ or $c.t.2$: Heating time cycle.

Parameters to be configured for the cooling PID related to regulation loop 1 and alarm 1 are:

$RL.1F = cool$. Alarm 1 selection (Cooling);

$P.b.\pi.t$: Proportional band multiplier;

$o.d.b.t$: Overlapping / Dead band;

$c.c.t.t$: Cooling time cycle.

Par. $P.b.\pi.1$ (that ranges from 1.00 to 5.00) determines the proportional band of cooling action basing on the formula:

Proportional band for cooling action = $P.b.1 \times P.b.\pi.1$

This gives a proportional band for cooling which will be the same as heating band if $P.b.\pi.1 = 1.00$, or 5 times greater if $P.b.\pi.1 = 5.00$.

Integral and derivative time are the same for both actions.

Par. $o.d.b.i$ determines the percentage overlapping between the two actions. For systems in which the heating output and cooling output must never be simultaneously active a Dead Band ($o.d.b.i \leq 0$), must be configured, vice versa you can configure an overlapping ($o.d.b.i > 0$).

The following figure shows an example of dual action PID (heating-cooling) with $i.t.1 = 0$ and $d.t.1 = 0$.

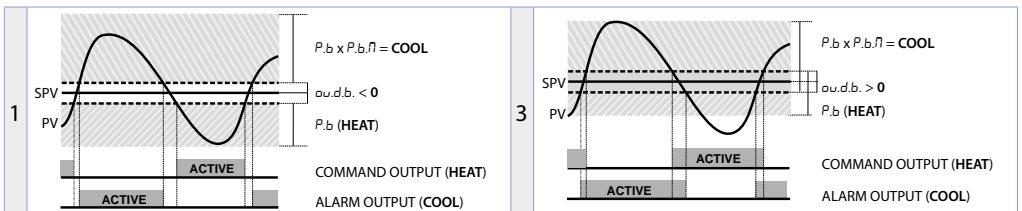

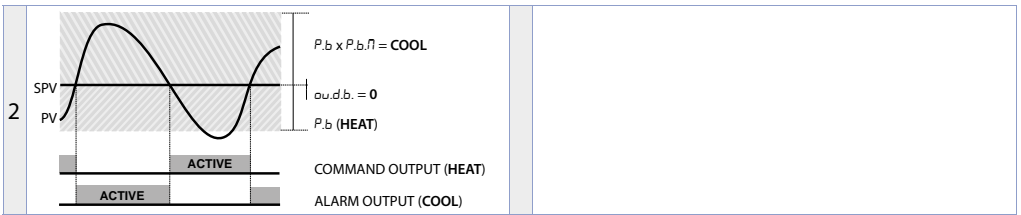

Parameter $c.c.t.i$ has the same meaning of cycle time for heating action $c.t.i$.

Parameter $co.F.i$ (Cooling Fluid) pre-selects the proportional band multiplier $P.b.n.i$ and the cooling PID cycle time $c.c.t.i$ according to cooling fluid type:

$co.F.i$	Cooling fluid type	$P.b.n.i$	$c.c.t.i$
R_{ir}	Air	1.00	10
$o.i.L$	Oil	1.25	4
$H2O$	Water	2.50	2

Once parameter $co.F.i$ has been selected, the parameters $P.b.n.i$, $o.d.b.i$ and $c.c.t.i$ can be however modified.

8.10 LATCH ON Function

For use with input $P.o.t.$ and with linear input (0..10 V, 0..40 mV, 0/4..20 mA) it is possible to associate start value of the scale (par. 4 $L.L.i.1$ or par. 22 $L.L.i.2$) to the minimum position of the sensor and value of the scale end (par. 5 $u.L.i.1$ or par. 23 $u.L.i.2$) to the maximum position of the sensor (par. 11 $L.t.c.1$ or par. 29 $L.t.c.2$ configured as $S.t.H.d.R$).

It is also possible to fix the point in which the controller will display 0 (however keeping the scale range between $L.L.i.1/L.L.i.2$ and $u.L.i.1/u.L.i.2$) using the "virtual zero" option by selecting $u.o.S.t.o.$ or $u.o.t.o.n.$ on par. 11 $L.t.c.1$ or 29 $L.t.c.2$. Selecting $u.o.t.o.n.$ the virtual zero must be reset at each switching on; selecting $u.o.S.t.o.$ the virtual zero will remain fixed once calibrated. To use the LATCH ON function, configure the par. $L.t.c.1$ or $L.t.c.2$.

The tuning procedure starts by exiting the configuration after changing the parameter.

Then refer to the following table for the calibration procedure:

	Press	Display	Do
1	FNC	Exit parameters configuration. Display 3 visualizes writing $L.R.t.c.H$.	Place the sensor on minimum operating value (corresponding to $L.L.i.1/L.L.i.2$)
2	✓	Store value on minimum. Display shows LoH .	Place sensor on maximum operating value (corresponding to $u.L.i.1/u.L.i.2$).
3	▲	Store value on max. Display shows $HiGH$.	To exit standard proceeding press SET . For "virtual zero" setting, place the sensor to zero point.
4	FNC	Set virtual zero. Display shows $ZERo$. If "Virtual zero at start" is selected, point 4 must be repeated at each starting.	To exit procedure press SET .

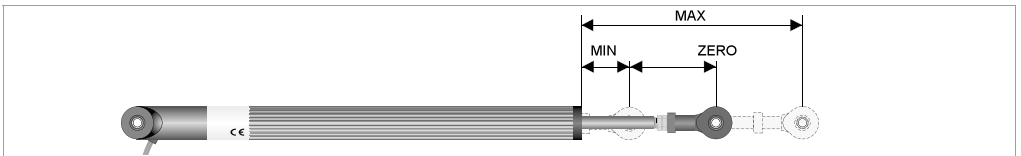

8.11 Soft-Start Function

The controller is provided with two types of softstart selectable on parameter 313 55.54. ("Softstart Type").

- 1 First selection (GRAD.) enables gradient softstart. AAt starting the controller reaches setpoint basing on the rising gradient set on parameter 315 55.57. ("Softstart Gradient") in Unit/hour (ex. °C/h). If parameter 318 55.58. ("Softstart Time") is different to 0, at starting when the time selected on par. 55.58. is elapsed, the controller stops to follow the gradient and reaches setpoint with the maximum power.
- 2 Second selection (PERC.) abilita enables output percentage softstart. On par. 317 55.5H. it is possible to set the threshold under which starts the softstart ("Softstart Threshold"). On par. 316 55.5E. ("Softstart Percentage") an output percentage is selectable (from 0 to 100), which controller keeps until the process exceeds the threshold set on par. 55.5H. or until the time in minutes set on par. 318 55.58. ("Softstart Time" word 2084).

If the Sof-Start function is active the automatic/manual Tuning function cannot be activated.

8.12 Retransmission function on analogue output

If not used as command, the analogue output can be used to retransmit process/ setpoint/ current read by the C.T. input/ output percentage.

Select on parameter 388 r.1.1 ("Retransmission 1") or on parameter 399 r.1.2 ("Retransmission 2") the value to be retransmitted and on parameter 389 r.1.4 ("Retransmission 1 Type") or on parameter 400 r.2.4 ("Retransmission 2 Type") the output type. It is possible also to select on parameters 390 r.1.1.1. and 391 r.1.1.2. or 401 r.2.1.1. and 402 r.2.1.2. the input value rescale limits.

8.13 Timer functions

The controller integrates two timers that can be independent, sequential or looped together.

Timer 1 is enabled on parameter 420 t.1.r.1; timer 2 on parameter 423 t.1.r.2:

ENRb. the timer starts from the keyboard or digital input (user intervention is required)

EN.5ER. the timer starts counting when the regulator is in RUN.

The timer time-base set in MM.55 or HH.MM by changing parameters 421 t.b.t.1 for timer 1 and 424 t.b.t.2 for timer 2.

In parameter 426 t.1.r.5. can be define whether the timers should be independent or related to each other.

5.MGL. The timers work independently of each other.

SEBwE. When timer 1 ends, timer 2 starts. The sequence is active only by starting timer 1. When timer 2 expires, the sequence is interrupted.

LooP When a timer ends, another starts: the sequence repeats itself cyclically.

To change the duration of the counting time, follow the steps below:

	Press	Display	Do
1	SET	Press until t.ME 1 or t.ME 2 visualized on display 1.	
2	▲▼	Digits on display 2 changes.	Increase or decrease time value for the selected timer.

To start the keyboard count follow the steps below:

	Press	Display	Do
1	FNC	Press until t.ME 1 or t.ME 2 visualized on display 3. Display 2 shows STOP if the timer is stopped, otherwise it shows the remaining time.	
2	SET	The timer stops if active or starts counting if in StOP.	

Start/Stop of Timer is possible also by digital input (see parameters d. 1.F ... d. 1.4F.) or by key functions (see parameters F1 F. ... F4 F.).

The alarm outputs can be associated with the timers (parameters *AL.1F* ... *AL.5F*). On parameters 425 *AL.1I* and 333 *AL.2I* is possible to select the activation mode. The proposed solutions are as follows:

- SEPR* Alarm active during timer counting
- ENd* Alarm active when the timer expiry
- WRRN* Alarm active 5 " before the timer expiry

9 Programmer (1 cycle, 12 steps)

ATR444 integrates the programmer mode allowing process 1 to follow a cycle set by the user and consisting of maximum 12 steps. To enable this function select *ENRb* on parameter 312 *PRGM* ("Programmer").





In this case F1, F2, F3 and F4 are not programmable, but perform the following functions:

- F1: allows to enter the cycle modification management. When device is in START, the cycle can only be displayed.
- F2: allows to cyclically display the setpoint, the running step and other cycle data.
- F3: resets the energy consumed value by command 1, if enabled on parameter 54 *LP.r.1* ("Load Power Rating 1").
- F4: manages the regulation or cycle START/STOP.

Selecting *PRGM* on parameter 275 *d.1.F* (or on 284 *d.1.ZF*, or on 293 *d.1.ZF* or on 302 *d.1.HF*.) it is possible to change mode from controller to programmer, by acting on digital inputs.

9.1 Programming (or modifying) cycle data

Follow the steps listed in the following table:

	Press	Display	Do
1	F1	Display 1 shows <i>01-1</i> . Display 2 shows the time of the step.	Press F1 to save and exit from programming cycle.
2	 or 	Scroll the different steps. The data on display 1 enables two information: <ul style="list-style-type: none"> • The step number (first two digits) • The type of data (time, temperature or status of the auxiliary output). 	Ex: <i>01-1</i> step 1 time <i>01-5</i> step 1 setpoint <i>01-R</i> step 1 auxiliary NB: the auxiliary setting is present only if enabled on at least one alarm parameter (selection <i>SEPR</i>).
3	SET to confirm	Enables the value modification. Display 2 flashes. This point is not allowed when the cycle is in START.	
4	 or 	The displayed value is increased or decreased	Insert the new data. <ul style="list-style-type: none"> • During time entry (hh:mm) set --:-- for infinite time or End for end of cycle (if not all available steps are used) • During setpoint entry set the arrival temperature at the end of the step • During auxiliary entry select <i>oN</i> for active auxiliary during step, otherwise set <i>oFF</i>.
5	SET to confirm	Confirm the new value.	
6	F1	Save and exit cycle programming.	

9.2 Cycle start

There are different options to start the cycle (START):

- Press key 4 for at least 1 second to START / STOP the controller.
- Through digital input if configured.
- Through serial port where present.

9.3 Recovery of interrupted cycle

Recovery function is particularly useful for kilns temperature regulation. After a power failure, at restarting ATR444 can resume the interrupted cycle. There are two recovery modes.

9.3.1 Recovery with automatic gradient

To enable cycle recovery with automatic gradient, set 1 on parameter 321 as *r. i. c. d.* This mode does not operate for cooling regulations. At restart, after a power failure, controller will operate like this:

1. If a power failure occurs during a rising step, the gradient will be same as the operating step (setpoint temperature equal to the temperature read by the sensor).
2. If a power failure occurs during a holding step, two options are possible. If gap between process and setpoint is limited (not exceeding the value on parameter 320 *P.L.S.E.*) cycle will resume from the point of interruption; if the gap is bigger but controller has not yet executed a cooling step, the cycle will go back to the closest rising step and will repeat the procedure as explained on point 1.
3. If a power failure occurs during a cooling step or a holding step (dwell) after that a cooling step has already been completed, the setpoint will match the the temperature read by the sensor, without including any rising and even skipping to next step if necessary (this a safety tip particularly for glass working).

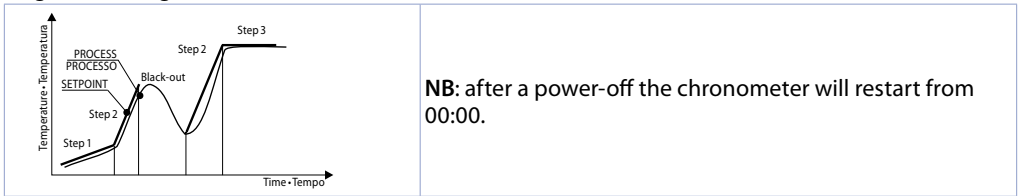

9.3.2 Recovery with recovery gradient

To enable cycle recovery with a recovery gradient, enter on parameter 321 *r. i. c. d.* a value (degrees/hour if temperature) greater than 1. At restarting if the kiln temperature (process) is lower than the setpoint, ATR444 locks the working cycle executing a step with the rising gradient set on parameter 321 *r. i. c. d.* to return to the setpoint value entered before the power failure and the cycle restarts from that point. In recovery mode the display shows *RECOVERY STEP* instead of the cycle number.

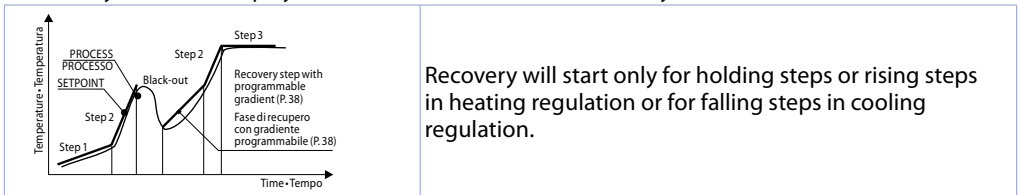

9.4 Waiting step end

This function has been conceived to control kilns working cycles, whenever the kiln cannot follow gradients programmed by the user. If at step end the difference between process and setpoint values is greater than the value on parameter 320 *P.L.S.E.* ("Max Gap Step End"), controller starts with the next step only after waiting for the time programmed on parameter 319 *U.L.S.E.* ("Waiting Time Step End"), or when this gap becomes lower than parameter 320 *P.L.S.E.*.

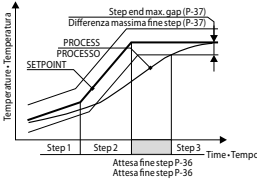

To disable this function fix at 0 end step waiting time *U.L.S.E.*

While waiting step end, instead of number of steps, the displays shows *WAITING STEP END.*

10 Serial communication

ATR444-x4ABC-T is equipped with RS485 and can receive/broadcast data via serial communication using MODBUS RTU protocol. The device can only be configured as a Slave. This function enables the control of multiple controllers connected to a supervisory system / SCADA.

Each controller responds to a Master query only if the query contains the same address as parameter 410 *S.L.Ad.* ("Slave Address").

The addresses permitted range from 1 to 254 and there must not be controllers with the same address on the same line.

Address 255 can be used by the Master to communicate with all the connected equipment (broadcast mode), while with 0 all the devices receive the command, but no response is expected.

The baud rate is selected on parameter 411 *bd.rt.* ("Baud Rate"). The baud rate is selected on parameter 412 *S.P.P.* (Serial Port Parameters).

The controller can introduce a delay (in milliseconds) of the response to the master request. This delay must be set on parameter 413 *S.E.dE.* ("Serial Delay").

Each parameter modification is saved by the controller in the EEPROM memory (100000 writing cycles), while the setpoints are saved with a delay of 10 seconds after the last modification.

Changes made to words that are different from those reported in the following table can lead to malfunction.

Modbus RTU protocol features

Baud-rate	Selectable on parameter 411 <i>bd.rt.</i>	
	1200bit/s	28800bit/s
	2400bit/s	38400bit/s
	4800bit/s	57600bit/s
	9600bit/s	115200bit/s
Formato	Selectable on parameter 412 <i>S.P.P.</i>	
	8N1	8N2
	8E1	8E2
	8O1	8O2
Funzioni supportate	WORD READING (max 50 word) (0x03, 0x04)	
	SINGLE WORD WRITING (0x06)	
	MULTIPLE WORDS WRITING (max 50 word) (0x10)	

Here below a list of all available addresses and supported functions:

RO = Read Only	R/W = Read/Write	WO = Write Only
----------------	------------------	-----------------

Modbus address	Description	Read Write	Reset value
0	Device type	RO	55x
1	Software version	RO	Flash
2	Boot version	RO	Flash
3	Slave Address	RO	Eepr/dip
6	Baud rate	RO	Eepr/dip
50	Slave address automatic learning	WO	-
51	System code comparison for slave address automatic learning	WO	-
500	Loading default values (write 9999)	RW	0
501	Restart ATR244 (write 9999)	RW	0
502	Setpoint storing delay time	RW	10
503	Parameters storing delay time	RW	1
601	First character of the custom alarm message 1	RW	"u"
...			
623	Last character of the custom alarm message 1	RW	0
651	First character of the custom alarm message 2	RW	"u"
...			
673	Last character of the custom alarm message 2	RW	0
701	First character of the custom alarm message 3	RW	"u"
...			
723	Last character of the custom alarm message 3	RW	0
751	First character of the custom alarm message 4	RW	"u"
...			
773	Last character of the custom alarm message 4	RW	0
801	First character of the custom alarm message 5	RW	"u"
...			
823	Last character of the custom alarm message 5	RW	0
851	First character of the custom alarm message 6	RW	"u"
...			
873	Last character of the custom alarm message 6	RW	0
901	First character of the custom alarm message 7	RW	0
...			
923	Last character of the custom alarm message 7	RW	"u"
1000	AI1 value (degrees with tenth)	RO	-
1001	AI2 value (degrees with tenth)	RO	-
1002	Average between AI1 and AI2 $[(AI1 + AI2) / 2]$ (degrees with tenth)	RO	0
1003	Difference between AI1 and AI2 $(AI1 - AI2)$ (degrees with tenth)	RO	0
1004	Module of the difference between AI1 and AI2 $(AI1 - AI2)$ (degrees with tenth)	RO	0
1005	Sum of AI1 and AI2 $(AI1 + AI2)$ (degrees with tenth)	RO	0
1006	Greater value between AI1 and AI2 (degrees with tenth)	RO	0
1007	Lower value between AI1 and AI2 (degrees with tenth)	RO	0
1008	AI1 value. AI2 value if AI1 signs error (E-DS) (degrees with tenth)	RO	0
1009	Real setpoint (gradient) of the regulation loop 1	RO	0
1010	Real setpoint (gradient) of the regulation loop 2	RO	0
1011	Alarms status (0 = absent, 1 = present) Bit0 = Alarm 1 Bit4 = Alarm 5 Bit1 = Alarm 2 Bit5 = Alarm 6 Bit2 = Alarm 3 Bit6 = Alarm 7 Bit3 = Alarm 4	RO	0

Modbus address	Description	Read Write	Reset value
1012	Error flags 1 Bit0 = AI1 process error (sensor 1) Bit1 = AI2 process error (sensor 2) Bit2 = Cold junction error Bit3 = Safety error Bit4 = Generic error Bit5 = Hardware error Bit6 = Error H.B.A. (partial rupture of the load) Bit7 = Error H.B.A. (SSR in short circuit) Bit8 = Overcurrent error Bit9 = Parameters out of range error Bit10= CPU eeprom writing error Bit11= RFid eeprom writing error Bit12= CPU eeprom reading error Bit13= RFid eeprom reading error Bit14= Eeprom calibrations bench corrupted Bit15= Eeprom constants bench corrupted	RO	0
1013	Error flags 2 Bit0 = Missing calibrations error Bit1 = Eeprom CPU bench parameters corrupted Bit2 = Eeprom CPU setpoint bench corrupted Bit3 = RFid memory not formatted Bit4 = AI2 error disabled	RO	0
1014	Digital inputs status (0 = not active, 1 = active) Bit0 = Ingresso dig. 1 Bit2 = Ingresso dig. 3 Bit1 = Ingresso dig. 2 Bit3 = Ingresso dig. 4	RO	0
1015	Outputs status (0 = OFF, 1 = ON) Bit 0 = Q1 (NO) Bit 4 = Q4 Bit 1 = Q1 (NC) Bit 5 = Q5 Bit 2 = Q2 Bit 6 = DO1 Bit 3 = Q3 Bit 7 = DO2	RO	0
1016	Stato led (0 = OFF, 1 = ON) Bit 0 = Led UP arrow Bit 8 = Led A5 Bit 1 = Led C1 Bit 9 = Led A6 Bit 2 = Led C2 Bit 10 = Led TUN Bit 3 = Led A1 Bit 11 = Led MAN Bit 4 = Led A2 Bit 12 = Led REM Bit 5 = Led A3 Bit 13 = Led point time 2 Bit 6 = Led A4 Bit 14 = Led point time 3 Bit 7 = Led % Bit 15 = Led DOWN arrow	RO	0
1017	Key status (0 = released, 1 = pressed) Bit 0 = Key UP arrow Bit 4 = Key F4 Bit 1 = Key DOWN arrow Bit 5 = Key F3 Bit 2 = Key FNC Bit 6 = Key F2 Bit 3 = Key SET Bit 7 = Key F1	RO	0
1018	Cold junction 1 temperature (degrees with tenth)	RO	-
1019	Cold junction 2 temperature (degrees with tenth)	RO	-
1020	Current CT1 instantaneous (Ampere with tenth)	RO	0
1021	Current CT1 average (Ampere with tenth)	RO	0
1022	Current CT1 ON (Ampere with tenth)	RO	0
1023	Current CT1 OFF (Ampere with tenth)	RO	0
1024	Current CT2 instantaneous (Ampere with tenth)	RO	-

Modbus address	Description	Read Write	Reset value
1025	Current CT2 average (Ampere with tenth)	RO	-
1026	Current CT2 ON (Ampere with tenth)	RO	-
1027	Current CT2 OFF (Ampere with tenth)	RO	-
1028	Feedback valve position (0-100)	RO	-
1100	AI1 value with decimal point selection	RO	-
1101	AI2 value with decimal point selection	RO	-
1102	Average between AI1 and AI2 $[(AI1 + AI2) / 2]$ with decimal point selection	RO	0
1103	Difference between AI1 and AI2 $(AI1 - AI2)$ with decimal point selection	RO	0
1104	Module of the difference between AI1 and AI2 $(AI1 - AI2)$ with decimal point selection	RO	0
1105	Sum of AI1 and AI2 $(AI1 + AI2)$ with decimal point selection	RO	0
1106	Greater value between AI1 and AI2 with decimal point selection	RO	-
1107	Lower value between AI1 and AI2 with decimal point selection	RO	-
1108	AI1 Value. AI2 value if AI1 signs error (E-05) with decimal point selection	RO	-
1109	Real setpoint (gradient) of the regulation loop 1 with decimal point selection	RO	0
1110	Real setpoint (gradient) of the regulation loop 2 with decimal point selection	RO	0
1200	Setpoint 1 of regulation loop 1 (degrees with tenth)	R/W	EEPROM
1201	Setpoint 2 of regulation loop 1 (degrees with tenth)	R/W	EEPROM
1202	Setpoint 3 of regulation loop 1 (degrees with tenth)	R/W	EEPROM
1203	Setpoint 4 of regulation loop 1 (degrees with tenth)	R/W	EEPROM
1204	Setpoint 1 del loop di regolazione 2 (gradi con decimo)	R/W	EEPROM
1205	Setpoint 2 del loop di regolazione 2 (gradi con decimo)	R/W	EEPROM
1206	Setpoint 3 del loop di regolazione 2 (gradi con decimo)	R/W	EEPROM
1207	Setpoint 4 del loop di regolazione 2 (gradi con decimo)	R/W	EEPROM
1208	Alarm 1 setpoint (degrees with tenth) Alarm 1 upper setpoint if Par. 135 $RL.1.F. = R.bRNd$	R/W	EEPROM
1209	Alarm 1 lower setpoint if Par. 135 $RL.1.F. = R.bRNd$ (degrees with tenth)	R/W	EEPROM
1210	Alarm 2 setpoint (degrees with tenth) Alarm 2 upper setpoint if Par. 155 $RL.2.F. = R.bRNd$	R/W	EEPROM
1211	Alarm 2 lower setpoint if Par. 155 $RL.2.F. = R.bRNd$ (degrees with tenth)	R/W	EEPROM
1212	Alarm 3 setpoint (degrees with tenth) Alarm 3 upper setpoint if Par. 175 $RL.3.F. = R.bRNd$	R/W	EEPROM
1213	Alarm 3 lower setpoint if Par. 175 $RL.3.F. = R.bRNd$ (degrees with tenth)	R/W	EEPROM
1214	Alarm 4 setpoint (degrees with tenth) Alarm 4 upper setpoint if Par. 195 $RL.4.F. = R.bRNd$	R/W	EEPROM
1215	Alarm 4 lower setpoint if Par. 195 $RL.4.F. = R.bRNd$ (degrees with tenth)	R/W	EEPROM
1216	Alarm 5 setpoint (degrees with tenth) Alarm 5 upper setpoint if Par. 215 $RL.5.F. = R.bRNd$	R/W	EEPROM
1217	Alarm 5 lower setpoint if Par. 215 $RL.5.F. = R.bRNd$ (degrees with tenth)	R/W	EEPROM
1218	Alarm 6 setpoint (degrees with tenth) Alarm 6 upper setpoint if Par. 235 $RL.6.F. = R.bRNd$	R/W	EEPROM
1219	Alarm 6 lower setpoint if Par. 235 $RL.6.F. = R.bRNd$ (degrees with tenth)	R/W	EEPROM
1220	Alarm 7 setpoint (degrees with tenth) Alarm 7 upper setpoint if Par. 255 $RL.7.F. = R.bRNd$	R/W	EEPROM
1221	Alarm 7 lower setpoint if Par. 255 $RL.7.F. = R.bRNd$ (degrees with tenth)	R/W	EEPROM
1222	Start/Stop 0=controller in STOP 1=controller in START	R/W	0

Modbus address	Description	Read Write	Reset value
1223	Hold conversion ON/OFF 0=Hold conversion OFF 1=Hold conversion ON	R/W	0
1224	Tune management for regulation loop 1 With automatic Tune (par. 83 $t_{un,1} = R_{u}t_{o}$): 0 = autotuning function OFF 1 = autotuning ON	RO	0
	With manual Tune (par. 83 $t_{un,1} = P_{RnU}$ or Q_{ncE}): 0 = autotuning function OFF 1 = autotuning ON	R/W	0
	With synchronized Tune (par. 83 $t_{un,1} = S_{ynch}$): 0 = autotuning function OFF 1 = command output OFF (forces the cooling) 2 = command output ON (forces the heating) 3 = autotuning ON 4 = autotuning ended	R/W	0
1225	Tune management for regulation loop 2 With automatic Tune (par. 109 $t_{un,2} = R_{u}t_{o}$): 0 = autotuning function OFF 1 = autotuning ON	RO	0
	With manual Tune (par. 109 $t_{un,2} = P_{RnU}$ or Q_{ncE}): 0 = autotuning function OFF 1 = autotuning ON	R/W	0
	With synchronized Tune (par. 109 $t_{un,2} = S_{ynch}$): 0 = autotuning function OFF 1 = command output OFF (forces the cooling) 2 = command output ON (forces the heating) 3 = autotuning ON 4 = autotuning ended	R/W	0
1226	Automatic/manual selection for regulation loop 1 0 = automatic; 1 = manual	R/W	0
1227	Automatic/manual selection for regulation loop 2 0 = automatic; 1 = manual	R/W	0
1228	Command output percentage for regulation loop 1 (0-10000) Heating output percentage with regulation 1 in double loop (0-10000)	R/W	0
1229	Command output percentage for regulation loop 1 (0-1000) Heating output percentage with regulation 1 in double loop (0-1000)	R/W	0
1230	Command output percentage for regulation loop 1 (0-100) Heating output percentage with regulation 1 in double loop (0-100)	R/W	0
1231	Cooling output percentage with regulation 1 in double loop (0-10000)	RO	0
1232	Cooling output percentage with regulation 1 in double loop (0-1000)	RO	0
1233	Cooling output percentage with regulation 1 in double loop (0-100)	RO	0
1234	Command output percentage for regulation loop 2 (0-10000) Heating output percentage with regulation 2 in double loop (0-10000)	R/W	0
1235	Command output percentage for regulation loop 2 (0-1000) Heating output percentage with regulation 2 in double loop (0-1000)	R/W	0
1236	Command output percentage for regulation loop 2 (0-100) Heating output percentage with regulation 2 in double loop (0-100)	R/W	0
1237	Cooling output percentage with regulation 2 in double loop (0-10000)	RO	0
1238	Cooling output percentage with regulation 2 in double loop (0-1000)	RO	0
1239	Cooling output percentage with regulation 2 in double loop (0-100)	RO	0

Modbus address	Description	Read Write	Reset value
1240	Command output manual reset for regulation loop 1: write 0 to reset the command output. In reading 0 = reset not allowed, 1 = reset allowed	R/W	0
1241	Alarms manual reset: write 0 to reset all alarms. In reading 0 = reset not allowed, 1 = reset allowed Bit0 = Alarm 1 Bit4 = Alarm 5 Bit1 = Alarm 2 Bit5 = Alarm 6 Bit2 = Alarm 3 Bit6 = Alarm 7 Bit3 = Alarm 4	R/W	0
1242	Command output manual reset for regulation loop 2: write 0 to reset the command output. In reading 0 = reset not allowed, 1 = reset allowed	R/W	0
1243	Alarm 1 remote status (0 = absent, 1 = present)	R/W	0
1244	Alarm 2 remote status (0 = absent, 1 = present)	R/W	0
1245	Alarm 3 remote status (0 = absent, 1 = present)	R/W	0
1246	Alarm 4 remote status (0 = absent, 1 = present)	R/W	0
1247	Alarm 5 remote status (0 = absent, 1 = present)	R/W	0
1248	Alarm 6 remote status (0 = absent, 1 = present)	R/W	0
1249	Alarm 7 remote status (0 = absent, 1 = present)	R/W	0
1250	Value AO1 by serial (Par. 388 $rL1 = Pd.bu5$)	R/W	0
1251	Value AO2 by serial (Par. 399 $rL2 = Pd.bu5$)	R/W	0
1252	Tare of zero AI1 (1 = tare; 2=reset tare)	R/W	0
1253	Tare of zero AI2 (1 = tare; 2=reset tare)	R/W	0
1254	Tare of zero average between AI1 and AI2 $[(AI1 + AI2) / 2]$ (1 = tare; 2 = reset tare)	R/W	0
1255	Tare of zero difference between AI1 and AI2 $(AI1 - AI2)$ (1 = tare; 2 = reset tare)	R/W	0
1256	Tare of zero module of the difference between AI1 and AI2 $(AI1 - AI2)$ (1 = tare; 2 = reset tare)	R/W	0
1257	Tare of zero sum of AI1 and AI2 $(AI1 + AI2)$ (1 = tare; 2 = reset tare)	R/W	0
1258	Zero tare AI1 and AI2 simultaneously (1=tare; 2= tare reset)	R/W	0
1259	Value of remote setpoint by command 1 serial	R/W	0
1260	Value of remote setpoint by command 2 serial	R/W	0
1300	Setpoint 1 of regulation loop 1, with decimal point selection	R/W	EEPROM
1301	Setpoint 2 of regulation loop 1, with decimal point selection	R/W	EEPROM
1302	Setpoint 3 of regulation loop 1, with decimal point selection	R/W	EEPROM
1303	Setpoint 4 of regulation loop 1, with decimal point selection	R/W	EEPROM
1304	Setpoint 1 of regulation loop 2, with decimal point selection	R/W	EEPROM
1305	Setpoint 2 of regulation loop 2, with decimal point selection	R/W	EEPROM
1306	Setpoint 3 of regulation loop 2, with decimal point selection	R/W	EEPROM
1307	Setpoint 4 of regulation loop 2, with decimal point selection	R/W	EEPROM
1308	Alarm 1 setpoint (degrees with tenth) Alarm 1 upper setpoint if Par. 135 $R.L.1.F. = R.bRNd$	R/W	EEPROM
1309	Alarm 1 lower setpoint if Par. 135 $R.L.1.F. = R.bRNd$ (degrees with tenth)	R/W	EEPROM
1310	Alarm 2 setpoint (degrees with tenth) Alarm 2 upper setpoint if Par. 155 $R.L.2.F. = R.bRNd$	R/W	EEPROM
1311	Alarm 2 lower setpoint if Par. 155 $R.L.2.F. = R.bRNd$ (degrees with tenth)	R/W	EEPROM
1312	Alarm 3 setpoint (degrees with tenth) Alarm 3 upper setpoint if Par. 175 $R.L.3.F. = R.bRNd$	R/W	EEPROM
1313	Alarm 3 lower setpoint if Par. 175 $R.L.3.F. = R.bRNd$ (degrees with tenth)	R/W	EEPROM

Modbus address	Description	Read Write	Reset value
1314	Alarm 4 setpoint (degrees with tenth) Alarm 4 upper setpoint if Par. 195 $RL.4.F. = R.bRNd$	R/W	EEPROM
1315	Alarm 4 lower setpoint if Par. 195 $RL.4.F. = R.bRNd$ (degrees with tenth)	R/W	EEPROM
1316	Alarm 5 setpoint (degrees with tenth) Alarm 5 upper setpoint if Par. 215 $RL.5.F. = R.bRNd$	R/W	EEPROM
1317	Alarm 5 lower setpoint if Par. 215 $RL.5.F. = R.bRNd$ (degrees with tenth)	R/W	EEPROM
1318	Alarm 6 setpoint (degrees with tenth) Alarm 6 upper setpoint if Par. 235 $RL.6.F. = R.bRNd$	R/W	EEPROM
1319	Alarm 6 lower setpoint if Par. 235 $RL.6.F. = R.bRNd$ (degrees with tenth)	R/W	EEPROM
1320	Alarm 7 setpoint (degrees with tenth) Alarm 7 upper setpoint if Par. 255 $RL.7.F. = R.bRNd$	R/W	EEPROM
1321	Alarm 7 lower setpoint if Par. 255 $RL.7.F. = R.bRNd$ (degrees with tenth)	R/W	EEPROM
1400	Remote process reset 1: by writing 1 the controller uses for the process the value measured in AI1 instead of the one written in the word 1402	R/W	0
1401	Remote process reset 2: by writing 1 the controller uses for the process the value measured in AI2 instead of the one written in the word 1403	R/W	0
1402	Remote process 1. The number written in this word will be the process value 1 that the device uses for setting and alarms (ADC1 disabled)	R/W	-
1403	Remote process 2. The number written in this word will be the process value 2 that the device uses for setting and alarms (ADC2 disabled)	R/W	-
2001	Parameter 1	R/W	EEPROM
2002	Parameter 2	R/W	EEPROM
...	Parameter ...	R/W	EEPROM
2503	Parameter 503	R/W	EEPROM

10.1 Serial compatibility with ATR401-22ABC-T

In existing plants where it is necessary to replace an ATR401-22ABC-T, it is possible to install a new ATR444-14ABC-T or ATR444-24ABC-T enabling the Modbus register's compatibility.

To enable the Modbus register's compatibility with the ATR401, simply enter the password 0401.

To return again to the ATR144 Modbus mapping, enter the password 0444.

The new register map is the following:



Modbus address	Description of compatibility registers	Read Write	Reset value
0	Device type	RO	EEPROM
1	Software version	RO	EEPROM
5	Address slave	RO	EEPROM
6	Boot version	RO	EEPROM
50	Automatic addressing	WO	-
51	System code comparison	WO	-
500	Loading default values (write 9999)	R/W	0
900	AI1 value (degrees with tenth)		
901	AI2 value (degrees with tenth)		
902	Average between AI1 and AI2 $[(AI1 + AI2) / 2]$ (degrees with tenth)		
903	Difference between AI1 and AI2 $(AI1 - AI2)$ (degrees with tenth)		
904	Module of the difference between AI1 and AI2 $(AI1 - AI2)$ (degrees with tenth)		
905	Sum of AI1 and AI2 $(AI1 + AI2)$ (degrees with tenth)		
1000	AI1 value (degrees with tenths for temperature sensors; digits for linear sensors)	RO	-
1001	Setpoint 1	R/W	EEPROM
1002	Setpoint 2	R/W	EEPROM

1003	Setpoint 3	R/W	EEPROM
1004	Setpoint 4	R/W	EEPROM
1005	Alarm 1	R/W	EEPROM
1006	Alarm 2	R/W	EEPROM
1007	Alarm 3	R/W	EEPROM
1008	Alarm 4	R/W	EEPROM
1009	Setpoint gradient	RO	EEPROM
1010	Relay status (0=OFF, 1=ON) Bit 0 = Q1 (NO) Bit 4 = Q4 Bit 1 = Q1 (NC) Bit 5 = Q5 Bit 2 = Q2 Bit 6 = DO1 Bit 3 = Q3 Bit 7 = DO2	RO	0
1011	Heating output percentage (0-10000)	R/W	0
1012	Cooling output percentage (0-10000)	RO	0
1013	Alarms status (0=None, 1=Active) Bit0 = Alarm 1 Bit4 = Alarm 5 Bit1 = Alarm 2 Bit5 = Alarm 6 Bit2 = Alarm 3 Bit6 = Alarm 7 Bit3 = Alarm 4	RO	0
1014	Manual reset: write 0 to reset all alarms. In reading (0 = Not resettable, 1 = Resettable) Bit0 = Alarm 1 Bit4 = Alarm 5 Bit1 = Alarm 2 Bit5 = Alarm 6 Bit2 = Alarm 3 Bit6 = Alarm 7 Bit3 = Alarm 4	R/W	0
1015	Error flags: Bit 0 = Eeprom writing error Bit 1 = Eeprom reading error Bit 2 = Cold junction error Bit 3 = AI1 error (probe 1) Bit 4 = AI2 error (probe 2) Bit 5 = Generic error Bit 6 = Hardware error Bit 7 = Missing calibration data error Bit 8 = Parameters out of range error	RO	0
1016	Cold junction temperature (degrees.tenths)	RO	-
1017	Start / Stop 0 = Controller in STOP 1 = Controller in START	R/W	0
1018	Lock conversion ON / OFF 0 = Lock conversion OFF 1 = Lock conversion ON	R/W	0
1019	Tune management for regulation loop 1 With automatic Tune (par. 83 E_{MIN} , $t = \text{Auto}$): 0 = autotuning function OFF 1 = autotuning ON With manual Tune (par. 83 E_{MIN} , $t = \text{MANU. o ANCE}$): 0 = autotuning function OFF 1 = autotuning ON With synchronized Tune (par. 83 E_{MIN} , $t = \text{SYNCH}$): 0 = autotuning function OFF 1 = command output OFF (forces the cooling) 2 = command output ON (forces the heating) 3 = autotuning ON 4 = autotuning ended	RO R/W R/W	0 0 0
1020	Automatic/manual selection 0 = automatic	R/W	0
1021	OFF LINE* time (milliseconds)	R/W	0

1022	Digital inputs status (0 = not active, 1 = active) Bit0 = Ingresso dig. 1 Bit2 = Ingresso dig. 3 Bit1 = Ingresso dig. 2 Bit3 = Ingresso dig. 4	RO	0
1023	Current CT instantaneous (Ampere with tenth)	RO	0
1024	Current CT ON (Ampere with tenth)	RO	0
1025	Current CT OFF (Ampere with tenth)	RO	0
1100	Process with decimal point selection	RO	0
1101	Setpoint 1 with decimal point selection	R/W	EEPROM
1102	Setpoint 2 with decimal point selection	R/W	EEPROM
1103	Setpoint 3 with decimal point selection	R/W	EEPROM
1104	Setpoint 4 with decimal point selection	R/W	EEPROM
1105	Alarm 1 with decimal point selection	R/W	EEPROM
1106	Alarm 2 with decimal point selection	R/W	EEPROM
1107	Alarm 3 with decimal point selection	R/W	EEPROM
1108	Alarm 4 with decimal point selection	R/W	EEPROM
1109	Gradient Setpoint with decimal point selection	RO	EEPROM
1110	Percentage heating output (0-1000)	R/W	0
1111	Percentage heating output (0-100)	R/W	0
1112	Percentage cooling output (0-1000)	RO	0
1113	Percentage cooling output (0-100)	RO	0
5000	Start/Stop	WO	-
5001	Value of remote setpoint by command 1 serial	R/W	0

* If value is 0, the control is disabled. If different from 0, it is the max. time which can elapse between two pollings before the controller goes off-line. If it goes off-line, the controller returns to Stop mode, the control output is disabled but the alarms are active.

11 Reading and configuration through NFC

	 <p>Programmable via RFID /NFC. No wiring required!</p>	 <p>Scan the Qr-Code to download the App on Google Play Store®</p>
---	--	--

The controller is supported by the App MyPixsys: using an ANDROID smartphone with NFC connection it is possible to program the device without using a dedicated equipment. The App allows to read, set and backup all parameters which are stored into the internal memory of Pixsys devices.

Procedure:

- Identify the position of the NFC antenna on the smartphone (usually central, behind the back cover) or to one of the sides in case of metal chassis. The controller's antenna is placed on the frontal panel, under the function keys.
- Make sure that the NFC sensor of the phone is enabled or that there are no metal materials between the phone and the device (ex. aluminium cover or with magnetic stand)
- It is useful to enable the system sounds on the smartphone, as the notification sound confirms that the device has correctly been detected.

The App interface is provided with four tabs: SCAN, DATA, WRITE, EXTRA.

Select the first tab "SCAN" to read data stored into the internal memory of the device; place the smartphone in contact with the controller frontal panel, making sure that the phone's antenna matched with that of the controller.

Once detected the device, the App emits a notification sounds and proceeds with the model identification and the reading of the parameters.

The graphic interface shows the advancement and switches to the second tab "DATA". It is now possible to move the smartphone away from the controller to make the required modifications more easily.

The device parameters are divided into collapsible groups and are displayed with name, current value and reference index to the manual. Click on a row to open the setting screen of the related parameter with the detailed view of available options (in case of multiple choice parameters) or of the minimum/maximum/decimals limits (for numeric parameters), included the text description (as per section n. 11 of the user manual). Once selected the chosen value, the related row will be updated and underlined into the tab "DATA" (hold down the line to cancel modifications).

To download the new configuration on your device, select the third tab "WRITE", place again the smartphone in contact with the controller and wait for the notification.

The ATR244 will show a restart request, necessary to update the configuration with the new written modifications; if it does not restart, the controller will continue to work with the previous configuration. In addition to the classic operation of parameters reading->modification->writing, MyPixsys is provided with additional functions which can be accessed by the tab "EXTRA", as save parameters / e-mail loaded values/ restore default values.

11.1 Configuration through memory card

The device can be configured through a memory card (2100.30.013). This one is linked to the micro-USB connector on the bottom of the device.

11.2 Memory card creation/update



In order to save a parameter configuration in the memory card, connect it to micro-USB connector and power the instrument. If the memory has never been configured, the device starts normally, but if its data are considered valid, it is possible to view on the display *MEMO 5k:P*. Press **SET** in order to start the product without uploading any data from the memory card. Configure, set the parameters and exit configuration. Now, the device saves the configuration just created also in the memory.

11.3 Configuration loading from memory card













In order to charge a configuration previously created and saved in the memory card, connect it to the micro-USB connector and power the instrument. Now, if the memory is detected and its data are considered valid, it is possible to view on the display *MEMO 5k:P*. By pressing **▲** you see *MEMO Load* and with **SET** you confirm the uploading of parameters from the memory card to the controller. If, on the other hand, you press directly **SET**, when viewing *MEMO 5k:P*, the product starts without uploading any data from the memory card.

12 Loading default values

This procedure allows to restore factory settings of the device.

	Press	Display	Do
1	FNC for 3 sec	Display 1 shows <i>PRSS</i> , while display 2 shows <i>0000</i> with the 1st digit flashing.	
2	▲ or ▼	Modify the flashing digit and move to the next one pressing SET .	Enter password <i>9999</i> .
3	FNC to confirm	The device loads default settings and restarts.	

13 Access configuration

	Press	Display	Do
1	FNC for 3 sec.	Display 1 shows <i>PASS.</i> , while display 2 shows <i>0000</i> with the 1st digit flashing.	
2	 	Modify flashing digit and move to next digit with SET .	Enter password <i>1234</i> .
3	FNC to confirm	Display 1 shows the name of first parameters group, display 2 shows the description.	
4	 or 	Scroll parameters groups.	
5	SET to confirm	Display 1 shows the name of the group first parameter, display 2 shows the number of parameter and display 3 shows its value.	Press FNC to exit configuration.
6	 or 	Scroll parameters.	
7	SET to confirm	Allows parameter modification (display 3 flashes)	
8	 or 	Increases or decreases visualized value  	Introduce new data
9	SET	Confirms and stores the new value. If the value is different from default values, the arrow keys light on.	
10	FNC	Backs to parameter groups selection (see point 3).	Press again FNC to exit configuration

13.1 Parameters list functioning

The controller integrates many features that make the configuration parameters list very long. To make it more functional, the parameters list is dynamics and it changes as the user enables / disables the functions. Practically, using a specific function that occupies a given input (or output), the parameters referred to other functions of that resource are hidden to the user making the parameters list more concise.

To simplify the reading/interpretation of the parameters, pressing **SET** it is possible to visualize a brief description of the selected parameter.

Finally, keeping pressed **FNC**, it is possible to move from the mnemonic visualization of the parameter to the numeric one, and vice versa. Ex. The first parameter can be displayed as *SEn.1* (mnemonic visualization) or as *P.001* (numeric visualization).

Set the product parameters so that they are suitable for the system to be controlled. If they are not suitable, unexpected operations may occasionally cause materials damage or accidents.

14 Table of configuration parameters

GROUP A1 - R_{LIN} - Analogue input 1

1 SEN Sensor A11

Analogue input configuration / sensor A11 selection

EC	K	Tc-K	-260° C..1360° C. (Default)
EC	S	Tc-S	-40° C..1760° C
EC	R	Tc-R	-40° C..1760° C
EC	J	Tc-J	-200° C..1200° C
EC	t	Tc-T	-260° C..400° C
EC	E	Tc-E	-260° C..980° C
EC	N	Tc-N	-260° C..1280° C
EC	b	Tc-B	100° C..1820° C
$Pt100$		Pt100	-200° C..600° C
$Ni100$		Ni100	-60° C..180° C
$Ni120$		Ni120	-60° C..240° C
Ntc	1	NTC 10K β 3435K	-40° C..125° C
Ntc	2	NTC 10K β 3694K	-40° C..150° C
Ntc	3	NTC 2252 β 3976K	-40° C..150° C
Ptc		PTC 1K	-50° C..150° C
$Pt500$		Pt500	-200° C..600° C
$Pt1k$		Pt1000	-200° C..600° C
$PSvd$	1	Reserved	
$PSvd$	2	Reserved	
$0-1$		0..1 V	
$0-5$		0..5 V	
$0-10$		0..10 V	
$0-20$		0..20 mA	
$4-20$		4..20 mA	
$0-60$		0..60 mV	
Pot		Potentiometer (set the value on parameter 6)	

2 dP Decimal Point 1

Select number of displayed decimal points for A11

0	Default
0.0	1 decimal
0.00	2 decimals
0.000	3 decimals

3 $dEGr$ Degree

$^{\circ}C$	Celsius (Default)
$^{\circ}F$	Fahrenheit
K	Kelvin

4 LL Lower Linear Input A11

A11 lower limit only for linear signals. Ex.: with input 4..20 mA this parameter takes value associated to 4 mA. The value may be greater than the one entered on the next parameter.

-9999..+30000 [digit]^[p. 94] **Default:** 0.

5 UL Upper Linear Input A11

A11 upper limit only for linear signals Ex: with input 4..20 mA this parameter takes value associated to 20 mA. The value may be lower than the one entered on the previous parameter.

-9999..+30000 [digit]^[p. 94] **Default:** 1000

6 P.A1 Potentiometer Value A1

Selects the value of the potentiometer connected on A1
1..150 kohm. **Default:** 10kohm

7 L.A1 Linear Input over Limits A1

If A1 is a linear input, allows to the process to overpass the limits (parameters 4 and 5)

d.SRb. Disabled (**Default**)

ENRb. Enabled

8 L.C.E1 Lower Current Error 1

If A1 is a 4-20 mA input, it determines the current value below the probe error E-05 is signaled.

2.0 mA (**Default**)

2.5 mA

3.2 mA

3.8 mA

2.2 mA

2.8 mA

3.4 mA

2.4 mA

3.0 mA

3.6 mA

9 o.c.R1 Offset Calibration A1

A1 Offset calibration. Value added/subtracted to the process value (ex: usually correcting the ambient temperature value).

-9999..+9999 [digit^{1 p.94}] (degrees.tenths for temperature sensors). **Default** 0.

10 G.c.R1 Gain Calibration A1

Value multiplied to the process value to calibrate the working point. Ex: to correct the range from 0..1000°C showing 0..1010°C, set the parameter to -1.0

-100.0%..+100.0%, **Default:** 0.0.

11 L.L.c.1 Latch-On A1

Automatic setting of limits for A1 linear input

d.SRb. Disabled (**Default**)

SEMRd Standard

V.0.5Eo. Virtual Zero Stored

V.0.k.oN. Virtual Zero at start

12 c.F.L1 Conversion Filter A1

ADC Filter: Number of sensor readings to calculate mean that defines process value.

NB: When readings increase, control loop speed slows down.

1..15. (**Default:** 10)

13 c.Fr.1 Conversion Frequency A1

Sampling frequency of digital / analogue converter for A1.

Increasing the conversion speed will slow down reading stability

(example: for fast transients, as the pressure, it is advisable to increase sampling frequency).

4.17.HZ 4.17 Hz (Min. conversion speed)

39.0HZ 39.0 Hz

6.25HZ 6.25 Hz

50.0HZ 50.0 Hz

8.33HZ 8.33 Hz

62.0HZ 62.0 Hz

10.0HZ 10.0 Hz

123HZ 123 Hz

12.5HZ 12.5 Hz

242HZ 242 Hz

16.7HZ 16.7 Hz (**Default**) Ideal for noises filtering 50 / 60 Hz

470HZ 470 Hz (Max. speed conversion)

19.6HZ 19.6 Hz

33.2HZ 33.2 Hz

14÷18 Reserved Parameters - Group A1

Reserved parameters - Group **A1**

GROUP A2 - \overline{A}_{1n2} - Analogue input 2 (only on ATR444-2xABC-X)

19 \overline{SE}_{n2} Sensor AI2

Analogue input configuration / sensor AI2 selection

d_{5Rb} .	Disabled	Disabled. (Default)
$t_c. K$	Tc-K	-260° C..1360° C
$t_c. S$	Tc-S	-40° C..1760° C
$t_c. R$	Tc-R	-40° C..1760° C
$t_c. J$	Tc-J	-200° C..1200° C
$t_c. t$	Tc-T	-260° C..400° C
$t_c. E$	Tc-E	-260° C..980° C
$t_c. N$	Tc-N	-260° C..1280° C
$t_c. b$	Tc-B	100° C..1820° C
$Pt100$	Pt100	-200° C..600° C
$Ni100$	Ni100	-60° C..180° C
$Ni120$	Ni120	-60° C..240° C
$Ntc 1$	NTC 10K β 3435K	-40° C..125° C
$Ntc 2$	NTC 10K β 3694K	-40° C..150° C
$Ntc 3$	NTC 2252 β 3976K	-40° C..150° C
Ptc	PTC 1K	-50° C..150° C
$Pt500$	Pt500	-200° C..600° C
$Pt1k$	Pt1000	-200° C..600° C
$RSvd.1$	Reserved	
$RSvd.2$	Reserved	
$0-1$	0..1 V	
$0-5$	0..5 V	
$0-10$	0..10 V	
$0-20$	0..20 mA	
$4-20$	4..20 mA	
$0-60$	0..60 mV	
$Pot.$	Potentiometer (set the value on parameter 24)	

20 $dP.2$ Decimal Point 2

Select number of displayed decimal points for AI 2

0	Default
0.0	1 decimal
0.00	2 decimals
0.000	3 decimals

21 $rES.$ Reserved

Reserved parameter

22 $LL.12$ Lower Linear Input AI2

AI2 lower limit only for linear signals. Ex.: with input 4..20 mA this parameter takes value associated to 4 mA. The value may be greater than the one entered on the next parameter.

-9999..+30000 [digit^[p.94]] **Default:** 0.

23 $UL.12$ Upper Linear Input AI2

AI2 upper limit only for linear signals Ex: with input 4..20 mA this parameter takes value associated to 20 mA. The value may be lower than the one entered on the previous parameter.

-9999..+30000 [digit^[p.94]] **Default:**1000

24 P_{AI2} Potentiometer Value AI2

Selects the value of the potentiometer connected on AI2

1..150 kohm. Default: 10kohm

25 *i.o.L2* Linear Input over Limits AI2

If AI2 is a linear input, allows to the process to overpass the limits (parameters 22 and 23)

d.i5Rb. Disabled (**Default**)

ENRb. Enabled

26 *L.c.E2* Lower Current Error 2

If AI2 is a 4-20 mA input, it determines the current value below the probe error E-06 is signaled.

2.0 mA (**Default**) *2.5 mA* *3.2 mA* *3.8 mA*

2.2 mA *2.8 mA* *3.4 mA*

2.4 mA *3.0 mA* *3.6 mA*

27 *o.c.R2* Offset Calibration AI2

AI2 Offset calibration. Value added/subtracted to the process value (ex: usually correcting the ambient temperature value).

-9999..+9999 [digit^{1p.9d}] (degrees.tenths for temperature sensors). **Default** 0.

28 *G.c.R2* Gain Calibration AI2

Value multiplied to the process value to calibrate the working point. Ex: to correct the range from 0..1000°C showing 0..1010°C, set the parameter to -1.0

-100.0%..+100.0%, **Default**: 0.0.

29 *Lt.c.2* Latch-On AI2

Automatic setting of limits for AI2 linear input

d.i5Rb. Disabled (**Default**)

5ENRd Standard

V.0.5Eo. Virtual Zero Stored

V.0.k.oN Virtual Zero at start

30 *c.F.L2* Conversion Filter AI2

ADC Filter: Number of sensor readings to calculate mean that defines process value. **NB**: When readings increase, control loop speed slows down.

1..15. (**Default**: 10)

31 *c.F.r.2* Conversion Frequency AI2

Sampling frequency of digital / analogue converter for AI2.

Increasing the conversion speed will slow down reading stability

(example: for fast transients, as the pressure, it is advisable to increase sampling frequency).

4.17.HZ 4.17 Hz (Min. conversion speed) *39.0HZ* 39.0 Hz

6.25HZ 6.25 Hz *50.0HZ* 50.0 Hz

8.33HZ 8.33 Hz *62.0HZ* 62.0 Hz

10.0HZ 10.0 Hz *123HZ* 123 Hz

12.5HZ 12.5 Hz *242HZ* 242 Hz

16.7HZ 16.7 Hz (**Default**) Ideal for filtering *470HZ* 470 Hz (Max. speed conversion)
noises 50 / 60 Hz

19.6HZ 19.6 Hz

33.2HZ 33.2 Hz

32÷36 Reserved Parameters - Group A2

Reserved parameters - Group **A2**

GROUP B1 - *cmd.1* - Outputs and regulation Process 1

37 *c.o.u.1* Command Output 1

- Selects the command output related to the process1 and the outputs related to the alarms.
- c. o3* Command on relay output Q3.
 - c. o1* Command on relay output Q1. **(Default)**
 - c. SSR* Command on digital output
 - c. VRL* Servo-valve command with open loop on Q1 (6-4 open; 6-5 close).
 - c. 0-10* Command 0-10 V on analogue output AO1
 - c. 4-20* Command 4-20 mA on analogue output AO1.
 - 0.10.5.P.* Command 0-10 V on analogue output AO1 with split-range function: the analogue output sets the cooling action from 0 to 5V and heating action from 5 to 10V.
 - 4.20.5.P.* Command 4-20 mA on analogue output AO1 with split-range function: the analogue output sets the cooling action from 4 to 12mA and heating action from 12 to 20mA.

ATR444-13ABC

	Command	AL. 1	AL. 2	AL. 3	AL. 4	AL. 5
<i>c. o3</i>	Q3	Q1	Q2	DO1	DO2	AO1
<i>c. o1</i>	Q1	Q2	Q3	DO1	DO2	AO1
<i>c. SSR</i>	DO1	Q1	Q2	Q3	DO2	AO1
<i>c. VRL</i>	Q1	Q2	Q3	DO1	DO2	AO1
<i>c. 0-10 (0.10.5.P.)</i>	AO1 (0..10 V)	Q1	Q2	Q3	DO1	DO2
<i>c. 4-20 (4.20.5.P.)</i>	AO1 (4..20 mA)	Q1	Q2	Q3	DO1	DO2

ATR444-14ABC-T

	Command	AL. 1	AL. 2	AL. 3	AL. 4	AL. 5	AL. 6
<i>c. o3</i>	Q3	Q1	Q2	Q4	DO1	DO2	AO1
<i>c. o1</i>	Q1	Q2	Q3	Q4	DO1	DO2	AO1
<i>c. SSR</i>	DO1	Q1	Q2	Q3	Q4	DO2	AO1
<i>c. VRL</i>	Q1	Q2	Q3	Q4	DO1	DO2	AO1
<i>c. 0-10 (0.10.5.P.)</i>	AO1 (0..10 V)	Q1	Q2	Q3	Q4	DO1	DO2
<i>c. 4-20 (4.20.5.P.)</i>	AO1 (4..20 mA)	Q1	Q2	Q3	Q4	DO1	DO2

ATR444-15ABC

	Command	AL. 1	AL. 2	AL. 3	AL. 4	AL. 5	AL. 6
<i>c. o3</i>	Q3	Q1	Q2	Q4	Q5	DO1	DO2
<i>c. o1</i>	Q1	Q2	Q3	Q4	Q5	DO1	DO2
<i>c. SSR</i>	DO1	Q1	Q2	Q3	Q4	Q5	DO2
<i>c. VRL</i>	Q1	Q2	Q3	Q4	Q5	DO1	DO2

ATR444-22ABC

	Command	AL. 1	AL. 2	AL. 3	AL. 4
<i>c. o1</i>	Q1	Q2	DO1	DO2	AO1
<i>c. SSR</i>	DO1	Q1	Q2	DO2	AO1
<i>c. VRL</i>	Q1	Q2	DO1	DO2	AO1
<i>c. 0-10 (0.10.5.P.)</i>	AO1 (0..10 V)	Q1	Q2	DO1	DO2
<i>c. 4-20 (4.20.5.P.)</i>	AO1 (4..20 mA)	Q1	Q2	DO1	DO2

ATR444-24ABC-T

	Command	AL. 1	AL. 2	AL. 3	AL. 4	AL. 5	AL. 6	AL. 7
<i>c. o3</i>	Q3	Q1	Q2	Q4	DO1	DO2	AO1	AO2
<i>c. o1</i>	Q1	Q2	Q3	Q4	DO1	DO2	AO1	AO2
<i>c. SSR</i>	DO1	Q1	Q2	Q3	Q4	DO2	AO1	AO2
<i>c. VRL</i>	Q1	Q2	Q3	Q4	DO1	DO2	AO1	AO2
<i>c. 0-10 (0.10.5.P.)</i>	AO1 (0..10 V)	Q1	Q2	Q3	Q4	DO1	DO2	AO2
<i>c. 4-20 (4.20.5.P.)</i>	AO1 (4..20 mA)	Q1	Q2	Q3	Q4	DO1	DO2	AO2

NB: if an output is used for functions other than alarms (for example retransmission or command n° 2), this resource will no longer be available as an alarm and the related group will be hidden from the parameter list. The correspondence of the functions/outputs remains however that indicated in the tables above.

38 *cPr.1* **Command Process 1** (only on ATR444-2xABC-X)

- Selects process value related to process 1 and to command output 1.
- R.IN.1* Value read on input AI1. **(Default)**
- R.IN.2* Value read on input AI2.
- MER1* Arithmetic average of the value read on inputs AI1 and AI2 $[(AI1-AI2)/2]$.
- dIFF.* Difference of the values read on inputs AI1 and AI2 $(AI1-AI2)$.
- Ab.dIF.* Module of the difference of the values read on inputs AI1 and AI2 $(|AI1-AI2|)$.
- SUM* Sum of values read on inputs AI1 and AI2 $(AI1+AI2)$.
- HIGH.* Greater value between AI1 and AI2
- LOWER* Lower value between AI1 and AI2
- REDUM.* Value read on AI1 or value read on AI2 if AI1 is in error (E-05)

39 *rES.* **Reserved**

Reserved parameter

40 *AcT.1* **Action type 1**

- Action type to control process 1.
- HEAT* Heating (N.A.) **(Default)**
- COOL* Cooling (N.C.)

41 *cHY.1* **Command Hysteresis 1**

Hysteresis to control process 1 in ON/OFF
 -9999..+9999 [digit^{1 p.94}] (degrees.tenths for temperature sensors). **Default** 0.2.

42 *LLS.1* **Lower Limit Setpoint 1**

Lower limit setpoint selectable for command setpoint 1
 -9999..+30000 [digit^{1 p.94}] (degrees for temperature sensors). **Default** 0.

43 *ULS.1* **Upper Limit Setpoint 1**

Upper limit setpoint selectable for command setpoint 1
 -9999..+30000 [digit^{1 p.94}] (degrees for temperature sensors). **Default** 1750.

44 *c.rE.1* **Command Reset 1**

- Type of reset for command contact 1 (always automatic in PID functioning)
- R. RES.* Automatic Reset **(Default)**
- M. RES.* Manual Reset (by keyboard or by digital input)
- M.RES.S.* Manual Reset Stored (keeps relay status also after an eventual power failure)
- R.RES.t.* Automatic reset with timed activation. The command remains active for the time set on the parameter 48 *c.dE.t.*, even if the conditions generating it are missing. To be able to act again, the conditions for activating the command must disappear.

45 *cSE.1* Command State Error 1

State of contact for command 1 output in case of error.

If the command output 1 (Par. 37 *c.Ou.1*) is relay or valve:

aPEN Contact or valve open. **Default**

cLoSE Contact or valve closed.

If the command output 1 is digital output (SSR):

aFF Digital output OFF. **Default**

aM Digital output ON.

If the command output 1 is 0-10V:

0 V 0 V. **Default**

10 V 10 V.

If the command output 1 is 0-20 mA:

0 mA 0 mA. **Default**

4 mA 4 mA.

20 mA 20 mA.

21.5mA 21.5 mA.

46 *cSS.1* Command State Stop 1

State of contact for command output 1 with controller in STOP

If the command output 1 (Par. 37 *c.Ou.1*) is relay or valve:

aPEN Contact or valve open. **Default**

cLoSE Contact or valve closed.

If the command output 1 is digital output (SSR):

aFF Digital output OFF. **Default**

aM Digital output ON.

If the command output 1 is 0-10V:

0 V 0 V. **Default**

10 V 10 V.

If the command output 1 is 0-20 mA:

0 mA 0 mA. **Default**

4 mA 4 mA.

20 mA 20 mA.

21.5mA 21.5 mA.

47 *cLd.1* Command Led 1

Defines led C1 state corresponding to the relevant output. If the valve command is selected, this parameter is not managed.

a.c. ON with open contact or SSR switched off. If command AO1, ON with output 0%, OFF if 100% and flashing between 1% and 99%.

c.c. ON with closed contact or SSR switched on. If command AO1 ON with output 100%, OFF if 0% and flashing between 1% and 99%. (**Default**)

48 *c.dE.1* Command Delay 1

Command 1 delay (only in ON / OFF functioning).

-60:00..60:00 mm:ss. **Default:** 00:00.

Negative value: delay when turning off output.

Positive value: delay when turning on output.

49 *cS.P.1* Command Setpoint Protection 1

Allows or not to modify command setpoint 1 value

FPRE Modification allowed (**Default**)

LoCK Protected

50 *VALT.1* **Valve Time 1**

Valve time related to command 1 (declared by the manufacturer of the valve)
1...300 seconds. **Default:** 60.

51 *VF.P.* **Valve Feedback Potentiometer** (*only on ATR444-2xABC-X*)

Enables the reading of feedback potentiometer for motorized valves on input AI2
By setting *PO.CAL.*, when exit configuration, valve will be open and then completely closed to allow the controller to store feedback potentiometer limits.

DISRB. Disabled (**Default**)

ENRB. Enabled

PO.CAL. (Potentiometer Calibration). Back to *ENRB.* when the procedure ends.

52 *S.V.S.1* **State Valve Saturation 1**

Select the valve status when the output percentage is 100%

PERC. The valve opening relay is activated for a time equal to 5% of the valve time

FxEd The valve opening relay is always active

53 *A.M.A.1* **Automatic / Manual 1**

Enables the automatic/manual selection for command 1

DISRB. Disabled (**Default**)

ENRB. Enabled

EN.5EM. Enabled with memory

54 *L.P.R.1* **Load Power Rating 1**

Defines the power rating of the load (in kW) connected to the command output 1, to calculate the energy consumed by the system.

0.0..1000.0 kW. **Default:** 0.0 kW

55 *IN.IS.* **Initial State**

Choose the state of the controller when turning it on. This only works on the RS485 version or by enabling the Start/Stop from digital input or function button.

START Start (**Default**)

STOP Stop

STORE. Stored. State of Start/Stop prior to switching off.

56÷59 **Reserved Parameters - Group B1**

Reserved parameters - Group B1

GROUP B2 - $c\pi d_2$ - Outputs and regul. Process 2 (only on ATR444-2xABC-X)

60 $c.o.u.2$ Command Output 2

Selects the command output related to the process 2

NB: refer to the function/output table of parameter 37 $c.o.u.1$ to check which resources will remain available after changing this parameter (eg: setting $c.o.u.2$ as $c.55P$, it will no longer be possible to enable the alarm associated with the DO2 output).

- $d.5Rb.$ Command disabled. **(Default)**
- $c. o4$ Command on relay output Q4
- $c. o2$ Command on relay output Q2
- $c. 55P$ Command on digital output DO2
- $c. VRL.$ Servo-valve command with open loop
- $c.0-10$ Command 0-10 V on analogue output AO2
- $c.4-20$ Command 4-20 mA on analogue output AO2
- $0.10.5.P.$ Command 0-10 V on analogue output AO2 with split-range function: the analogue output sets the cooling action from 0 to 5V and heating action from 5 to 10V.
- $4.20.5.P.$ Command 4-20 mA on analogue output AO2 with split-range function: the analogue output sets the cooling action from 4 to 12mA and heating action from 12 to 20mA.

ATR444-22ABC	Command
$d.5Rb$	-
-	-
$c. o2$	Q2
$c. 55P$	DO2
$c. VRL.$	DO1(open)-DO2(close)

ATR444-24ABC-T	Command
$d.5Rb$	-
$c. o4$	Q4
$c. o2$	Q2
$c. 55P$	DO2
$c. VRL.$	Q2(open)-Q4(close)
$c.0-10 (0.10.5.P.)$	AO2 (0..10 V)
$c.4-20 (4.20.5.P.)$	AO2 (4..20 mA)

61 $c.Pr.2$ Command Process 2

Selects process value related to process 2 and to command output 2.

- $R.in.1$ Value read on input AI1. **(Default)**
- $R.in.2$ Value read on input AI2.
- $MERN$ Arithmetic average of the value read on inputs AI1 and AI2 $[(AI1-AI2)/2]$.
- $d.FF.$ Difference of the values read on inputs AI1 and AI2 $(AI1-AI2)$.
- $Rb.d.F.$ Module of the difference of the values read on inputs AI1 and AI2 $(|AI1-AI2|)$.
- SUM Sum of values read on inputs AI1 and AI2 $(AI1+AI2)$.
- $HiGH.$ Greater value between AI1 and AI2
- $LoWER$ Lower value between AI1 and AI2
- $REduM.$ Value read on AI1 or value read on AI2 if AI1 is in error (E-05)

62 $c.EN5.$ Remote Setpoint

Enables remote setpoint. The control setpoint is sent by another device and is received by a second analogue input (it is necessary to select on parameter $c.Pr.2$ the selections $R.in.1$ or $R.in.2$) or through serial.

- $d.5Rb.$ Disabled. **(Default)**
- $ENRb.$ Enables remote setpoint by process 2. Remote/local selection can be done by digital input.
- $EN.kSt.$ Remote setpoint by process 2, Remote/local selection only by keyboard (not allowed by digital input)
- $EN.SER.$ Enables remote setpoint by serial input. Remote/local selection can be done by digital input.
- $EN.SE.k.$ Remote setpoint by serial, Remote/local selection only by keyboard (not allowed by digital input).
- $c\pi d. 1$ The reference setpoint of command 2 is the same of command 1.

- 63** *A_c.E₂* **Action type 2**
 Action type to control process 2.
HEAT Heating (N.A.) (**Default**)
COOL Cooling (N.C.)
- 64** *c.H₂* **Command Hysteresis 2**
 Hysteresis to control process 2 in ON/OFF.
 -9999..+9999 [digit^{1 p.94}] (degrees.tenths for temperature sensors). **Default** 0.2.
- 65** *LLS₂* **Lower Limit Setpoint 2**
 Lower limit setpoint selectable for command setpoint 2.
 -9999..+30000 [digit^{1 p.94}] (degrees for temperature sensors). **Default** 0.
- 66** *ULS₂* **Upper Limit Setpoint 2**
 Upper limit setpoint selectable for command setpoint 2.
 -9999..+30000 [digit^{1 p.94}] (degrees for temperature sensors). **Default** 1750.
- 67** *c.r.E₂* **Command Reset 2**
 Type of reset for command contact 2 (always automatic in PID functioning)
R.PES. Automatic Reset (**Default**)
M.PES. Manual Reset (by keyboard or by digital input)
M.PES.S. Manual Reset Stored (keeps relay status also after an eventual power failure)
R.PES.t. Automatic reset with timed activation. The command remains active for the time set on the parameter 71 *c.dE.2.*, even if the conditions generating it are missing. To be able to act again, the conditions for activating the command must disappear.
- 68** *c.S.E₂* **Command State Error 2**
 State of contact for command 2 output in case of error.
If the command output 2 (Par. 60 *c.o.u.2*) is relay or valve:
aPEN Contact or valve open. **Default**
cLoSE Contact or valve closed.
If the command output 2 is digital output (SSR):
aFF Digital output OFF. **Default**
aM Digital output ON.
If the command output 2 is 0-10V:
0 V 0 V. **Default**
10 V 10 V.
If the command output 2 is 0-20 mA or 4-20 mA:
0 mA 0 mA. **Default**
4 mA 4 mA.
20 mA 20 mA.
21.5 mA 21.5 mA.
- 69** *c.SS₂* **Command State Stop 2**
 State of contact for command output 2 with controller in STOP
 If the command output 2 (Par. 60 *c.o.u.2*) is relay or valve:
aPEN Contact or valve open. **Default**
cLoSE Contact or valve closed.
 If the command output 2 is digital output (SSR):
aFF Digital output OFF. **Default**
aM Digital output ON.
 If the command output 2 is 0-10V:
0 V 0 V. **Default**
10 V 10 V.
 If the command output 1 is 0-20 mA:

0 mA	0 mA. Default
4 mA	4 mA.
20 mA	20 mA.
21.5 mA	21.5 mA.

70 c.Ld2 Command Led 2

Defines led **C2** state corresponding to the relevant output. If the valve command is selected, this parameter is not managed.

- a.c. ON with open contact or SSR switched off. If command AO2, ON with output 0%, OFF if 100% and flashing between 1% and 99%.
- c.c. ON with closed contact or SSR switched on. If command AO2 ON with output 100%, OFF if 0% and flashing between 1% and 99%. (**Default**)

71 c.dE2 Command Delay 2

Command 2 delay (only in ON / OFF functioning).

-60:00..60:00 mm:ss. **Default:** 00:00.

Negative: delay when turning off output.

Positive: delay when turning on output.

72 c.S.P2 Command Setpoint Protection 2

Allows or not to modify command setpoint 2 value

FPEE Modification allowed (**Default**)

Lack Protected

73 v.R.t2 Valve Time 2

Valve time related to command 2 (declared by the manufacturer of the valve)

1...300 seconds. **Default:** 60.

74 r.E5 Reserved

Reserved parameter

75 S.v.S2 State Valve Saturation 2

Select the valve 2 status when the output percentage is 100%

PEPE The valve opening relay is activated for a time equal to 5% of the valve time

FixEd The valve opening relay is always active

76 A.A.R2 Automatic / Manual 2

Enables the automatic/manual selection for command 2

d.SAb. Disabled (**Default**)

EMAb. Enabled

EM.SAb. Enabled with memory

77 L.P.r2 Load Power Rating 2

Defines the power rating of the load (in kW) connected to the command output 2, to calculate the energy consumed by the system

0.0..1000.0 kW. **Default:** 0.0 kW

78÷82 Reserved Parameters - Group B2

Reserved parameters - Group B2

GROUP C1 - *rEG.1* - Autotuning and PID 1

83 *tun.1* **Tune 1**

Selects autotuning type for command 1

d.5Rb. Disabled. If proportional band and integral time parameters are set to zero, the regulation is ON/OFF type. **(Default)**

RuLo Automatic (Automatic PID parameters calculation)

M#M. Manual (launch by keyboard or by digital input)

a#cE Once (PID parameters calculation only at first start)

S#cH. Synchronized (Autotuning managed by serial)

84 *S.d.t.1* **Setpoint Deviation Tune 1**

Selects deviation from command setpoint 1 as threshold used by autotuning to calculate PID parameters

0-10000 [digit^{1p.9d}] (degrees.tenths for temperature sensors). **Default:** 30.0.

85 *P.b. 1* **Proportional Band 1**

Proportional band or process 1 PID regulation (Process inertia).

0 ON / OFF if *t.i.* equal to 0 **(Default)**

1..10000 [digit^{1p.9d}] (degrees.tenths for temperature sensors).

86 *i.t. 1* **Integral Time 1**

Integral time for process 1 PID regulation (process inertia duration).

0.0...2000.0 sec. (0.0 = integral disabled), **Default** 0.0

87 *d.t. 1* **Derivative Time 1**

Derivative time for process 1 PID regulation (Normally ¼ of integral time).

0.0...1000.0 sec. (0.0 = derivative disabled), **Default** 0

88 *d.b. 1* **Dead Band 1**

Dead band of process 1 PID

0..10000 [digit^{1p.9d}] (degrees.tenths for temperature sensors) **(Default: 0)**

89 *P.b.c.1* **Proportional Band Centered 1**

Defines if the proportional band 1 must be centered or not on the setpoint. In double loop functioning (heating/cooling), always disabled.

d.5Rb. Disabled. Band under (heating) or over (cooling) **(Default)**

E#Rb. Centered band

90 *a.o.S.1* **Off Over Setpoint 1**

In PID enables the command output 1 switching off, when a certain threshold is exceeded (setpoint + Par.91 *a.d.t.1*)

d.5Rb. Disabled **(Default)**

E#Rb. Enabled

91 *a.d.t.1* **Off Deviation Threshold 1**

Selects deviation from command setpoint 1, to calculate the intervention threshold of "Off Over Setpoint 1" function.

-9999..+9999 [digit^{1p.9d}] (degrees.tenths for temperature sensors) **(Default: 0)**

92 *c.t. 1* **Cycle Time 1**

Cycle time for PID regulation of process 1 (for PID on remote control switch 15 s; for PID on SSR 2s).

For valve refer to parameter 50 *uR.t.1*

1-300 seconds **(Default:15 s)**

- 93** *co.F.1* **Cooling Fluid 1**
 Type of refrigerant fluid for heating / cooling PID for process 1. Enable the cooling output on parameter AL.1 ... AL.6.
RiP Air (**Default**)
o.L Oil
WREER Water
- 94** *Pb.1.1* **Proportional Band Multiplier 1**
 Proportional band multiplier for heating/cooling PID for process 1. Proportional band for cooling action is given by parameter *Pb. 1* multiplied for this value
 1.00..5.00. **Default:** 1.00
- 95** *o.d.b.1* **Overlap / Dead Band 1**
 Dead band combination for heating / cooling PID (double action) for process 1.
 -20.0%...50.0%
 Negative: Dead band.
 Positive: overlap. **Default:** 0.0%
- 96** *c.c.t.1* **Cooling Cycle Time 1**
 Cycle time for cooling output in heating / cooling PID mode for process 1.
 1-300 seconds (**Default:**10 s)
- 97** *LLP.1* **Lower Limit Output Percentage 1**
 Selects min. value for command output 1 percentage.
 0%...100%, **Default:** 0%.
- 98** *uL.P.1* **Upper Limit Output Percentage 1**
 Selects max. value for command output 1 percentage.
 0%...100%, **Default:** 100%.
- 99** *Π.G.E.1* **Max Gap Tune 1**
 Selects the max. process-setpoint gap beyond which the automatic tune recalculates PID parameters of process 1.
 8-10000 [digit^{1 p. 94}] (degrees.tenths for temperature sensors). **Default:** 2.0
- 100** *Πn.P.1* **Minimum Proportional Band 1**
 Selects the min. proportional band 1 value selectable by the automatic tune for the PID regulation of process 1.
 0-10000 [digit^{1 p. 94}] (degrees.tenths for temperature sensors). **Default:** 3.0
- 101** *ΠR.P.1* **Maximum Proportional Band 1**
 Selects the max. proportional band 1 value selectable by the automatic tune for the PID regulation of process 1.
 0-10000 [digit^{1 p. 94}] (degrees.tenths for temperature sensors). **Default:** 100.0
- 102** *Πn.i.1* **Minimum Integral Time 1**
 Selects the min. integral time 1 value selectable by the automatic tune for the PID regulation of process 1.
 0.0...1000.0 seconds. **Default:** 30.0 s.

103	d.c.R.1	Derivative Calculation 1
	Determines if, during autotuning, derivative time must be calculated or left at zero.	
	RuLo#. The derivative is forced to zero only if the command is of valve type; in all other cases it is calculated by autotuning. (Default)	
	IERo. The derivative is always forced to zero.	
	eRLc. The derivative is always calculated by autotuning	

104	o.c.L.1	Overshoot Control Level 1	
	The overshoot control function prevents this event during device switching on or when the setpoint is modified.		
	Setting a too low value the overshoot may not be fully absorbed, while with high values the process could reach the setpoint more slowly.		
	d.SRb. LEV. 3	LEV. 6	LEV. 9
	LEV. 1	LEV. 4	LEV. 7
	LEV. 2	LEV. 5 [Default]	LEV. 8

105÷108 Reserved Parameters - Group C1
Reserved parameters - Group C1

GROUP C2 - r.EU.2 - Autotuning and PID 2 *(only on ATR444-2xABC-X)*

109	t.un.2	Tune 2
	Selects autotuning type for command 2	
	d.SRb. Disabled. If proportional band and integral time paramters are to selected to zero, the regulation is ON/OFF type. (Default)	
	RuLo. Automatic (Automatic PID parameters calculation)	
	MRNu. Manual (launch by keyboards or by digital input)	
	oMcE. Once (PID parameters calculation only at first start)	
	SYMcH. Synchronized (Autotuning managed by serial)	

110	S.d.t.2	Setpoint Deviation Tune 2
	Selects deviation from command setpoint 2 as threshold used by autotuning to calculate PID parameters.	
	0-10000 [digit ^{1 p. 94}] (degrees.tenths for temperature sensors). Default: 30.0.	

111	P.b. 2	Proportional Band 2
	Proportional band or process 2 PID regulation (Process inertia).	
	0 ON / OFF if t. r. equal to 0 (Default)	
	1..10000 [digit ^{1 p. 94}] (degrees.tenths for temperature sensors).	

112	i.t. 2	Integral Time 2
	Integral time for process 2 PID regulation (process inertia duration).	
	0.0...2000.0 seconds (0.0 = integral disabled), Default 0.0	

113	d.t. 2	Derivative Time 2
	Derivative time for process 2 PID regulation (Normally ¼ of integral time).	
	0.0...1000.0 seconds (0.0 = derivative disabled), Default 0	

114	d.b. 2	Dead Band 2
	Dead band of process 2 PID	
	0..10000 [digit ^{1 p. 94}] (degrees.tenths for temperature sensors) (Default: 0)	

- 115** *P.b.c.2* **Proportional Band Centered 2**
 Defines if the proportional band 2 must be centered or not on the setpoint. In double loop functioning (heating/cooling), always disabled.
d.SRb. Disabled. Band under (heating) or over (cooling) (**Default**)
ENRb. Centered band
- 116** *o.o.5.2* **Off Over Setpoint 2**
 In PID enables the command output 2 switching off, when a certain threshold is exceeded (setpoint + Par. 117 *o.d.t.2*)
d.SRb. Disabled (**Default**)
ENRb. Enabled
- 117** *o.d.t.2* **Off Deviation Threshold 2**
 Selects deviation from command setpoint 2, to calculate the intervention threshold of "Off Over Setpoint 2" function.
 -9999..+9999 [digit^{1 p. 94}] (degrees.tenths for temperature sensors) (**Default: 0**)
- 118** *c.t. 2* **Cycle Time 2**
 Cycle time for PID regulation of process 2 (for PID on remote control switch 15 s; for PID on SSR 2s). For valve refer to parameter 73 *V.R.t. 2*
 1-300 secondi (**Default:15 s**)
- 119** *co.F.2* **Cooling Fluid 2**
 Type of refrigerant fluid for heating / cooling PID for process 2. Enable the cooling output on parameter AL.1... AL.6.
R.R Air (**Default**)
o.i.L Oil
WATER Water
- 120** *Pb.M.2* **Proportional Band Multiplier 2**
 Proportional band multiplier for heating/cooling PID for process 2. Proportional band for cooling action is given by parameter *Pb. 2* multiplied for this value.
 1.00..5.00. **Default: 1.00**
- 121** *o.d.b.2* **Overlap / Dead Band 2**
 Dead band combination for heating / cooling PID (double action) for process 2. -20.0..50.0%
 Negative: Dead band
 Positive: overlap. **Default: 0.0%**
- 122** *c.c.t.2* **Cooling Cycle Time 2**
 Cycle time for cooling output in heating / cooling PID mode for process 2.
 1-300 seconds (**Default:10 s**)
- 123** *LLP.2* **Lower Limit Output Percentage 2**
 Selects min. value for command output 2 percentage.
 0%...100%, **Default: 0%**.
- 124** *u.L.P.2* **Upper Limit Output Percentage 2**
 Selects max. value for command output 2 percentage.
 0%...100%, **Default: 100%**.
- 125** *P.G.t.2* **Max Gap Tune 2**
 Selects the max. process-setpoint gap beyond which the automatic tune recalculates PID parameters of process 2.
 8-10000 [digit^{1 p. 94}] (degrees.tenths for temperature sensors). **Default: 2.0**

126 *pn.P2* Minimum Proportional Band 2

Selects the min. proportional band value selectable by the automatic tune for the PID regulation of process 2.

0-10000 [digit^{1/p.9d}] (degrees.tenths for temperature sensors). **Default: 3.0**

127 *PR.P2* Maximum Proportional Band 2

Selects the max. proportional band 2 value selectable by the automatic tune for the PID regulation of process 2.

0-10000 [digit^{1/p.9d}] (degrees.tenths for temperature sensors). **Default: 100.0**

128 *pn.i2* Minimum Integral Time 2

Selects the min. integral time 2 value selectable by the automatic tune for the PID regulation of process 2.

0.0...1000.0 sec. **Default: 30.0 sec.**

129 *d.cP2* Derivative Calculation 2

Determines if, during autotuning, derivative time must be calculated or left at zero.

RLcM. The derivative is forced to zero only if the command is of valve type; in all other cases it is calculated by autotuning. **(Default)**

IERD. The derivative is always forced to zero.

cRLc. The derivative is always calculated by autotuning

130 *o.cL2* Overshoot Control Level 2

The overshoot control function prevents this event during device switching on or when the setpoint is modified. Setting a too low value the overshoot may not be fully absorbed, while with high values the process could reach the setpoint more slowly.

<i>dLSRb.</i>	LEV. 3	LEV. 6	LEV. 9
LEV. 1	LEV. 4	LEV. 7	LEV. 10
LEV. 2	LEV. 5 [Default]	LEV. 8	

131÷134 Reserved Parameters - Group C2

Reserved parameters - Group **C2**

GROUP D1 - *AL 1* - Alarm 1

135 *AL.F.* Alarm 1 Function

Alarm 1 selection.

d.5Rb. Disabled (**Default**)

Rb.u.P.R. Absolute Upper Activation. Absolute referred to the process, active over

Rb.Lo.R. Absolute Lower Activation. Absolute referred to the process, active under

bRNd Band alarm (command setpoint \pm alarm setpoint)

R.bRNd Asymmetric band alarm (command setpoint + alarm setpoint 1 H and command setpoint - alarm setpoint 1 L).

u.P.dEV. Upper Deviation. Upper Deviation alarm

Lo.dEV. Lower Deviation. Lower Deviation alarm

Rb.c.u.R. Absolute Command Upper Activation. Absolute alarm referred to the command setpoint, active over

Rb.c.L.R. Absolute Command Lower Activation. Absolute alarm referred to the command setpoint, active under

RuN Status alarm (active in RUN/START)

cool Cold actuator auxiliary (Cold action in double loop)

*c. Ru** Auxiliary for job distribution on the command output. It cyclically replaces the command output for the time set on the parameter 147 *R.i.dE..* If *R.i.dE.* = 0, it is activated parallel to the command output. It does not work in case of valve control and can only be activated on an alarm if *R.i.dE.* is different from 0.

SEEP.R. Step Auxiliary. Auxiliary output related to the step (ON/OFF at each step).

PPb.EP. Probe error. Alarm active in case of sensor rupture.

H.b.R. Heater Break Alarm and Overcurrent Alarm

tMR.1 Related to timer 1

tMR.2 Related to timer 2

tMR.1.2 Related to both timers

F1 Key F1. Alarm is activated / deactivated by pressing the F1 key ^{4 p.94}

F2 Key F2. Alarm is activated / deactivated by pressing the F2 key ^{4 p.94}

F3 Key F3. Alarm is activated / deactivated by pressing the F3 key ^{4 p.94}

F4 Key F4. Alarm is activated / deactivated by pressing the F4 key ^{4 p.94}

d.i. 1 Digital Input 1. Active when digital input 1 is active.

d.i. 2 Digital Input 2. Active when digital input 2 is active.

d.i. 3 Digital Input 3. Active when digital input 3 is active.

d.i. 4 Digital Input 4. Active when digital input 4 is active.

REM. Remote. The alarm is enabled by the word 1243

136 *R.I.P.* Alarm 1 Process (only on ATR444-2xABC-X)

Selects the size related to alarm 1.

R.i.N.1 Value read on input AI1. (**Default**)

R.i.N.2 Value read on input AI2.

MERh Arithmetic average of the value read on inputs AI1 and AI2 $[(AI1+AI2)/2]$.

d.FF. Difference of the values read on inputs AI1 and AI2 $(AI1-AI2)$.

Rb.d.F. Module of the difference of the values read on inputs AI1 and AI2 $(|AI1-AI2|)$.

Sum Sum of values read on inputs AI1 and AI2 $(AI1+AI2)$.

H.GH. Greater value between AI1 and AI2

LoWEP Lower value between AI1 and AI2

REdWN. The value read on AI1 or value read on AI2 if AI1 is in error (E-05)

137 *R.I.R.C.* Alarm 1 Reference Command (only on ATR444-2xABC-X)

Selects alarm 1 reference command

cMd. 1 Alarm referred to command 1. (**Default**)

cMd. 2 Alarm referred to command 2.

138 *RLSo.* Alarm 1 State Output

Alarm 1 output contact and intervention type.

N.o. 5t. (N.O. Start) Normally open, active at start **(Default)**

N.c. 5t. (N.C. Start) Normally closed, active at start

N.o. tH. (N.O. Threshold) Normally open, active on reaching alarm ^{2 p. 94}

N.c. tH. (N.C. Threshold) Normally closed, active on reaching alarm ^{2 p. 94}

N.o. tH.V. (N.O. Threshold Variation) disabled after changing control setpoint ^{3 p. 94}

N.c. tH.V. (N.C. Threshold Variation) disabled after changing control setpoint ^{3 p. 94}

139 *rES.* Reserved

Reserved parameter

140 *RLHY.* Alarm 1 Hysteresis

Alarm 1 hysteresis

-9999..+9999 [digit^{1 p. 94}] (degrees.tenths for temperature sensors). **Default** 0.5.

141 *RLLL.* Alarm 1 Lower Limit

Lower limit selectable for the alarm 1 setpoint.

-9999..+30000 [digit^{1 p. 94}] (degrees for temperature sensors). **Default** 0.

142 *RLUL.* Alarm 1 Upper Limit

Upper limit selectable for the alarm 1 setpoint.

-9999..+30000 [digit^{1 p. 94}] (degrees for temperature sensors). **Default** 1750.

143 *RLrE.* Alarm 1 Reset

Alarm 1 contact reset type (always automatic if *RL.f.F. = c. R_u**).

R. RES. Automatic reset **(Default)**

M. RES. Manual reset (manual reset by keyboard or by digital input)

M.RES.5. Stored manual reset (keeps the output status also after a power failure)

R. RES.t. Automatic reset with timed activation. The alarm remains active for the time set on the parameter 147 *R.f.dE.*, even if the conditions generating it are missing. To be able to act again, the alarm conditions must disappear.

144 *RLSE.* Alarm 1 State Error

Alarm 1 output status in case of error.

oPEN Open contact. **Default**

cLoSE Closed contact.

145 *RLSS.* Alarm 1 State Stop

Alarm 1 output status with the controller in STOP.

RcL.V.R. Alarm active. **Default**

oPEN Open contact.

cLoSE Closed contact.

146 *RLId.* Alarm 1 Led

Defines the status of the led **A1** in correspondence of the relevant output

o.c. ON with open contact or DO switched OFF.

c.c. ON with closed contact or DO switched ON. **(Default)**

147 *RLdE.* Alarm 1 Delay

Alarm 1 Delay.

-60:00..60:00 mm:ss (hh:mm if *RL.f.F. = c. R_u**). **Default**: 00:00.

Negative value: delay when exit alarm status.

Positive value: delay when enter alarm status.

148 *R.15.P.* Alarm 1 Setpoint Protection

	Allows or not to change the alarm 1 setpoint
<i>FREE</i>	Editable by the user (Default)
<i>LOCK</i>	Protected
<i>HiDE</i>	Protected and not visualized

149 *R.1.Lb.* Alarm 1 Label

Selects the message displayed in case of alarm 1 intervention.

<i>d.5Rb.</i>	Disabled. (Default)
<i>Lb. 01</i>	Message 1 (see table paragraph 15.1)
...	
<i>Lb. 20</i>	Message 20 (see table paragraph 15.1)
<i>uSER.L.</i>	Custom message (modifiable by the user through the App or via modbus)

150÷154 Reserved Parameters - Group D1

Reserved parameters - Group D1

GROUP D2 - *AL. 2* - Alarm 2

155 *AL.2.F.* Alarm 2 Function

Alarm 2 selection.

<i>d.5Rb.</i>	Disabled (Default)
<i>Rb.uP.R.</i>	Absolute Upper Activation. Absolute referred to the process, active over
<i>Rb.Lo.R.</i>	Absolute Lower Activation. Absolute referred to the process, active under
<i>bRNd</i>	Band alarm (command setpoint \pm alarm setpoint)
<i>R.bRNd</i>	Asymmetric band alarm (command setpoint + alarm setpoint 2 H and command setpoint - alarm setpoint 2 L).
<i>uP.dEV.</i>	Upper Deviation. Upper Deviation alarm
<i>Lo.dEV.</i>	Lower Deviation. Lower Deviation alarm
<i>Rb.c.u.R.</i>	Absolute Command Upper Activation. Absolute alarm referred to the command setpoint, active over
<i>Rb.c.L.R.</i>	Absolute Command Lower Activation. Absolute alarm referred to the command setpoint, active under
<i>RuN</i>	Status alarm (active in RUN/START)
<i>cooL</i>	Cold actuator auxiliary (Cold action in double loop)
<i>c. Ru*</i>	Auxiliary for job distribution on the command output. It cyclically replaces the command output for the time set on the parameter 167 <i>R.2.dE.</i> . If <i>R.2.dE.</i> = 0, it is activated parallel to the command output. It does not work in case of valve control and can only be activated on an alarm if <i>R.2.dE.</i> is different from 0.
<i>StEP.R.</i>	Step Auxiliary. Auxiliary output related to the step (ON/OFF at each step).
<i>PRb.ER.</i>	Probe error. Alarm active in case of sensor rupture.
<i>H.b.R.</i>	Heater Break Alarm and Overcurrent Alarm
<i>tMR.1</i>	Related to timer 1
<i>tMR.2</i>	Related to timer 2
<i>tMR.1..2</i>	Related to both timers
<i>F1</i>	Key F1. Alarm is activated / deactivated by pressing the F1 key ^{4p.94}
<i>F2</i>	Key F2. Alarm is activated / deactivated by pressing the F2 key ^{4p.94}
<i>F3</i>	Key F3. Alarm is activated / deactivated by pressing the F3 key ^{4p.94}
<i>F4</i>	Key F4. Alarm is activated / deactivated by pressing the F4 key ^{4p.94}
<i>d.i. 1</i>	Digital Input 1. Active when digital input 1 is active.
<i>d.i. 2</i>	Digital Input 2. Active when digital input 2 is active.
<i>d.i. 3</i>	Digital Input 3. Active when digital input 3 is active.
<i>d.i. 4</i>	Digital Input 4. Active when digital input 4 is active.
<i>REM.</i>	Remote. The alarm is enabled by the word 1244

156 *R2P.* **Alarm 2 Process** (only on ATR444-2xABC-X)

Select the size related to alarm 2.

R.N.1 Value read on input AI1. **(Default)**

R.N.2 Value read on input AI2.

MERH Arithmetic average of the value read on inputs AI1 and AI2 $[(AI1+AI2)/2]$.

d.FF. Difference of the values read on inputs AI1 and AI2 $(AI1-AI2)$.

Ab.d.F. Module of the difference of the values read on inputs AI1 and AI2 $(|AI1-AI2|)$.

Sum Sum of values read on inputs AI1 and AI $(AI1+AI2)$.

H.GH. Greater value between AI1 and AI2

LoMHP Lower value between AI1 and AI2

PEdWH. The value read on AI1 or value read on AI2 if AI1 is in error (E-05)

157 *R2r.c.* **Alarm 2 Reference Command** (only on ATR444-2xABC-X)

Selects alarm 2 reference command

cMd. 1 Alarm referred to command 1. **(Default)**

cMd. 2 Alarm referred to command 2.

158 *R2S.o.* **Alarm 2 State Output**

Alarm 2 output contact and intervention type.

N.o. 5E. (N.O. Start) Normally open, active at start **(Default)**

N.c. 5E. (N.C. Start) Normally closed, active at start

N.o. 5H. (N.O. Threshold) Normally open, active on reaching alarm ^{2 p. 94}

N.c. 5H. (N.C. Threshold) Normally closed, active on reaching alarm ^{2 p. 94}

N.o. 5H.V. (N.O. Threshold Variation) disabled after changing control setpoint ^{3 p. 94}

N.c. 5H.V. (N.C. Threshold Variation) disabled after changing control setpoint ^{3 p. 94}

159 *rES.* **Reserved**

Reserved parameter.

160 *R2HY.* **Alarm 2 Hysteresis**

Alarm 2 hysteresis

-9999..+9999 [digit^{1 p. 94}] (degrees.tenths for temperature sensors). **Default** 0.5.

161 *R2LL.* **Alarm 2 Lower Limit**

Lower limit selectable for the alarm 2 setpoint

-9999..+30000 [digit^{1 p. 94}] (degrees for temperature sensors). **Default** 0.

162 *R2UL.* **Alarm 2 Upper Limit**

Upper limit selectable for the alarm 2 setpoint

-9999..+30000 [digit^{1 p. 94}] (degrees for temperature sensors). **Default** 1750.

163 *R2rE.* **Alarm 2 Reset**

Alarm 2 contact reset type (always automatic if *RL.Z.F.* = *c.* *Ru*²).

R. RES. Automatic reset **(Default)**

M. RES. Manual reset (manual reset by keyboard or by digital input)

M.RES.5. Stored manual reset (keeps the output status also after a power failure)

R. RES.5. Automatic reset with timed activation. The alarm remains active for the time set on the parameter 167 *R.Z.dE.*, even if the conditions generating it are missing. To be able to act again, the alarm conditions must disappear.

164 *R25.E.* Alarm 2 State Error

Alarm 2 output status in case of error

If the alarm output is relay

aPEN Contact or open valve. **Default**

cLoSE Contact or closed valve.

If the alarm output is digital (SSR):

aFF Digital output OFF. **Default**

aM Digital output ON.

165 *R25.S.* Alarm 2 State Stop

Alarm 2 output status with controller in STOP

If the alarm output is relay

RcLk.R. Alarm active. **Default**

aPEN Contact or open valve

cLoSE Contact or closed valve

If the alarm output is digital (SSR):

RcLk.R. Alarm active. **Default**

aFF Digital output OFF

aM Digital output ON

166 *R2Ld.* Alarm 2 Led

Defines the status of the led **A2** in correspondence of the relevant output.

a.c. ON with open contact or DO switched off.

c.c. ON with closed contact or DO switched on. (**Default**)

167 *R2.dE.* Alarm 2 Delay

Alarm 2 Delay. -60:00..60:00 mm:ss (hh:mm if *RL.Z.F.* = *c. Ru**). **Default:** 00:00.

Negative value: delay when exit alarm status.

Positive value: delay when enter alarm status

168 *R25.P.* Alarm 2 Setpoint Protection

Allows or not to change the alarm 2 setpoint

FPEE Editable by the user (**Default**)

LoCK Protected

Hi.dE Protected and not visualized

169 *R2Lb.* Alarm 2 Label

Selects the message displayed in case of alarm 2 intervention.

d15Rb. Disabled. (**Default**)

Lb. 01 Message 1 (see table paragraph 15.1)

...

Lb. 20 Message 20 (see table paragraph 15.1)

uSER.L. Custom message (modifiable by the user through the App or via modbus)

170÷174 Reserved Parameters - Group D2

Reserved parameters - Group D2.

GROUP D3 - AL. 3 - Alarm 3

175 AL.3.F. Alarm 3 Function

Alarm 3 selection.

d.5Rb. Disabled (**Default**)

Rb.u.P.R. Absolute Upper Activation. Absolute referred to the process, active over

Rb.Lo.R. Absolute Lower Activation. Absolute referred to the process, active under

bRNd Band alarm (command setpoint ± alarm setpoint)

R.bRNd Asymmetric band alarm (command setpoint + alarm setpoint 3 H and command setpoint - alarm setpoint 3 L)

uP.dEV. Upper Deviation. Upper Deviation alarm

Lo.dEV. Lower Deviation. Lower Deviation alarm

Rb.c.u.R. Absolute Command Upper Activation. Absolute alarm referred to the command setpoint, active over

Rb.c.L.R. Absolute Command Lower Activation. Absolute alarm referred to the command setpoint, active under

RuN Status alarm (active in RUN/START)

cool Cold actuator auxiliary (Cold action in double loop)

*c. Ru** Auxiliary for job distribution on the command output. It cyclically replaces the command output for the time set on the parameter 187 *R.3.dE.* If *R.3.dE.* = 0, it is activated parallel to the command output. It does not work in case of valve control and can only be activated on an alarm if *R.3.dE.* is different from 0.

SEEP.R. Step Auxiliary. Auxiliary output related to the step (ON/OFF at each step).

PPb.ER. Probe error. Alarm active in case of sensor rupture.

H.b.R. Heater Break Alarm and Overcurrent Alarm

tMR.1 Related to timer 1

tMR.2 Related to timer 2

tMR.1.2 Related to both timers

F1 Key F1. Alarm is activated / deactivated by pressing the F1 key ^{4 p. 94}

F2 Key F2. Alarm is activated / deactivated by pressing the F2 key ^{4 p. 94}

F3 Key F3. Alarm is activated / deactivated by pressing the F3 key ^{4 p. 94}

F4 Key F4. Alarm is activated / deactivated by pressing the F4 key ^{4 p. 94}

d.i. 1 Digital Input 1. Active when digital input 1 is active.

d.i. 2 Digital Input 2. Active when digital input 2 is active.

d.i. 3 Digital Input 3. Active when digital input 3 is active.

d.i. 4 Digital Input 4. Active when digital input 4 is active.

REM. Remote. The alarm is enabled by the word 1245

176 R3P. Alarm 3 Process (only on ATR444-2xABC-X)

Select the size related to alarm 3.

R.i.N.1 Value read on input AI1. (**Default**)

R.i.N.2 Value read on input AI2.

MERn Arithmetic average of the value read on inputs AI1 and AI2 $[(AI1+AI2)/2]$.

d.FF. Difference of the values read on inputs AI1 and AI2 $(AI1-AI2)$.

Rb.d.F. Module of the difference of the values read on inputs AI1 and AI2 $(|AI1-AI2|)$.

Sum Sum of values read on inputs AI1 and AI2 $(AI1+AI2)$.

H.GH. Greater value between AI1 and AI2

LoWER Lower value between AI1 and AI2

REduN. The value read on AI1 or value read on AI2 if AI1 is in error (E-05)

177 R3r.c. Alarm 3 Reference Command (only on ATR444-2xABC-X)

Select alarm 3 reference command

cMd. 1 Alarm referred to command 1. (**Default**)

cMd. 2 Alarm referred to command 2.

178 *R35.o.* Alarm 3 State Output

Alarm 3 output contact and intervention type.

N.o. 5t. (N.O. Start) Normally open, active at start **(Default)**

N.c. 5t. (N.C. Start) Normally closed, active at start

N.o. tH. (N.O. Threshold) Normally open, active on reaching alarm ^{2 p. 94}

N.c. tH. (N.C. Threshold) Normally closed, active on reaching alarm ^{2 p. 94}

N.o. tH.v. (N.O. Threshold Variation) disabled after changing control setpoint ^{3 p. 94}

N.c. tH.v. (N.C. Threshold Variation) disabled after changing control setpoint ^{3 p. 94}

179 *rES.* Reserved

Reserved parameter

180 *R3HY.* Alarm 3 Hysteresis

Alarm 3 hysteresis.

-9999..+9999 [digit^{1 p. 94}] (degrees.tenths for temperature sensors). **Default** 0.5.

181 *R3LL.* Alarm 3 Lower Limit

Lower limit selectable for the alarm 3 setpoint.

-9999..+30000 [digit^{1 p. 94}] (degrees for temperature sensors). **Default** 0.

182 *R3UL.* Alarm 3 Upper Limit

Upper limit selectable for the alarm 3 setpoint.

-9999..+30000 [digit^{1 p. 94}] (degrees for temperature sensors). **Default** 1750.

183 *R3rE.* Alarm 3 Reset

Alarm 3 contact reset type (always automatic if *RL.3.F. = c. R0**).

R. RES. Automatic reset **(Default)**

M. RES. Manual reset (manual reset by keyboard or by digital input)

M.RES.5. Stored manual reset (keeps the output status also after a power failure)

R. RES.t. Automatic reset with timed activation. The alarm remains active for the time set on the parameter 187 *R.3.dE.*, even if the conditions generating it are missing. To be able to act again, the alarm conditions must disappear.

184 *R3SE.* Alarm 3 State Error

Alarm 3 output status in case of error

If the alarm output is relay

oPEN Contact or open valve. **Default**

cLoSE Contact or closed valve.

If the alarm output is digital (SSR):

oFF Digital output OFF. **Default**

oN Digital output ON.

185 *R3SS.* Alarm 3 State Stop

Alarm 3 output status with controller in STOP

If the alarm output is relay

RctV.R. Alarm active. **Default**

oPEN Contact or open valve

cLoSE Contact or closed valve

If the alarm output is digital (SSR):

RctV.R. Alarm active. **Default**

oFF Digital output OFF

oN Digital output ON

186 *R3Ld.* Alarm 3 Led

Defines the status of the led **A3** in correspondence of the relevant output.

- a.c.* ON with open contact, DO switched off or AO deactivated.
- c.c.* ON with closed contact, DO switched on or AO activated. **(Default)**

187 *R3dE.* Alarm 3 Delay

Alarm 3 Delay.

-60:00..60:00 mm:ss (hh:mm if *R3.F. = c. R3dE*). **Default:** 00:00.

Negative value: delay when exit alarm status.

Positive value: delay when enter alarm status

188 *R3SP.* Alarm 3 Setpoint Protection

Allows or not to change the alarm 3 setpoint.

FPRE Editable by the user **(Default)**

Lock Protected

Hide Protected and not visualized

189 *R3LB.* Alarm 3 Label

Selects the message displayed in case of alarm 3 intervention.

d3Rb. Disabled. **(Default)**

Lb. 01 Message 1 (see table paragraph [15.1](#))

...

Lb. 20 Message 20 (see table paragraph [15.1](#))

uSER.L. Custom message (modifiable by the user through the App or via modbus)

190÷194 Reserved Parameters - Group D3

Reserved parameters - Group D3

GROUP D4 - AL 4 - Alarm 4

195 AL4.F. Alarm 4 Function

Alarm 4 selection.

d.5Rb. Disabled (**Default**)

Rb.u.P.R. Absolute Upper Activation. Absolute referred to the process, active over

Rb.Lo.R. Absolute Lower Activation. Absolute referred to the process, active under

bRNd Band alarm (command setpoint ± alarm setpoint)

R.bRNd Asymmetric band alarm (command setpoint + alarm setpoint 4 H and command setpoint - alarm setpoint 4 L)

u.P.dEV. Upper Deviation. Upper Deviation alarm

Lo.dEV. Lower Deviation. Lower Deviation alarm

Rb.c.u.R. Absolute Command Upper Activation. Absolute alarm referred to the command setpoint, active over

Rb.c.L.R. Absolute Command Lower Activation. Absolute alarm referred to the command setpoint, active under

RuN Status alarm (active in RUN/START)

cool Cold actuator auxiliary (Cold action in double loop)

c. Ru% Auxiliary for job distribution on the command output. It cyclically replaces the command output for the time set on the parameter 207 *R.4.dE.* If *R.4.dE.* = 0, it is activated parallel to the command output. It does not work in case of valve control and can only be activated on an alarm if *R.4.dE.* is different from 0.

SEEP.R. Step Auxiliary. Auxiliary output related to the step (ON/OFF at each step).

PPb.ER. Probe error. Alarm active in case of sensor rupture.

H.b.R. Heater Break Alarm and Overcurrent Alarm

tMR.1 Related to timer 1

tMR.2 Related to timer 2

tMR.1.2 Related to both timers

F1 Key F1. Alarm is activated / deactivated by pressing the F1 key ^{4p.94}

F2 Key F2. Alarm is activated / deactivated by pressing the F2 key ^{4p.94}

F3 Key F3. Alarm is activated / deactivated by pressing the F3 key ^{4p.94}

F4 Key F4. Alarm is activated / deactivated by pressing the F4 key ^{4p.94}

d.i. 1 Digital Input 1. Active when digital input 1 is active.

d.i. 2 Digital Input 2. Active when digital input 2 is active.

d.i. 3 Digital Input 3. Active when digital input 3 is active.

d.i. 4 Digital Input 4. Active when digital input 4 is active.

REM. Remote. The alarm is enabled by the word 1246

196 AL4.P. Alarm 4 Process (only on ATR444-2xABC-X)

Selects the size related to alarm 4.

R.i.N.1 Value read on input AI1. (**Default**)

R.i.N.2 Value read on input AI2.

MERh Arithmetic average of the value read on inputs AI1 and AI2 $[(AI1+AI2)/2]$.

d.FF. Difference of the values read on inputs AI1 and AI2 $(AI1-AI2)$.

Rb.d.F. Module of the difference of the values read on inputs AI1 and AI2 $(|AI1-AI2|)$.

Sum Sum of values read on inputs AI1 and AI2 $(AI1+AI2)$.

H.GH. Greater value between AI1 and AI2

LoWER Lower value between AI1 and AI2

REduN. The value read on AI1 or value read on AI2 if AI1 is in error (E-05)

197 AL4.C. Alarm 4 Reference Command (only on ATR444-2xABC-X)

Select alarm 4 reference command

cMd. 1 Alarm referred to command 1. (**Default**)

cMd. 2 Alarm referred to command 2.

198 *RY5.o.* Alarm 4 State Output

Alarm 4 output contact and intervention type.

N.o. 5t. (N.O. Start) Normally open, active at start **(Default)**

N.c. 5t. (N.C. Start) Normally closed, active at start

N.o. tH. (N.O. Threshold) Normally open, active on reaching alarm ^{2 p.94}

N.c. tH. (N.C. Threshold) Normally closed, active on reaching alarm ^{2 p.94}

N.o. tH.V. (N.O. Threshold Variation) disabled after changing control setpoint ^{3 p.94}

N.c. tH.V. (N.C. Threshold Variation) disabled after changing control setpoint ^{3 p.94}

199 *RY.o.t.* Alarm 4 Output Type

Defines the output type if the alarm 4 is analogue.

0.10 V Output 0...10 V. **Default**

4.20mA Output 4...20 mA

10.0 V Output 10..0 V

20.4mA Output 20..4 mA

200 *RY.HY.* Alarm 4 Hysteresis

Alarm 4 hysteresis.

-9999..+9999 [digit^{1 p.94}] (degrees.tenths for temperature sensors). **Default** 0.5.

201 *RY.LL* Alarm 4 Lower Limit

Lower limit selectable for the alarm 4 setpoint.

-9999..+30000 [digit^{1 p.94}] (degrees for temperature sensors). **Default** 0.

202 *RY.u.L* Alarm 4 Upper Limit

Upper limit selectable for the alarm 4 setpoint.

-9999..+30000 [digit^{1 p.94}] (degrees for temperature sensors). **Default** 1750.

203 *RY.r.E.* Alarm 4 Reset

Alarm 4 contact reset type (always automatic if *RL.Y.F. = c. R.u.x*).

R. RES. Automatic reset **(Default)**

M. RES. Manual reset (manual reset by keyboard or by digital input)

M.RES.5. Stored manual reset (keeps the output status also after a power failure)

R. RES.t. Automatic reset with timed activation. The alarm remains active for the time set on the parameter 207 *R.Y.dE.*, even if the conditions generating it are missing. To be able to act again, the alarm conditions must disappear.

204 *RY5.E.* Alarm 4 State Error

Alarm 4 output status in case of error

If the alarm output is relay

aPEN Contact or open valve. **Default**

cLoSE Contact or closed valve.

If the alarm output is digital (SSR):

aFF Digital output OFF. **Default**

aM Digital output ON.

If the alarm output is 0-10V:

0 V 0 V. **Default**

10 V 10 V.

If the alarm output is 0-20 mA or 4-20 mA:

0 mA 0 mA. **Default**

4 mA 4 mA.

20 mA 20 mA.

21.5mA 21.5 mA.

205 *AL55*. Alarm 4 State Stop

Alarm 4 output status with controller in STOP.

If the alarm output is relay

ALV.R. Alarm active. **Default**

oPEN Contact or open valve

cLoSE Contact or closed valve

If the alarm output is digital (SSR):

ALV.R. Alarm active. **Default**

oFF Digital output OFF

oN Digital output ON

If the alarm output is 0-10V:

ALV.R. Alarm active. **Default**

0 V 0 V.

10 V 10 V.

If the alarm output is 0-20 mA or 4-20 mA:

ALV.R. Alarm active. **Default**

0 mA 0 mA

4 mA 4 mA

20 mA 20 mA

21.5mA 21.5 mA

206 *ALd*. Alarm 4 Led

Defines the status of the led A4 in correspondence of the relevant output.

o.c. ON with open contact, DO switched off or AO deactivated.

c.c. ON with closed contact, DO switched on or AO activated. (**Default**)

207 *ALdE*. Alarm 4 Delay

Alarm 4 Delay.

-60:00..60:00 mm:ss (hh:mm if *RL4.F. = c. R4**). **Default:** 00:00.

Negative value: delay when exit alarm status.

Positive value: delay when enter alarm status

208 *AL5P*. Alarm 4 Setpoint Protection

Allows or not to change the alarm 4 setpoint.

FREE Editable by the user (**Default**)

LoCK Protected

HiDE Protected and not visualized

209 *ALLb*. Alarm 4 Label

Selects the message displayed in case of alarm 4 intervention.

d15Ab. Disabled. (**Default**)

Lb. 01 Message 1 (see table paragraph 15.1)

...

Lb. 20 Message 20 (see table paragraph 15.1)

uSER.L. Custom message (modifiable by the user through the App or via modbus)

210÷214 Reserved Parameters - Group D4

Reserved parameters - Group D4.

GROUP D5 - *AL. 5 - Alarm 5* (not available on ATR444-22ABC)

215 *AL.S.F.* Alarm 5 Function

Alarm 5 selection.

d.5Rb. Disabled (**Default**)

Rb.uP.R. Absolute Upper Activation. Absolute referred to the process, active over

Rb.Lo.R. Absolute Lower Activation. Absolute referred to the process, active under

bRNd Band alarm (command setpoint ± alarm setpoint)

R.bRNd Asymmetric band alarm (command setpoint + alarm setpoint 5 H and command setpoint - alarm setpoint 5 L)

uP.dEV. Upper Deviation. Upper Deviation alarm

Lo.dEV. Lower Deviation. Lower Deviation alarm

Rb.c.u.R. Absolute Command Upper Activation. Absolute alarm referred to the command setpoint, active over

Rb.c.L.R. Absolute Command Lower Activation. Absolute alarm referred to the command setpoint, active under

RuN Status alarm (active in RUN/START)

cool Cold actuator auxiliary (Cold action in double loop)

c. Ru% Auxiliary for job distribution on the command output. It cyclically replaces the command output for the time set on the parameter 227 *R.5.dE..* Se *R.5.dE.* = 0, it is activated parallel to the command output. It does not work in case of valve control and can only be activated on an alarm if *R.5.dE.* is different from 0.

SEEP.R. Step Auxiliary. Auxiliary output related to the step (ON/OFF at each step).

PPb.ER. Probe error. Alarm active in case of sensor rupture.

H.b.R. Heater Break Alarm and Overcurrent Alarm

tMR.1 Related to timer 1

tMR.2 Related to timer 2

tMR.1.2 Related to both timers

F1 Key F1. Alarm is activated / deactivated by pressing the F1 key ^{4 p. 94}

F2 Key F2. Alarm is activated / deactivated by pressing the F2 key ^{4 p. 94}

F3 Key F3. Alarm is activated / deactivated by pressing the F3 key ^{4 p. 94}

F4 Key F4. Alarm is activated / deactivated by pressing the F4 key ^{4 p. 94}

d.i. 1 Digital Input 1. Active when digital input 1 is active.

d.i. 2 Digital Input 2. Active when digital input 2 is active.

d.i. 3 Digital Input 3. Active when digital input 3 is active.

d.i. 4 Digital Input 4. Active when digital input 4 is active.

REM. Remote. The alarm is enabled by the word 1247

216 *AS.P.* Alarm 5 Process (only on ATR444-24ABC-T)

Select the size related to alarm 5.

R.i.N.1 Value read on input AI1. (**Default**)

R.i.N.2 Value read on input AI2.

MERN Arithmetic average of the value read on inputs AI1 and AI2 $[(AI1+AI2)/2]$.

d.FF. Difference of the values read on inputs AI1 and AI2 $(AI1-AI2)$.

Rb.d.F. Module of the difference of the values read on inputs AI1 and AI2 $(|AI1-AI2|)$.

Sum Sum of values read on inputs AI1 and AI2 $(AI1+AI2)$.

H.GH. Greater value between AI1 and AI2

LoWER Lower value between AI1 and AI2

REduM. The value read on AI1 or value read on AI2 if AI1 is in error (E-05)

217 *AS.r.c.* Alarm 5 Reference Command (only on ATR444-24ABC-T)

Select alarm 5 reference command

cMd. 1 Alarm referred to command 1. (**Default**)

cMd. 2 Alarm referred to command 2.

218 *R55.o.* Alarm 5 State Output

Alarm 5 output contact and intervention type.

N.o. 5t. (N.O. Start) Normally open, active at start **(Default)**

N.c. 5t. (N.C. Start) Normally closed, active at start

N.o. tH. (N.O. Threshold) Normally open, active on reaching alarm ^{2 p. 94}

N.c. tH. (N.C. Threshold) Normally closed, active on reaching alarm ^{2 p. 94}

N.o. tH.v. (N.O. Threshold Variation) disabled after changing control setpoint ^{3 p. 94}

N.c. tH.v. (N.C. Threshold Variation) disabled after changing control setpoint ^{3 p. 94}

219 *R5.o.t.* Alarm 5 Output Type

Defines the output type if the alarm 5 is analogue.

0.10 V Output 0...10 V. **Default**

4.20mA Output 4...20 mA.

10.0 V Output 10..0 V

20.4mA Output 20..4 mA

220 *R5.HY.* Alarm 5 Hysteresis

Alarm 5 hysteresis.

-9999..+9999 [digit^{1 p. 94}] (degrees.tenths for temperature sensors). **Default** 0.5.

221 *R5.LL.* Alarm 5 Lower Limit

Lower limit selectable for the alarm 5 setpoint.

-9999..+30000 [digit^{1 p. 94}] (degrees for temperature sensors). **Default** 0.

222 *R5.uL.* Alarm 5 Upper Limit

Upper limit selectable for the alarm 5 setpoint.

-9999..+30000 [digit^{1 p. 94}] (degrees for temperature sensors). **Default** 1750.

223 *R5.rE.* Alarm 5 Reset

Alarm 5 contact reset type (always automatic if *RL.5.F. = c. Ru**).

R. RES. Automatic reset **(Default)**

M. RES. Manual reset (manual reset by keyboard or by digital input)

M.RES.5. Stored manual reset (keeps the output status also after a power failure)

R. RES.t. Automatic reset with timed activation. The alarm remains active for the time set on the parameter 227 *R.5.dE.*, even if the conditions generating it are missing. To be able to act again, the alarm conditions must disappear.

224 *R55.E.* Alarm 5 State Error

Alarm 5 output status in case of error

If the alarm output is relay

aPEN Contact or open valve. **Default**

cLoSE Contact or closed valve.

If the alarm output is digital (SSR):

aFF Digital output OFF. **Default**

aM Digital output ON.

If the alarm output is 0-10V:

0 V 0 V. **Default**

10 V 10 V.

If the alarm output is 0-20 mA or 4-20 mA:

0 mA 0 mA. **Default**

4 mA 4 mA

20 mA 20 mA

21.5mA 21.5 mA

225 *R555*. Alarm 5 State Stop

Alarm 5 output status with controller in STOP.

If the alarm output is relay

RcLv.R. Alarm active. **Default**

oPEN Contact or open valve

cLoSE Contact or closed valve

If the alarm output is digital (SSR):

RcLv.R. Alarm active. **Default**

oFF Digital output OFF

oN Digital output ON

If the alarm output is 0-10V:

RcLv.R. Alarm active. **Default**

0 V 0 V

10 V 10 V

If the alarm output is 0-20 mA or 4-20 mA:

RcLv.R. Alarm active. **Default**

0 mA 0 mA

4 mA 4 mA

20 mA 20 mA

21.5mA 21.5 mA

226 *R5Ld*. Alarm 5 Led

Defines the status of the led A5 in correspondence of the relevant output.

o.c. ON with open contact, DO switched off or AO deactivated.

c.c. ON with closed contact, DO switched on or AO activated. (**Default**)

227 *R5dE*. Alarm 5 Delay

Alarm 5 Delay.

-60:00..60:00 mm:ss (hh:mm if *R5L.S.F.* = *c.Ru**). **Default**: 00:00.

Negative value: delay when exit alarm status.

Positive value: delay when enter alarm status

228 *R55P*. Alarm 5 Setpoint Protection

Allows or not to change the alarm 5 setpoint.

FREE Editable by the user (**Default**)

Lock Protected

Hide Protected and not visualized

229 *R5Lb*. Alarm 5 Label

Select the message displayed in case of alarm 5 intervention.

d5Rb. Disabled. (**Default**)

Lb. 01 Message 1 (see table paragraph 15.1)

...

Lb. 20 Message 20 (see table paragraph 15.1)

u5EP.L. Custom message (modifiable by the user through the App or via modbus)

230÷234 Reserved Parameters - Group D5

Reserved parameters - Group D5.

GROUP D6 - *AL. 5* - Alarm 6 (only on ATR444-14ABC-T, ATR444-15ABC and ATR444-24ABC-T)

235 *AL.5.F.* Alarm 6 Function

Alarm 6 selection.

- d.5Rb.* Disabled (**Default**)
- Rb.u.P.R.* Absolute Upper Activation. Absolute referred to the process, active over
- Rb.l.o.R.* Absolute Lower Activation. Absolute referred to the process, active under
- bRNd* Band alarm (command setpoint ± alarm setpoint)
- R.bRNd* Asymmetric band alarm (command setpoint + alarm setpoint 6 H and command setpoint - alarm setpoint 6 L)
- u.P.dEV.* Upper Deviation. Upper Deviation alarm
- L.o.dEV.* Lower Deviation. Lower Deviation alarm
- Rb.c.u.R.* Absolute Command Upper Activation. Absolute alarm referred to the command setpoint, active over
- Rb.c.l.R.* Absolute Command Lower Activation. Absolute alarm referred to the command setpoint, active under
- RuN* Status alarm (active in RUN/START)
- cool* Cold actuator auxiliary (Cold action in double loop)
- c. Ru%* Auxiliary for job distribution on the command output. It cyclically replaces the command output for the time set on the parameter 247 *R.5.dE.*. Se *R.5.dE.* = 0, it is activated parallel to the command output. It does not work in case of valve control and can only be activated on an alarm if *R.5.dE.* is different from 0.
- SEEP.R.* Step Auxiliary. Auxiliary output related to the step (ON/OFF at each step).
- PPb.EP.* Probe error. Alarm active in case of sensor rupture.
- H.b.R.* Heater Break Alarm and Overcurrent Alarm
- tMR.1* Related to timer 1
- tMR.2* Related to timer 2
- tMR.1.2* Related to both timers
- F1* Key F1. Alarm is activated / deactivated by pressing the F1 key ^{4 p. 94}
- F2* Key F2. Alarm is activated / deactivated by pressing the F2 key ^{4 p. 94}
- F3* Key F3. Alarm is activated / deactivated by pressing the F3 key ^{4 p. 94}
- F4* Key F4. Alarm is activated / deactivated by pressing the F4 key ^{4 p. 94}
- d.i. 1* Digital Input 1. Active when digital input 1 is active.
- d.i. 2* Digital Input 2. Active when digital input 2 is active.
- d.i. 3* Digital Input 3. Active when digital input 3 is active.
- d.i. 4* Digital Input 4. Active when digital input 4 is active.
- REM.* Remote. The alarm is enabled by the word 1248

236 *ABP.r.* Alarm 6 Process (only on ATR444-24ABC-T)

Selects the size related to alarm 6.

- R.i.N.1* Value read on input AI1. (**Default**)
- R.i.N.2* Value read on input AI2.
- MERN* Arithmetic average of the value read on inputs AI1 and AI2 $[(AI1+AI2)/2]$.
- d.FF.* Difference of the values read on inputs AI1 and AI2 $(AI1-AI2)$.
- Rb.d.F.* Module of the difference of the values read on inputs AI1 and AI2 $(|AI1-AI2|)$.
- Sum* Sum of values read on inputs AI1 and AI2 $(AI1+AI2)$.
- H.GH.* Greater value between AI1 and AI2
- LoWER* Lower value between AI1 and AI2
- REduN.* The value read on AI1 or value read on AI2 if AI1 is in error (E-05)

237 *AB.r.c.* Alarm 5 Reference Command (only on ATR444-24ABC-T)

Select alarm 6 reference command

- cMd. 1* Alarm referred to command 1. (**Default**)
- cMd. 2* Alarm referred to command 2.

238 *RES.o.* Alarm 6 State Output

Alarm 6 output contact and intervention type.

N.o. 5t. (N.O. Start) Normally open, active at start (**Default**)

N.c. 5t. (N.C. Start) Normally closed, active at start

N.o. tH. (N.O. Threshold) Normally open, active on reaching alarm ^{2 p. 94}

N.c. tH. (N.C. Threshold) Normally closed, active on reaching alarm ^{2 p. 94}

N.o. tH.v. (N.O. Threshold Variation) disabled after changing control setpoint ^{3 p. 94}

N.c. tH.v. (N.C. Threshold Variation) disabled after changing control setpoint ^{3 p. 94}

239 *RES.o.t.* Alarm 6 Output Type

Defines the output type if the alarm 6 is analogue.

0.10 V Output 0...10 V. **Default**

4.20mA Output 4...20 mA.

10.0 V Output 10..0 V

20.4mA Output 20..4 mA

240 *RES.HY.* Alarm 6 Hysteresis

Alarm 6 hysteresis

-9999..+9999 [digit^{1 p. 94}] (degrees.tenths for temperature sensors). **Default** 0.5.

241 *RES.LL.* Alarm 6 Lower Limit

Lower limit selectable for the alarm 6 setpoint.

-9999..+30000 [digit^{1 p. 94}] (degrees for temperature sensors). **Default** 0.

242 *RES.uL.* Alarm 6 Upper Limit

Upper limit selectable for the alarm 6 setpoint.

-9999..+30000 [digit^{1 p. 94}] (degrees for temperature sensors). **Default** 1750.

243 *RES.rE.* Alarm 6 Reset

Alarm 6 contact reset type (always automatic if *RL.E.F. = c. Ru**).

R. RES. Automatic reset (**Default**)

M. RES. Manual reset (manual reset by keyboard or by digital input)

M.RES.S. Stored manual reset (keeps the output status also after a power failure)

R. RES.t. Automatic reset with timed activation. The alarm remains active for the time set on the parameter 247 *R.E.tE.*, even if the conditions generating it are missing. To be able to act again, the alarm conditions must disappear.

244 *RES.E.* Alarm 6 State Error

Alarm 6 output status in case of error

If the alarm output is digital (SSR):

oFF Digital output OFF. **Default**

oH Digital output ON.

If the alarm output is 0-10V:

0 V 0 V. **Default**

10 V 10 V.

If the alarm output is 0-20 mA or 4-20 mA:

0 mA 0 mA. **Default**

4 mA 4 mA.

20 mA 20 mA.

21.5mA 21.5 mA.

245 *RB55*. Alarm 6 State Stop

Alarm 6 output status with controller in STOP.

If the alarm output is digital (SSR):

RcLV.R. Alarm active. **Default**

aFF Digital output OFF

aM Digital output ON

If the alarm output is 0-10V:

RcLV.R. Alarm active. **Default**

0 V 0 V

10 V 10 V

If the alarm output is 0-20 mA or 4-20 mA:

RcLV.R. Alarm active. **Default**

0 mA 0 mA

4 mA 4 mA

20 mA 20 mA

21.5 mA 21.5 mA

246 *RB6d*. Alarm 6 Led

Defines the status of the led A6 in correspondence of the relevant output.

a.c. ON with open contact, DO switched off or AO deactivated.

c.c. ON with closed contact, DO switched on or AO activated. **(Default)**

247 *RB6dE*. Alarm 6 Delay

Alarm 6 Delay.

-60:00..60:00 mm:ss (hh:mm if *RL.B.F.* = *c.* *RL*). **Default:** 00:00.

Negative value: delay when exit alarm status

Positive value: delay when enter alarm status

248 *RB5P*. Alarm 6 Setpoint Protection

Allows or not to change the alarm 6 setpoint.

FREE Editable by the user **(Default)**

Lock Protected

Hide Protected and not visualized

249 *RB6b*. Alarm 6 Label

Selects the message displayed in case of alarm 6 intervention.

d5RB. Disabled. **(Default)**

Lb. 01 Message 1 (see table paragraph 15.1)

...

Lb. 20 Message 20 (see table paragraph 15.1)

uSER.L. Custom message (modifiable by the user through the App or via modbus)

250÷254 Reserved Parameters - Group D6

Reserved parameters - Group D6.

GROUP D7 - AL. 7 - Alarm 7 (only on ATR444-24ABC-T)

255 AL.7.F. Alarm 7 Function

Alarm 7 selection.

d.5Rb. Disabled (**Default**)

Rb.u.P.R. Absolute Upper Activation. Absolute referred to the process, active over

Rb.Lo.R. Absolute Lower Activation. Absolute referred to the process, active under

bRNd Band alarm (command setpoint ± alarm setpoint)

R.bRNd Asymmetric band alarm (command setpoint + alarm setpoint 7 H and command setpoint - alarm setpoint 7 L)

u.P.dEV. Upper Deviation. Upper Deviation alarm

Lo.dEV. Lower Deviation. Lower Deviation alarm

Rb.c.u.R. Absolute Command Upper Activation. Absolute alarm referred to the command setpoint, active over

Rb.c.L.R. Absolute Command Lower Activation. Absolute alarm referred to the command setpoint, active under

RuN Status alarm (active in RUN/START)

cool Cold actuator auxiliary (Cold action in double loop)

*c. Ru** Auxiliary for job distribution on the command output. It cyclically replaces the command output for the time set on the parameter 267 *R.7.dE.*. Se *R.7.dE.* = 0, it is activated parallel to the command output. It does not work in case of valve control and can only be activated on an alarm if *R.7.dE.* is different from 0.

SEEP.R. Step Auxiliary. Auxiliary output related to the step (ON/OFF at each step).

PPb.ER. Probe error. Alarm active in case of sensor rupture.

H.b.R. Heater Break Alarm and Overcurrent Alarm

tMR.1 Related to timer 1

tMR.2 Related to timer 2

tMR.1.2 Related to both timers

F1 Key F1. Alarm is activated / deactivated by pressing the F1 key ^{4 p. 94}

F2 Key F2. Alarm is activated / deactivated by pressing the F2 key ^{4 p. 94}

F3 Key F3. Alarm is activated / deactivated by pressing the F3 key ^{4 p. 94}

F4 Key F4. Alarm is activated / deactivated by pressing the F4 key ^{4 p. 94}

d.i. 1 Digital Input 1. Active when digital input 1 is active.

d.i. 2 Digital Input 2. Active when digital input 2 is active.

d.i. 3 Digital Input 3. Active when digital input 3 is active.

d.i. 4 Digital Input 4. Active when digital input 4 is active.

REM. Remote. The alarm is enabled by the word 1249

256 AL.7.P. Alarm 7 Process

Selects the size related to alarm 7.

R.i.N.1 Value read on input AI1. (**Default**)

R.i.N.2 Value read on input AI2.

MERn Arithmetic average of the value read on inputs AI1 and AI2 $[(AI1+AI2)/2]$.

d.FF. Difference of the values read on inputs AI1 and AI2 $(AI1-AI2)$.

Rb.d.F. Module of the difference of the values read on inputs AI1 and AI2 $(|AI1-AI2|)$.

Sum Sum of values read on inputs AI1 and AI2 $(AI1+AI2)$.

H.GH. Greater value between AI1 and AI2

LoWER Lower value between AI1 and AI2

REdun. The value read on AI1 or value read on AI2 if AI1 is in error (E-05)

257 AL.7.C. Alarm 7 Reference Command

Selects alarm 7 reference command

cMd. 1 Alarm referred to command 1. (**Default**)

cMd. 2 Alarm referred to command 2.

258 *AL5.O.* Alarm 7 State Output

Alarm 7 output contact and intervention type.

N.O. 5E. (N.O. Start) Normally open, active at start (**Default**)

N.C. 5E. (N.C. Start) Normally closed, active at start

N.O. EH. (N.O. Threshold) Normally open, active on reaching alarm ^{2 p.94}

N.C. EH. (N.C. Threshold) Normally closed, active on reaching alarm ^{2 p.94}

N.O. EH.V. (N.O. Threshold Variation) disabled after changing control setpoint ^{3 p.94}

N.C. EH.V. (N.C. Threshold Variation) disabled after changing control setpoint ^{3 p.94}

259 *AL.O.T.* Alarm 7 Output Type

Defines the output type if the alarm 7 is analogue.

0.10 V Output 0...10 V. **Default**

4.20mA Output 4...20 mA.

10.0 V Output 10..0 V

20.4mA Output 20..4 mA

260 *AL.HY.* Alarm 7 Hysteresis

Alarm 7 hysteresis

-9999..+9999 [digit^{1 p.94}] (degrees.tenths for temperature sensors). **Default** 0.5.

261 *AL.LL.* Alarm 7 Lower Limit

Lower limit selectable for the alarm 7 setpoint.

-9999..+30000 [digit^{1 p.94}] (degrees for temperature sensors). **Default** 0.

262 *AL.U.L.* Alarm 7 Upper Limit

Upper limit selectable for the alarm 7 setpoint.

-9999..+30000 [digit^{1 p.94}] (degrees for temperature sensors). **Default** 1750.

263 *AL.R.E.* Alarm 7 Reset

Alarm 7 contact reset type (always automatic if *AL.7.F. = c. R.u.*).

R. RES. Automatic reset (**Default**)

M. RES. Manual reset (manual reset by keyboard or by digital input)

M.RES.S. Stored manual reset (keeps the output status also after a power failure)

R. RES.L. Automatic reset with timed activation. The alarm remains active for the time set on the parameter 267 *R.7.dE.*, even if the conditions generating it are missing. To be able to act again, the alarm conditions must disappear.

264 *AL5.E.* Alarm 7 State Error

Alarm 7 output status in case of error

If the alarm output is 0-10V:

0 V 0 V. **Default**

10 V 10 V.

If the alarm output is 0-20 mA or 4-20 mA:

0 mA 0 mA. **Default**

4 mA 4 mA

20 mA 20 mA

21.5mA 21.5 mA

265 *AL7.SS.* Alarm 7 State Stop

Alarm 7 output status with controller in STOP.

If the alarm output is 0-10V:

AL7.SS. Alarm active. **Default**

0 V 0 V

10 V 10 V

If the alarm output is 0-20 mA or 4-20 mA:

AL7.SS. Alarm active. **Default**

0 mA 0 mA

4 mA 4 mA

20 mA 20 mA

21.5 mA 21.5 mA

266 *rES.* Reserved

Reserved parameter

267 *AL7.dE.* Alarm 7 Delay

Alarm 7 Delay.

-60:00..60:00 mm:ss (hh:mm if *AL7.F.* = *EN*). **Default:** 00:00.

Negative value: delay when exit alarm status

Positive value: delay when enter alarm status

268 *AL7.S.P.* Alarm 7 Setpoint Protection

Allows or not to change the alarm 7 setpoint.

FREE Editable by the user (**Default**)

LOCK Protected

HIDE Protected and not visualized

269 *AL7.Lb.* Alarm 7 Label

Select the message displayed in case of alarm 7 intervention.

DISABLE Disabled. (**Default**)

Lb. 01 Message 1 (see table paragraph 15.1)

...

Lb. 20 Message 20 (see table paragraph 15.1)

USER.L. Custom message (modifiable by the user through the App or via modbus)

270÷274 Reserved Parameters - Group D7

Reserved parameters - Group D7.

GROUP E1 - d.i. 1 - Digital input 1

275 d.i.1.F. Digital Input 1 Function

Digital input 1 functioning.

d.5Rb. Disabled (**Default**)

2E. 5M. 2 Setpoints Switch

2E. 5M. i. 2 Setpoints Switch Impulsive

3E. 5M. i. 3 Setpoints Switch Impulsive

4E. 5M. i. 4 Setpoints Switch Impulsive

5EE. 1 Controller regulates on **SET1**

5EE. 2 Controller regulates on **SET2**

5EE. 3 Controller regulates on **SET3**

5EE. 4 Controller regulates on **SET4**

5EAPL Start (impulsive)

5EoP Stop (impulsive)

5E. /5E. Start / Stop (impulsive)

RuN Run (controller in START with D.I. active, controller in STOP with D.I. disabled)

xE.RL. External alarm. The controller goes on STOP and the alarms will be disabled. The controller does not return to START automatically; for this operation, the user's intervention is required.

HoLd Lock conversion (stop all conversions and display values)

tUNE Performing manual tune

Ru.MR. i. Automatic / Manual Impulse (if enabled on parameter 53 or 76)

Ru.MR. c. Automatic / Manual Contact (if enabled on parameter 53 or 76)

RcE. tY. Action Type. Cooling regulation if D.I. is active, otherwise heating regulation.

PRGM Programmer. 1 cycle Programmer, with D.I. active (if enabled on parameter 312 *PRGM*), otherwise simple controller.

R. kWh Reset kWh. Resets the energy consumed by the system

R. i. 0 Analogue Input 0. Set AI to zero

M. RES. Manual reset. Manual reset. Reset the outputs if selected as manual reset.

t. 1. RuN Timer 1 run. The timer 1 count with activated D.I.

t. 1. 5.E. Timer 1 Start End. D.I. starts and stops the timer 1 (impulsive)

t. 1. 5EtR. Timer 1 Start. D.I. starts the timer 1 (impulsive)

t. 1. ENd Timer 1 End. D.I. stops the timer 1 (impulsive)

t. 2. RuN Timer 2 run. The timer 2 count with activated D.I.

t. 2. 5.E. Timer 2 Start End. D.I. starts and stops the timer 2 (impulsive)

t. 2. 5EtR. Timer 2 Start. D.I. starts the timer 2 (impulsive)

t. 2. ENd Timer 2 End. D.I. stops the timer 2 (impulsive)

Lo. cFG. Lock configuration and setpoints.

uP. KEY Simulates the functioning of up key.

doMn. K. Simulates the functioning of down key.

Fnc. K. Simulates the functioning of **FNC** key.

5EE. K. Simulates the functioning of **SET** key.

REM. 5. E. Remote setpoint enabling. Enables Remote setpoint with activated D.I. Local setpoint with deactivated D.I. (remote setpoint must be enabled on parameter 62 *rEП.5*.)

276 d.i.1.c. Digital Input 1 Contact

Defines the resting contact of the digital input 1.

N. oPEN Normally open (**Default**)

N. cLoS. Normally closed

277 *d.i.1.P.* **Digital Input 1 Process** (only on ATR444-2xABC-X)

Select the size related to the digital input 1 if parameter 275 *d.i.1.F.* = R.i. 0.

R.i.N.1 Value read on input AI1. (Default)

R.i.N.2 Value read on input AI2.

MERH Arithmetic average of the value read on inputs AI1 and AI2 $[(AI1-AI2)/2]$.

d.i.FF. Difference of the values read on inputs AI1 and AI2 $(AI1-AI2)$.

Rb.d.F. Module of the difference of the values read on inputs AI1 and AI2 $(|AI1-AI2|)$.

SUM Sum of values read on inputs AI1 and AI2 $(AI1+AI2)$.

R.i.N.1.2 The value read on AI1 and AI2

278 *d.i.1.r.* **Digital Input 1 Reference Command** (only on ATR444-2xABC-X)

Defines the reference command for the digital input 1 functions.

cMd. 1 Command 1 (Default)

cMd. 2 Command 2

cMd.1.2 Command 1 and 2

279÷283 **Reserved Parameters - Group E1**

Reserved parameters - Group E1.

GROUP E2 - *d.i.2* - Digital input 2

284 *d.i.2.F.* **Digital Input 2 Function**

Digital input 2 functioning.

d.SRb. Disabled (Default)

2E.SW. 2 Setpoints Switch

2E.SW.i. 2 Setpoints Switch Impulsive

3E.SW.i. 3 Setpoints Switch Impulsive

4E.SW.i. 4 Setpoints Switch Impulsive

5EE.1 Controller regulates on [SET1](#)

5EE.2 Controller regulates on [SET2](#)

5EE.3 Controller regulates on [SET3](#)

5EE.4 Controller regulates on [SET4](#)

5EAPt Start (impulsive)

5EoP Stop (impulsive)

5E./5E. Start / Stop (impulsive)

RUN Run (controller in START with D.I. active, controller in STOP with D.I. disabled)

E:ALAR. External alarm. The controller goes on STOP and the alarms will be disabled. The controller does not return to START automatically: for this operation, the user's intervention is required.

Hold Lock conversion (stop all conversions and display values)

tUNE Performing manual tune

Ru.MR.i. Automatic / Manual Impulse (if enabled on parameter 53 or 76)

Ru.MR.c. Automatic / Manual Contact (if enabled on parameter 53 or 76)

RcE.tS. Action Type. Cooling regulation if D.I. is active, otherwise heating regulation.

PRGM Programmer. 1 cycle Programmer, with D.I. active (if enabled on parameter 312 *PRGM*), otherwise simple controller,

R. kWh Reset kWh. It resets the energy consumed by the system

R.i. 0 Analogue Input 0. Set AI to zero

M. RES. Manual reset. Reset the outputs if selected as manual reset.

t.1.RUN Timer 1 run. The timer 1 count with activated D.I.

t.1.S.E. Timer 1 Start End. D.I. starts and stops the timer 1 (impulsive)

t.1.SEt. Timer 1 Start. D.I. starts the timer 1 (impulsive)

t.1.End Timer 1 End. D.I. stops the timer 1 (impulsive)

t.2.RUN Timer 2 run. The timer 2 count with activated D.I.

t.2.S.E. Timer 2 Start End. D.I. starts and stops the timer 2 (impulsive)

t.2.SEt. Timer 2 Start. D.I. starts the timer 2 (impulsive)

t.2.End Timer 2 End. D.I. stops the timer 2 (impulsive)

Lo.cFG.	Lock configuration and setpoints.
uP.KEY	Simulates the functioning of up key.
dOWN.K.	Simulates the functioning of down key.
FNC. K.	Simulates the functioning of FNC key.
SEt. K.	Simulates the functioning of SEt key.
REM.S.E.	Remote setpoint enabling. Enables Remote setpoint with activated D.I. Local setpoint with deactivated D.I. (remote setpoint must be enabled on parameter 62 rEP.5.)

285 d.i.2.c. Digital Input 2 Contact

Defines the resting contact of the digital input 2.

N.oPEN	Normally open (Default)
N.cLoS.	Normally closed

286 d.i.2P. Digital Input 2 Process (only on ATR444-2xABC-X)

Select the size related to the digital input 2.

R.i.N.1	Value read on input AI1. (Default)
R.i.N.2	Value read on input AI2.
MERit	Arithmetic average of the value read on inputs AI1 and AI2 $[(AI1-AI2)/2]$.
dIFF.	Difference of the values read on inputs AI1 and AI2 $(AI1-AI2)$.
Ab.d.F.	Module of the difference of the values read on inputs AI1 and AI2 $(AI1-AI2)$.
Sum	Sum of values read on inputs AI1 and AI2 $(AI1+AI2)$.
R.i.N.i.2	The value read on AI1 and AI2

287 d.i.2.c. Digital Input 2 Reference Command (only on ATR444-2xABC-X)

Defines the reference command for the digital input 2 functions.

cMd. 1	Command 1 (Default)
cMd. 2	Command 2
cMd.i.2	Command 1 and 2

288÷292 Reserved Parameters - Group E2

Reserved parameters - Group E2.

GROUP E3 - d.i.3 - Digital input 3 (not available on ATR244-14ABC-T)

293 d.i.3.F. Digital Input 3 Function

Digital input 3 functioning.

d.SAb.	Disabled (Default)
2Et. 5M.	2 Setpoints Switch
2Et.5M.i.	2 Setpoints Switch Impulsive
3Et.5M.i.	3 Setpoints Switch Impulsive
4Et.5M.i.	4 Setpoints Switch Impulsive
SEt.1	Controller regulates on SEt1
SEt.2	Controller regulates on SEt2
SEt.3	Controller regulates on SEt3
SEt.4	Controller regulates on SEt4
SEtRPt	Start (impulsive)
SEtOP	Stop (impulsive)
SEt./5Et.	Start / Stop (impulsive)
RuN	Run (controller in START with D.I. active, controller in STOP with D.I. disabled)
Ext.AL.	External alarm.The controller goes on STOP and the alarms will be disabled. The controller does not return to START automatically: for this operation, the user's intervention is required.
HoLd	Lock conversion (stop all conversions and display values)
tUNE	Performing manual tune
Ru.MA.i.	Automatic / Manual Impulse (if enabled on parameter 53 or 76)
Ru.MA.c.	Automatic / Manual Contact (if enabled on parameter 53 or 76)
Rct. tY.	Action Type. Cooling regulation if D.I. is active, otherwise heating regulation.

<i>PRGM</i>	Programmer. 1 cycle Programmer, with D.I. active (if enabled on parameter 312 <i>PrGM</i>), otherwise simple controller
<i>R. kWh</i>	Reset kWh. It resets the energy consumed by the system.
<i>R.i. 0</i>	Analogue Input 0. Set AI to zero
<i>M. RES.</i>	Manual reset. Reset the outputs if selected as manual reset.
<i>E.1. RUN</i>	Timer 1 run. The timer 1 count with activated D.I.
<i>E.1. S.E.</i>	Timer 1 Start End. D.I. starts and stops the timer 1 (impulsive)
<i>E.1. StAR.</i>	Timer 1 Start. D.I. starts the timer 1 (impulsive)
<i>E.1. ENd</i>	Timer 1 End. D.I. stops the timer 1 (impulsive)
<i>E.2. RUN</i>	Timer 2 run. The timer 2 count with activated D.I.
<i>E.2. S.E.</i>	Timer 2 Start End. D.I. starts and stops the timer 2 (impulsive)
<i>E.2. StAR.</i>	Timer 2 Start. D.I. starts the timer 2 (impulsive)
<i>E.2. ENd</i>	Timer 2 End. D.I. stops the timer 2 (impulsive)
<i>Lo. cFG.</i>	Lock configuration and setpoints.
<i>uP. KEY</i>	Simulates the functioning of up key.
<i>dowN. K.</i>	Simulates the functioning of down key.
<i>Fnc. K.</i>	Simulates the functioning of FNC key.
<i>SEt. K.</i>	Simulates the functioning of SET key.
<i>REM.S.E.</i>	Remote setpoint enabling. Enables Remote setpoint with activated D.I. Local setpoint with deactivated D.I. (remote setpoint must be enabled on parameter 62 <i>rEn.S.</i>)

294 *d.i.3.c.* Digital Input 3 Contact

Defines the resting contact of the digital input 3.

<i>N. oPEN</i>	Normally open (Default)
<i>N. cLoS.</i>	Normally closed

295 *d.i.3.P.* Digital Input 3 Process *(only on ATR444-2xABC-X)*

Select the size related to the digital input 3.

<i>R. iN. 1</i>	Value read on input AI1. (Default)
<i>R. iN. 2</i>	Value read on input AI2.
<i>MERh</i>	Arithmetic average of the value read on inputs AI1 and AI2 $[(AI1-AI2)/2]$.
<i>d.i.FF.</i>	Difference of the values read on inputs AI1 and AI2 $(AI1-AI2)$.
<i>Ab. d.i.F.</i>	Module of the difference of the values read on inputs AI1 and AI2 $(AI1-AI2)$.
<i>SuM</i>	Sum of values read on inputs AI1 and AI2 $(AI1+AI2)$.
<i>R. iN. 1. 2</i>	The value read on AI1 and AI2

296 *d.i.3.r.* Digital Input 3 Reference Command *(only on ATR444-2xABC-X)*

Defines the reference command for the digital input 3 functions.

<i>cMd. 1</i>	Command 1 (Default)
<i>cMd. 2</i>	Command 2
<i>cMd. 1. 2</i>	Command 1 and 2

297÷301 Reserved Parameters - Group E3

Reserved parameters - Group E3.

GROUP E4 - d. i. 4 - Digital input 4 (not available on ATR244-14ABC-T)

302 d. i. 4.F. Digital Input 4 Function

Digital input 4 functioning.

d.5Rb. Disabled (**Default**)

2E. 5M. 2 Setpoints Switch

2E. 5M. i. 2 Setpoints Switch Impulsive

3E. 5M. i. 3 Setpoints Switch Impulsive

4E. 5M. i. 4 Setpoints Switch Impulsive

5EE. 1 Controller regulates on **SET1**

5EE. 2 Controller regulates on **SET2**

5EE. 3 Controller regulates on **SET3**

5EE. 4 Controller regulates on **SET4**

5EAPL Start (impulsive)

5EoP Stop (impulsive)

5E. /5E. Start / Stop (impulsive)

RuN Run (controller in START with D.I. active, controller in STOP with D.I. disabled)

xE. RL. External alarm. The controller goes on STOP and the alarms will be disabled. The controller does not return to START automatically; for this operation, the user's intervention is required.

HoLd Lock conversion (stop all conversions and display values)

tUNE Performing manual tune

Ru. MR. i. Automatic / Manual Impulse (if enabled on parameter 53 or 76)

Ru. MR. c. Automatic / Manual Contact (if enabled on parameter 53 or 76)

RcE. tY. Action Type. Cooling regulation if D.I. is active, otherwise heating regulation.

PRGM Programmer. 1 cycle Programmer, with D.I. active (if enabled on parameter 312 P-rGn), otherwise simple controller.

R. kWh Reset kWh. Resets the energy consumed by the system

R. i. 0 Analogue Input 0. Set AI to zero

M. RES. Manual reset. Manual reset. Reset the outputs if selected as manual reset.

t. 1. RuN Timer 1 run. The timer 1 count with activated D.I.

t. 1. 5.E. Timer 1 Start End. D.I. starts and stops the timer 1 (impulsive)

t. 1. 5EtR. Timer 1 Start. D.I. starts the timer 1 (impulsive)

t. 1. ENd Timer 1 End. D.I. stops the timer 1 (impulsive)

t. 2. RuN Timer 2 run. The timer 2 count with activated D.I.

t. 2. 5.E. Timer 2 Start End. D.I. starts and stops the timer 2 (impulsive)

t. 2. 5EtR. Timer 2 Start. D.I. starts the timer 2 (impulsive)

t. 2. ENd Timer 2 End. D.I. stops the timer 2 (impulsive)

Lo. cFG. Lock configuration and setpoints.

uP. KEY Simulates the functioning of up key.

doWn. K. Simulates the functioning of down key.

Fnc. K. Simulates the functioning of **FNC** key.

5EE. K. Simulates the functioning of **SET** key.

REM. 5. E. Remote setpoint enabling. Enables Remote setpoint with activated D.I. Local setpoint with deactivated D.I. (remote setpoint must be enabled on parameter 62 r-Et. 5.)

303 d. i. 4.c. Digital Input 4 Contact

Defines the resting contact of the digital input 4.

N. oPEN Normally open (**Default**)

N. cLoS. Normally closed

304 *d.I.P.* Digital Input 4 Process

Select the size related to the digital input 4.

R.I.N.1 Value read on input AI1. (**Default**)

R.I.N.2 Value read on input AI2.

MERH Arithmetic average of the value read on inputs AI1 and AI2 $[(AI1-AI2)/2]$.

d.FF. Difference of the values read on inputs AI1 and AI2 $(AI1-AI2)$.

Ab.d.F. Module of the difference of the values read on inputs AI1 and AI2 $(|AI1-AI2|)$.

Sum Sum of values read on inputs AI1 and AI2 $(AI1+AI2)$.

R.I.N.1.2 The value read on AI1 and AI2

305 *d.R.* Digital Input 4 Reference Command

Defines the reference command for the digital input 4 functions.

cMd. 1 Command 1 (**Default**)

cMd. 2 Command 2

cMd.1.2 Command 1 and 2

306÷310 Reserved Parameters - Group E4

Reserved parameters - Group E4

GROUP F1 - *SFt.S* - Soft-start and mini cycle

311 *dESt.* Delayed Start

To set the initial waiting time for the delayed start of the setting or cycle, even in case of a blackout. The elapsed time is saved every 10 minutes.

Initial waiting time disabled: the controller starts immediately (**Default**)

00:01-24:00 HH.MM Initial waiting time enabled.

312 *PRG* Programmer

Enables the programmer functioning (1 cycle, 12 steps).

d.SRb. Disabled (**Default**)

ENRb. Enabled (all remote setpoint functions are inhibited)

313 *SS.tY.* Soft-Start Type

Enables and selects the soft-start type

d.SRb. Disabled (**Default**)

GPRd. Gradient

PERc. Percentage (only with pre-programmed cycle disabled)

314 *SS.r.c.* Soft-Start Reference Command (*only on ATR444-2xABC-X*)

Defines the reference command for the Soft-Start and the pre-programmed cycle.

cMd. 1 Command 1 (**Default**)

cMd. 2 Command 2

cMd.1.2 Command 1 and 2

315 *SS.Gr.* Soft-Start Gradient

Rising/falling gradient for soft-start and pre-programmed cycle.

0..20000 Digit/ora (degrees.tenth / hour if temperature). (**Default**: 100.0)

316 *SS.PE.* Soft-Start Percentage

Output percentage during soft-start function.

0..100%. (**Default**: 50%)

317 *SS.tH.* Soft-Start Threshold

Threshold under which the soft-start percentage function is activated, at starting.

-9999..30000 [digit^{1/p.94}] (degrees.tenths for temperature sensors) (**Default**: 1000)

318 *SS.t.t.* **Soft-Start Time**

Max. Softstart duration: if the process will not reach the threshold selected on par. *SS.t.t.* within the selected time, the controller starts to regulate on setpoint.

00:00 Disabled

00:01-24:00 hh:mm (Default: 00:15)

319 *U.t.S.E.* **Waiting Time Step End**

Selects time for step end waiting in hh:mm

00:00 Step end waiting excluded

00:01-24:00 hh:mm (Default: 01:00)

320 *RGSE.* **Max. Gap Step End**

Selects max. gap for step end waiting activation. When the difference between setpoint- process is lower than this parameter, controller switches to the next step also without waiting time programmed into parameter 319 *U.t.S.E.*

0..10000 [digit^{10.94}] (degrees.tenth for temperature sensors) (Default: 5.0°C)

321 *r.i.c.y.* **Recovery Interrupted Cycle**

Enables interrupted cycle recovery function

d.i.SRb. Cycle recovery disabled

Ru.t.o.M. Cycle recovery enabled with automatic gradient (Default)

2...200000 Digit/hour (degrees.tenth / hour if temperature). Select recovery gradient (rising).

322÷325 **Reserved Parameters - Group F1**

Reserved parameters - Group F1

GROUP G1 - *d.i.SP.* - Display and interface**326** *v.FL.t* **Visualization Filter**

d.i.SRb. Disabled

P.t.c.H.F Pitchfork filter (Default)

F.i.o.R.d. First Order

F.i.o.R.P. First Order with Pitchfork

2.SR.M. 2 Samples Mean

... ..n Samples Mean

10.SR.M. 10 Samples Mean

327 *v.i.d.2* **Visualization Display 2**

Select visualization on display 2 (second line).

PRo.d.1 (Process Display 1) Visualises which process the display 1 is visualising (Es. *R.i.N.1*)

u.o.M. (Unit Of Measure) Unit of measure set on the parameter 329 *u.o.M.*

c.1.SP.v Command 1 setpoint (Default)

o.u.PE.1 Percentage of command output 1

A.M.P. 1 Ampere from 1 current transformer

d.S.P.c.1 Command process setpoint deviation 1

V.R.L.c.1 Valve position for command 1

W Power on loads (command 1 + command 2 if present)

W.H kWh cmd 1. Energy transferred to loads (command 1 + command 2 if present)

R.i.N.1 Value read on input AI1.

R.i.N.2 Value read on input AI2.

M.E.A.R.N Arithmetic average of the value read on inputs AI1 and AI2 [(AI1-AI2)/2].

d.i.F.F. Difference of the values read on inputs AI1 and AI2 (AI1-AI2).

Ab.d.i.F. Module of the difference of the values read on inputs AI1 and AI2 (|AI1-AI2|).

S.u.M Sum of values read on inputs AI1 and AI2 (AI1+AI2).

H.i.G.H. Greater value between AI1 and AI2

L.o.W.E.R Lower value between AI1 and AI2

c.2.SP.v Command 2 setpoint

- ou.PE.2 Percentage of command output 2
- RMP. 2 Ampere from current transformer 2
- d.S.P.c.2 Command process setpoint deviation 2
- VRL.c.2 Valve position for command 2
- WM.c.1 Power on control load 1
- WWh.c.1 kWh cmd 1. Energy transferred to command load 1
- WM.c.2 Power on control load 2
- WWh.c.2 kWh cmd 2. Energy transferred to command load 2

328 u.r.d.3 Visualization Display 3

Select visualization on display 3.

- StRLE Status controller. RUN, STOP, **MANUAL**, **REMOTE**, STEP1... STEP8 (**Default**)
- PRo.d.1 (Process Display 1) Visualizza quale processo sta visualizzando il display 1 (Es. R.in.)
- u.o.M. (Unit Of Measure) Unit of measure set on the parameter 329 u.o.n.
- c.1.SPv Command 1 setpoint
- ou.PE.1 Percentage of command output 1
- RMP. 1 Ampere from 1 current transformer
- d.S.P.c.1 Command process setpoint deviation 1
- VRL.c.1 Valve position for command 1
- WM Power on loads (command 1 + command 2 if present)
- WWh kWh cmd 1. Energy transferred to loads (command 1 + command 2 if present)
- R.in.1 Value read on input A11.
- R.in.2 Value read on input A12.
- MERN Arithmetic average of the value read on inputs A11 and A12 $[(A11+A12)/2]$.
- d.FF. Difference of the values read on inputs A11 and A12 $(A11-A12)$.
- Ab.d.F. Module of the difference of the values read on inputs A11 and A12 $(|A11-A12|)$.
- Sum Sum of values read on inputs A11 and A12 $(A11+A12)$.
- HiGH Greater value between A11 and A12
- LoWER Lower value between A11 and A12
- c.2.SPv Command 2 setpoint
- ou.PE.2 Percentage of command output 2
- RMP. 2 Ampere from current transformer 2
- d.S.P.c.2 Command process setpoint deviation 2
- VRL.c.2 Valve position for command 2
- WM.c.1 Power on command load 1
- WWh.c.1 kWh cmd 1. Energy transferred to command load 1
- WM.c.2 Power on command load 2
- WWh.c.2 kWh cmd 2. Energy transferred to command load 2

329 u.o.n Unit Of Measure

Select the unit of measurement to show on the displays 2/3 if enabled in parameters 327 and 328.

°C Default	KPR	°N	M/H	KGP
°F	KPR	N	L/S	KIP
K	MPR	KN	L/M	LbF
V	RtM	G	L/H	oZF
MV	MH2o	KG	RPM	PcS
R	MMHG	Q	PH	PER5.
MR	MM	t	PH	(by App)
bRR	cm	oZ	L	
MbRR	dm	Lb	MM	
PSi	M	M/S	KNM	
PR	MM	M/M	KGF	

330 *uSr.P.* **User Menu**

Enables to modify parameter 315 SS.Gr. "Soft-Start Gradient" from the user menu. To modify the gradient, press **SET**.

dSRb. Disabled (**Default**)

ENRb. Enabled (the gradient can be changed from the user menu)

331 *ScL.t.* **Scrolling Time**

Select the duration for the visualization of the user menu data, before returning to the default page.

3 S 3 seconds

5 S 5 seconds (**Default**)

10 S 10 seconds

30 S 30 seconds

1 M.N 1 minutes

5 M.N 5 minutes

10 M.N 10 minutes

MAN.Sc. Manual scroll

332 *bAr.G.* **Bar Graph**

Set the value indicated by the Bar Graph

dSRb Bar graph off

c.1.SPv Command 1 setpoint

ou.PE.1 Command output percentage 1 (Par. *LL.b.G.* and *UL.b.G.* are ignored) (**Default**)

RMP.1 Ampere from current transformer 1

d.S.P.c.1 Command process setpoint deviation 1

VR.P.c.1 Valve position for command 1 (Par. *LL.b.G.* and *UL.b.G.* are ignored)

W Power on loads (command 1 + command 2 if present)

R.N.1 Value read on AI1 input.

R.N.2 Value read on AI2 input.

MERN Arithmetic average of the values read on inputs AI1 e AI2 $[(AI1+AI2)/2]$.

d.FF. Difference of the values read on the inputs AI1 and AI2 $(AI1-AI2)$.

Rb.d.F. Module of the difference in the values read on the inputs AI1 and AI2 $(|AI1-AI2|)$.

Sum Sum of the values read on the inputs AI1 and AI2 $(AI1+AI2)$.

Hi.GH. Greater value between AI1 and AI2

Lo.WEP Lower value between AI1 and AI2

REduM. The value read on AI1 or value read on AI2 if AI1 is in error (E-05)

c.2.SPv Command 2 setpoint

ou.PE.2 Percentage of command output 2 (Par. *LL.b.G.* and *UL.b.G.* are ignored)

RMP.2 Ampere from current transformer 2

d.S.P.c.2 Command process setpoint deviation 2

VR.P.c.2 Valve position for command 2 (Par. *LL.b.G.* and *UL.b.G.* are ignored)

333 *LL.b.G.* **Lower Limit Bar Graph**

Bar Graph lower limit

-9999..+30000 [digit^{1 p.94}] (degrees for temperature sensors). **Default 0.**

334 *UL.b.G.* **Upper Limit Bar Graph**

Bar Graph upper limit

-9999..+30000 [digit^{1 p.94}] (degrees for temperature sensors). **Default 1000.**

335 *v.out* **Voltage Output**

Select the voltage on the sensors power terminals and of the digital outputs (SSR).

12 V 12 volt (**Default**)

24 V 24 volt

336	nFCL	NFC Lock
	d1SRb.	NFC lock disabled: NFC accessible.
	ENRb.	NFC lock enabled: NFC not accessible.

337÷341 Reserved Parameters - Group G1

Reserved parameters - Group G1

GROUP H1 - FFEY. - Function Keys

342 F1F. F1 Key

F1 key operation mode.

d1SRb.	Disabled (Default)
2E.SW.1.	2 Setpoints Switch Impulsive
3E.SW.1.	3 Setpoints Switch Impulsive
4E.SW.1.	4 Setpoints Switch Impulsive
SEE.1	Controller regulates on SET1
SEE.2	Controller regulates on SET2
SEE.3	Controller regulates on SET3
SEE.4	Controller regulates on SET4
SEARP	Start (impulsive)
SEoP	Stop (impulsive)
SE./SE.	Start / Stop (impulsive)
EMNE	Performing manual tune
AMR.1.	Automatic / Manual Impulse (if enabled on parameter 53 or 76)
R. kWh	Reset kWh. Reset the value of energy consumed by the system.
R. 0	Analogue Input 0. Set AI to zero
M. RES.	Manual reset. Reset the outputs if selected as manual reset.
E.1. SE.	Timer 1 Start End. D.I. starts and stops the timer 1(impulsive)
E.1. SE.R.	Timer 1 Start. D.I. starts the timer 1(impulsive)
E.1. ENd	Timer 1 End. D.I. stops the timer 1(impulsive)
E.2. SE.	Timer 2 Start End. D.I. starts and stops the timer 2(impulsive)
E.2. SE.R.	Timer 2 Start. D.I. starts the timer 2(impulsive)
E.2. ENd	Timer 2 End. D.I. stops the timer 2(impulsive)
REM.S.E.	Local/Remote setpoint switch (remote setpoint must be enabled on par. 62 rEN.5)

343 F1C. F1 Contact

Defines the type of contact to be performed on F1 to activate the related function

FSE.PR.	(Fast Press) Fast pressure (Default)
PR.HLd.	(Press & hold) Long pressure (1s).

344 F1P. F1 Process (only on ATR444-2xABC-X)

Selects the value to be brought to 0 when function R. 0. is selected for F1

R.IN.1	Value read on input AI1. (Default)
R.IN.2	Value read on input AI2
MERN	Arithmetic average of the value read on inputs AI1 and AI2 $[(AI1+AI2)/2]$
d1FF.	Difference of the values read on inputs AI1 and AI2 $(AI1-AI2)$
Rb.d1F.	Module of the difference of the values read on inputs AI1 and AI2 $(AI1-AI2)$
Sum	Sum of values read on inputs AI1 and AI2 $(AI1+AI2)$
R.IN.1.2	The value read on AI1 and AI2

345 F1CC. F1 Reference Command

Defines the reference command for F1 functions

cMd. 1	Command 1 (Default)
cMd. 2	Command 2
cMd. 1.2	Command 1 and 2

346 *rES.* **Reserved**
Reserved parameter

347 *rES.* **Reserved**
Reserved parameter

348 *F2 F.* **F2 Key**

F2 key operation mode.

- d1SRb.* Disabled (**Default**)
- 2E.SM.i.* 2 Setpoints Switch Impulsive
- 3E.SM.i.* 3 Setpoints Switch Impulsive
- 4E.SM.i.* 4 Setpoints Switch Impulsive
- SEE.1* Controller regulates on **SET1**
- SEE.2* Controller regulates on **SET2**
- SEE.3* Controller regulates on **SET3**
- SEE.4* Controller regulates on **SET4**
- SEPRt* Start (impulsive)
- SEoP* Stop (impulsive)
- SE./SE.* Start / Stop (impulsive)
- EMtE* Performing manual tune
- AM.MR.i.* Automatic / Manual Impulse (if enabled on parameter 53 or 76)
- R. kWh* Reset kWh. Reset the value of energy consumed by the system.
- R.i. 0* Analogue Input 0. Set AI to zero
- M. RES.* Manual reset. Reset the outputs if selected as manual reset.
- E.1. SE.* Timer 1 Start End. D.I. starts and stops the timer 1(impulsive)
- E.1. SEr.* Timer 1 Start. D.I. starts the timer 1(impulsive)
- E.1. ENd* Timer 1 End. D.I. stops the timer 1(impulsive)
- E.2. SE.* Timer 2 Start End. D.I. starts and stops the timer 2(impulsive)
- E.2. SEr.* Timer 2 Start. D.I. starts the timer 2(impulsive)
- E.2. ENd* Timer 2 End. D.I. stops the timer 2(impulsive)
- REM.S.E.* Local/Remote setpoint switch (remote setpoint must be enabled on par. 62 *rEN.5*)

349 *F2 c.* **F2 Contact**

Defines the type of contact to be performed on F2 to activate the related function

- FSE.PP.* (Fast Press) Fast pressure (**Default**)
- PP.HLd.* (Press & hold) Long pressure (1s).

350 *F2 P.* **F2 Process** (only on ATR444-2xABC-X)

Selects the value to be brought to 0 when function *R.i. 0* is selected for F2

- R.i.N.1* Value read on input AI1. (**Default**)
- R.i.N.2* Value read on input AI2
- MERN* Arithmetic average of the value read on inputs AI1 and AI2 $[(AI1+AI2)/2]$
- d1FF.* Difference of the values read on inputs AI1 and AI2 $(AI1-AI2)$
- Rb.d1F.* Module of the difference of the values read on inputs AI1 and AI2 $(|AI1-AI2|)$
- Sum* Sum of values read on inputs AI1 and AI2 $(AI1+AI2)$
- R.i.N.1.2* The value read on AI1 and AI2

351 *F2 r.c.* **F2 Reference Command**

Defines the reference command for F2 functions.

- cMd. 1* Command 1 (**Default**)
- cMd. 2* Command 2
- cMd. 1.2* Command 1 and 2

352 *rES.* **Reserved**
Reserved parameter

353 rES. Reserved

Reserved parameter

354 F3 F. F3 Key

F3 key operation mode.

d.5Rb. Disabled (**Default**)*2E.5M.1.* 2 Setpoints Switch Impulsive*3E.5M.1.* 3 Setpoints Switch Impulsive*4E.5M.1.* 4 Setpoints Switch Impulsive*5EE.1* Controller regulates on **SET1***5EE.2* Controller regulates on **SET2***5EE.3* Controller regulates on **SET3***5EE.4* Controller regulates on **SET4***5EAPL* Start (impulsive)*5EoP* Stop (impulsive)*5E./5E.* Start / Stop (impulsive)*EoME* Performing manual tune*Au.MR.1.* Automatic / Manual Impulse (if enabled on parameter 53 or 76)*R. kWh* Reset kWh. Reset the value of energy consumed by the system.*R.1. 0* Analogue Input 0. Set AI to zero*M. RES.* Manual reset. Reset the outputs if selected as manual reset.*E.1. 5.E.* Timer 1 Start End. D.I. starts and stops the timer 1(impulsive)*E.1.5EP.* Timer 1 Start. D.I. starts the timer 1(impulsive)*E.1.EMd* Timer 1 End. D.I. stops the timer 1(impulsive)*E.2. 5.E.* Timer 2 Start End. D.I. starts and stops the timer 2(impulsive)*E.2.5EP.* Timer 2 Start. D.I. starts the timer 2(impulsive)*E.2.EMd* Timer 2 End. D.I. stops the timer 2(impulsive)*REM.5.E.* Local/Remote setpoint switch (remote setpoint must be enabled on par. 62 *rEP.5*)**355 F3 c. F3 Contact**

Defines the type of contact to be performed on F3 to activate the related function.

F5E.PR. (Fast Press) Fast pressure (**Default**)*PR.HLd.* (Press & hold) Long pressure (1s).**356 F3 P. F3 Process (only on ATR444-2xABC-X)**Selects the value to be brought to 0 when function *R.1. 0* is selected for F3.*R.1.N.1* Value read on input AI1. (**Default**)*R.1.N.2* Value read on input AI2*MERN* Arithmetic average of the value read on inputs AI1 and AI2 $[(AI1+AI2)/2]$ *d.FF.* Difference of the values read on inputs AI1 and AI2 $(AI1-AI2)$ *Ab.d.F.* Module of the difference of the values read on inputs AI1 and AI2 $(|AI1-AI2|)$ *Sum* Sum of values read on inputs AI1 and AI2 $(AI1+AI2)$ *R.1.N.1.2* The value read on AI1 and AI2**357 F3 r.c. F3 Reference Command**

Defines the reference command for F3 functions.

cMd. 1 Command 1 (**Default**)*cMd. 2* Command 2*cMd.1.2* Command 1 and 2**358 rES. Reserved**

Reserved parameter

359 rES. Reserved

Reserved parameter

360 F4 F. F4 Key

F4 key operation mode.

d.SRb. Disabled (**Default**)

2E.SM.i. 2 Setpoints Switch Impulsive

3E.SM.i. 3 Setpoints Switch Impulsive

4E.SM.i. 4 Setpoints Switch Impulsive

SEE.1 Controller regulates on **SET1**

SEE.2 Controller regulates on **SET2**

SEE.3 Controller regulates on **SET3**

SEE.4 Controller regulates on **SET4**

SEAPL Start (impulsive)

SEoP Stop (impulsive)

SE./SE. Start / Stop (impulsive)

ENE Performing manual tune

AM.MR.i. Automatic / Manual Impulse (if enabled on parameter 53 or 76)

R. kWh Reset kWh. Reset the value of energy consumed by the system.

R.i. 0 Analogue Input 0. Set AI to zero

M. RES. Manual reset. Reset the outputs if selected as manual reset.

E.1. SE. Timer 1 Start End. D.I. starts and stops the timer 1(impulsive)

E.1.SER. Timer 1 Start. D.I. starts the timer 1(impulsive)

E.1.END. Timer 1 End. D.I. stops the timer 1(impulsive)

E.2. SE. Timer 2 Start End. D.I. starts and stops the timer 2(impulsive)

E.2.SER. Timer 2 Start. D.I. starts the timer 2(impulsive)

E.2.END. Timer 2 End. D.I. stops the timer 2(impulsive)

REM.S.E. Local/Remote setpoint switch (remote setpoint must be enabled on par. 62 rEN.5)

361 F4 c. F4 Contact

Defines the type of contact to be performed on F4 to activate the related function.

FSE.PP. (Fast Press) Fast Pressure (**Default**)

PP.HLD. (Press & hold) Long pressure (1s).

362 F4 P. F4 Process (only on ATR444-2xABC-X)

Selects the value to be brought to 0 when function R.i. 0 is selected for F4

R.i.N.1 Value read on input AI1. (**Default**)

R.i.N.2 Value read on input AI2

MERN Arithmetic average of the value read on inputs AI1 and AI2 $[(AI1+AI2)/2]$

d.FF. Difference of the values read on inputs AI1 and AI2 $(AI1-AI2)$

Ab.d.F. Module of the difference of the values read on inputs AI1 and AI2 $(|AI1-AI2|)$

Sum Sum of values read on inputs AI1 and AI2 $(AI1+AI2)$

R.i.N.1.2 The value read on AI1 and AI2

363 F4 r.c. F4 Reference Command

Defines the reference command for F4 functions.

cMd. 1 Command 1 (**Default**)

cMd. 2 Command 2

cMd.1.2 Command 1 and 2

364 rES. Reserved

Reserved parameter

365 rES. Reserved

Reserved parameter

GROUP I1 - $c\acute{t} 1$ - Current Transformer 1

366 $c\acute{t}.1F.$ Current Transformer 1 Function

Enables the CT1 input and select the net frequency

$d.5Rb.$ Disabled (**Default**)

$50 HZ$ 50 Hz

$60 HZ$ 60 Hz

$R..N.2$ Electricity is the value converted by analogue input 2

367 $c\acute{t}.1v.$ Current Transformer 1 Value

Select the current transformer 1 full-scale

$1..300$ Ampere (**Default: 50**)

368 $H.b.1r.$ Heater Break Alarm 1 Reference Command

Defines the heater break Alarm reference command and the CT1 overcurrent.

$cMd. 1$ Command 1 (**Default**)

$cMd. 2$ Command 2

369 $H.b.1t.$ Heater Break Alarm 1 Threshold

CT1 Heater Break Alarm 1 intervention threshold

0 Alarm disabled. (**Default:**)

$0.1-200.0$ Ampere.

370 $oc.1t.$ Overcurrent 1 Alarm Threshold

CT1 Overcurrent Alarm 1 threshold

0 Alarm disabled. (**Default**)

$0.1-300.0$ Ampere

371 $H.b.1d.$ Heater Break Alarm 1 Delay

CT1 Heater Break Alarm and overcurrent alarm activation delay.

$00:00-60:00$ mm:ss (**Default: 01:00**)

372÷376 Reserved Parameters - Group I1

Reserved parameters - Group I1

GROUP I2 - $c\acute{t} 2$ - Current Transformer 2

377 $c\acute{t}.2F.$ Current Transformer 2 Function

Enables the CT2 input and select the net frequency

$d.5Rb.$ Disabled (**Default**)

$50 HZ$ 50 Hz

$60 HZ$ 60 Hz

$R..N.2$ Electricity is the value converted by analog input 2

378 $c\acute{t}.2v.$ Current Transformer 2 Value

Select the current transformer 2 full-scale

$1..300$ Ampere (**Default: 50**)

379 $H.b.2r.$ Heater Break Alarm 2 Reference Command

Defines the heater break Alarm reference command and the CT2 overcurrent.

$cMd. 1$ Command 1 (**Default**)

$cMd. 2$ Command 2

380 $H.b.2t.$ Heater Break Alarm 2 Threshold

CT2 Overcurrent Alarm 1 threshold

0 Alarm disabled. (**Default**)

$0.1-300.0$ Ampere

381 *oc2t.* Overcurrent 2 Alarm Threshold

CT2 Overcurrent Alarm 1 threshold

0 Alarm disabled. (Default)

0.1-300.0 Ampere

382 *Hb2d.* Heater Break Alarm 2 Delay

CT2 Heater Break Alarm and overcurrent alarm activation delay.

00:00-60:00 mm:ss (Default: 01:00)

383÷387 Reserved Parameters - Group I2

Reserved parameters - Group I2

GROUP J1 - *R.O. 1* - Retransmission 1

388 *rt1.* Retransmission 1

Retransmission for AO1. Parameters 390 and 391 define lower and upper limit of the operating scale.

disAb. Disabled (Default)

c.1.SP1 Command 1 setpoint

ou.PE.1 Percentage of command output 1

d.S.P.c.1 Command process setpoint deviation 1

AMP. 1 Ampere from current transformer 1

AL. 1 Alarm 1 setpoint

AL. 2 Alarm 2 setpoint

rd.bu5 Retransmits the value written on word 1241

R.IN.1 Value read on input AI1

R.IN.2 Value read on input AI2

MEAN Arithmetic average of the value read on inputs AI1 and AI2 $((AI1+AI2)/2)$

d.DF. Difference of the values read on inputs AI1 and AI2 $(AI1-AI2)$

Ab.d.F. Module of the difference of the values read on inputs AI1 and AI2 $(|AI1-AI2|)$

SUM Sum of values read on inputs AI1 and AI2 $(AI1+AI2)$

HIGH. Greater value between AI1 and AI2

LOWER Lower value between AI1 and AI2

REDUN. Value read on AI2 if AI1 is in error (E-05)

c.2.SP1 Command 2 setpoint

ou.PE.2 Percentage of command output 2

d.S.P.c.2 Command process setpoint deviation 2

AMP. 2 Ampere from current transformer 2

389 *rt1.* Retransmission 1 Type

Select the retransmission type for AO1

0.10 V Output 0...10 V.

4.20mA Output 4...20 mA. **Default**

390 *rl.LL.* Retransmission 1 Lower Limit

Retransmission 1 lower limit range (value related to 0 V or 0/4 mA).

-9999.+30000 [digit^{1 p.94}] (degrees for temperature sensors), **Default: 0.**

391 *rl.U.L.* Retransmission 1 Upper Limit

Retransmission 1 upper limit range (value related to 10 V or 20 mA).

-9999.+30000 [digit^{1 p.94}] (degrees for temperature sensors), **Default: 1000.**

392 r.15.E. Retransmission 1 State Error

Determines retransmission 1 value in case of error or anomaly

If the retransmission output is 0-10V:

0 V. **Default**
10 V.

If the retransmission output is 0-20 mA or 4-20 mA:

0 mA. **Default**
4 mA.
20 mA.
21.5 mA.

393 r.155. Retransmission 1 State Stop

Determines retransmission 1 value with controller in STOP.

If the alarm output is 0-10V:

Alarm active
0 V. **Default**
10 V.

If the alarm output is 0-20 mA or 4-20 mA:

Alarm active
0 mA. **Default**
4 mA.
20 mA.
21.5 mA.

394÷398 Reserved Parameters - Group J1

Reserved parameters - Group J1

GROUP J2 - R.0. 2 - Retransmission 2 (only on ATR444-24ABC-T)

399 r.172 Retransmission 2

Retransmission for AO1. Par. 401 and 402 define lower and upper limit of the operating scale.

d.5Rb. Disabled (**Default**)
c.1.SP1 Command 1 setpoint
ou.PE.1 Percentage of command output 1
d.5.P.c.1 Command process setpoint deviation 1
RMP.1 Ampere from current transformer 1
RL.1 Alarm 1 setpoint
RL.2 Alarm 2 setpoint
Md.bs5 Retransmits the value written on word 1241
R.N.1 Value read on input AI1
R.N.2 Value read on input AI2
MEAN Arithmetic average of the value read on inputs AI1 and AI2 $[(AI1+AI2)/2]$
d.FF. Difference of the values read on inputs AI1 and AI2 $(AI1-AI2)$
Ab.d.F. Module of the difference of the values read on inputs AI1 and AI2 $(|AI1-AI2|)$
SUM Sum of values read on inputs AI1 and AI2 $(AI1+AI2)$
HiGH Greater value between AI1 and AI2
LoWER Lower value between AI1 and AI2
PEdM. Value read on AI2 if AI1 is in error (E-05)
c.2.SP1 Command 2 setpoint
ou.PE.2 Percentage of command output 2
d.5.P.c.2 Command process setpoint deviation 2
RMP.2 Ampere from current transformer 2

400 r.24. Retransmission 2 Type

Select the retransmission type for AO2

0...10 V.
4...20 mA. **Default**

401 *r2.LL* Retransmission 2 Lower Limit

Retransmission 2 lower limit range (value related to 0 V or 0/4 mA).
-9999..+30000 [digit^{1 p.94}] (degrees for temperature sensors), **Default: 0**.

402 *r2.U.L* Retransmission 2 Upper Limit

Retransmission 2 upper limit range 2 (value related to 10 V or 20 mA).
-9999..+30000 [digit^{1 p.94}] (degrees for temperature sensors), **Default: 1000**.

403 *r25.E* Retransmission 2 State Error

Determines retransmission 2 value in case of error or anomaly.
If the retransmission output is 0-10V:

0 V 0 V. **Default**

10 V 10 V.

If the retransmission output is 0-20 mA or 4-20 mA:

0 mA 0 mA. **Default**

4 mA 4 mA.

20 mA 20 mA.

21.5 mA 21.5 mA.

404 *r255* Retransmission 2 State Stop

Determines retransmission 2 value with controller in STOP.

If the alarm output is 0-10V:

Alarm active Alarm active

0 V 0 V. **Default**

10 V 10 V.

If the alarm output is 0-20 mA or 4-20 mA:

Alarm active Alarm active

0 mA 0 mA. **Default**

4 mA 4 mA.

20 mA 20 mA.

21.5 mA 21.5 mA.

405÷409 Reserved Parameters - Group J2

Reserved parameters - Group J2

GROUP K1 - *5E7* - Serial (only on ATR444-14ABC-T and ATR444-24ABC-T)

410 *SLAd* Slave Address

Select slave address for serial communication.

1..254. **Default: 247**.

411 *bd.rB* Baud Rate

Select baudrate for serial communication

1.2 k 1200 bit/s

28.8 k 28800 bit/s

2.4 k 2400 bit/s

38.4 k 38400 bit/s

4.8 k 4800 bit/s

57.6 k 57600 bit/s

9.6 k 9600 bit/s

115.2k 115200 bit/s

19.2 k 19200 bit/s (**Default**)

412 *5.P.P* Serial Port Parameters

Select the format for the modbus RTU serial communication.

B-N-1 8 bit, no parity, 1 stop bit (**Default**)

B-E-1 8 bit, even parity, 1 stop bit

B-o-1 8 bit, odd parity, 1 stop bit

B-N-2 8 bit, no parity, 2 stop bit

B-E-2 8 bit, even parity, 2 stop bit

B-o-2 8 bit, odd parity, 2 stop bit

413 *SE.dE.* **Serial Delay**
Select serial delay
0..100 ms. **Default:** 5 ms.

414 *oFF.L.* **Off Line**
Select the off-line time. If there is no serial communication during the selected time, the controller switches-off the command output.
0 Offline disabled (**Default**)
0.1-600.0 tenths of second.

415÷419 **Reserved Parameters - Group K1**
Reserved parameters - Group K1

GROUP L1 - *επρ* - Timer

420 *επρ.1* **Timer 1**
Enabling Timer 1
d.SRb. Disabled (**Default**)
ENRb. Enabled
EN.SεR. Enabled and active at start

421 *ε.β.ε.1* **Time Base Timer 1**
Selects time base for timer 1
MM.SS minutes.seconds (**Default**)
HH.MM hours.minutes

422 *A.επ.1* **Action Timer 1**
Select the type of the action executed by the timer 1 to be related to an alarm..
SεRRε Start. Active during timer counting (**Default**)
ENd End. Active at timer expiry
WARRN. Warning. Active 5" before the timer expiry

423 *επρ.2* **Timer 2**
Enabling Timer 2
d.SRb. Disabled (**Default**)
ENRb. Enabled
EN.SεR. Enabled and active at start

424 *ε.β.ε.2* **Time Base Timer 2**
Selects time base for timer 2
MM.SS minutes.seconds (**Default**)
HH.MM hours.minutes

425 *A.επ.2* **Action Timer 2**
Select the type of the action executed by the timer 2 to be related to an alarm..
SεRRε Start. Active during timer counting (**Default**)
ENd End. Active at timer expiry.
WARRN. Warning. Active 5" before the timer expiry.

426 *επρ.S.* **Timers Sequence**
Select the correlation between the two timers.
SINGL. Singles. Timers work independently (**Default**)
SEQ.εE. Sequential. When timer 1 ends, timer 2 starts.
Loop Loop. When a timer ends, another starts.

427 PAR Maintenance Request

View a maintenance request after elapsing of time given on par. 428 PLT PL .

$dSRb$. Disabled (**Default**)

$ENRb$. Enabled

428 PLT Maintenance Time

Select the time in hours for the maintenance request.

Range 1....30000 (**Default**: 1000).

429÷431 Reserved Parameters - Group L1

Reserved parameters - Group L1

15 Alarm intervention modes

15.a Absolute or threshold alarm active over (par. 135 RL . IF = Ab . uPA)

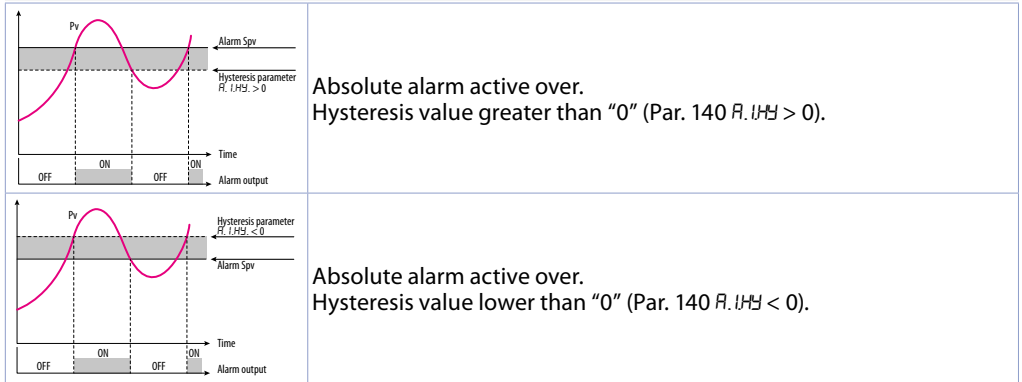

15.b Absolute or threshold alarm active below (par. 135 RL . IF = Ab . uPA)

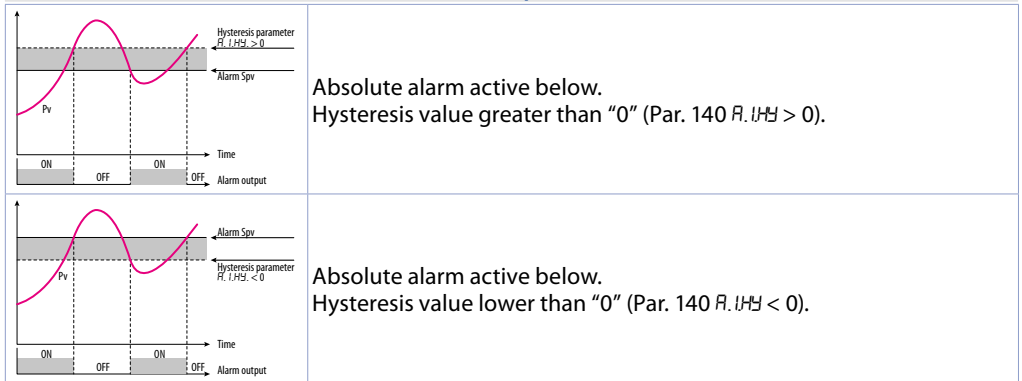

15.c Absolute or threshold alarm referred to command setpoint active over (par. 135 $RL_IF = Ab.c.u.R$)

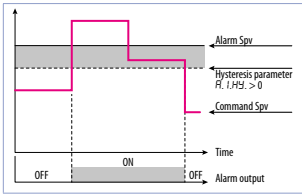

Absolute alarm referred to command setpoint active over.
Hysteresis value greater than "0" (Par. 140 $R.I.H.Y > 0$).

15.d Absolute or threshold alarm referred to command setpoint active below (par. 135 $RL_IF = Ab.c.l.R$)

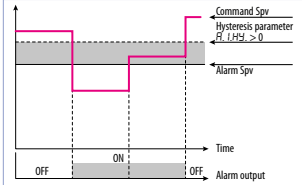

Absolute alarm referred to command setpoint active below.
Hysteresis value greater than "0" (Par. 140 $R.I.H.Y > 0$).

15.e Band alarm (par. 135 $RL_IF = b.R.nd$)

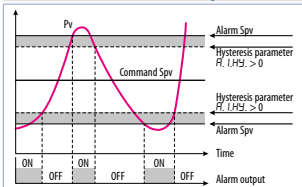

Band alarm hysteresis value greater than "0" (Par. $R.I.H.Y > 0$).

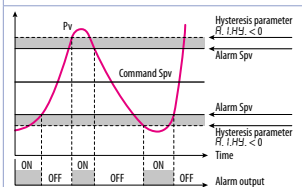

Band alarm hysteresis value lower than "0" (Par. 140 $R.I.H.Y < 0$).

15.f Asymmetric band alarm (par. 135 $RL_IF = R.b.R.nd$)

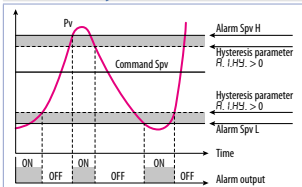

Asymmetric band alarm with hysteresis value greater than "0" (Par. 140 $R.I.H.Y > 0$).

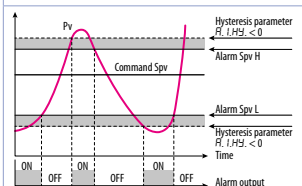

Asymmetric band alarm with hysteresis value lower than "0" (Par. 140 $R.I.H.Y < 0$).

15.g Upper deviation alarm (par. 135 R.L.I.F. = $uP.dE_u$)

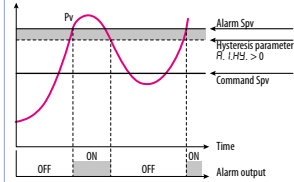

Upper deviation alarm value of alarm setpoint greater than "0" and hysteresis value greater than "0" (Par. 140 R.I.H.Y. > 0).

NB: with hysteresis value less than "0" ($R.I.H.Y. < 0$) the dotted line moves under the alarm setpoint.

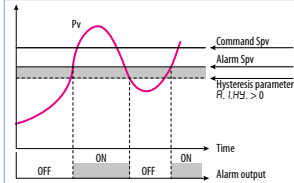

Upper deviation alarm value of alarm setpoint less than "0" and hysteresis value greater than "0" (Par. 140 R.I.H.Y. > 0).

NB: with hysteresis value less than "0" ($R.I.H.Y. < 0$) the dotted line moves under the alarm setpoint.

15.h Lower deviation alarm (par. 135 R.L.I.F. = $Lo.dE_u$)

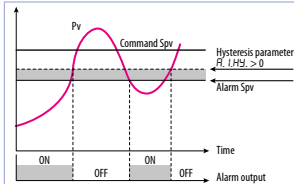

Lower deviation alarm value of alarm setpoint greater than "0" and hysteresis value greater than "0" (Par. 140 R.I.H.Y. > 0).

NB: with hysteresis value less than "0" ($R.I.H.Y. < 0$) the dotted line moves under the alarm setpoint.

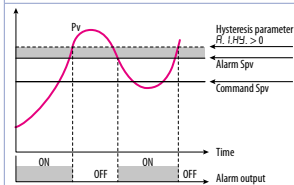

Lower deviation alarm value of alarm setpoint less than "0" and hysteresis value greater than "0" (Par. 140 R.I.H.Y. > 0).

NB: with hysteresis value less than "0" ($R.I.H.Y. < 0$) the dotted line moves under the alarm setpoint.

15.1 Alarms label

By setting a value from 1 to 20 on the parameters 149 R.1.Lb., 169 R.2.Lb., 189 R.3.Lb., 209 R.4.Lb., 229 R.5.Lb., 249 R.6.Lb. and 269 R.7.Lb., the display 3 will show one of the following messages in case of alarm:

Selection	Message displayed in the alarm event
1	alarm 1
2	alarm 2
3	alarm 3
4	alarm 4
5	alarm 5
6	alarm 6
7	open door
8	closed door
9	light on
10	light off

Selection	Message displayed in the alarm event
11	warning
12	waiting
13	high limit
14	low limit
15	external alarm
16	temperature alarm
17	pressure alarm
18	fan command
19	cooling
20	operating

By setting 0, no message will be displayed. While setting 21, the user will have up to 23 characters available to customize his message via the "MyPyxsys" App or via modbus.

16 Table of Anomaly Signals

If installation malfunctions, the controller switches off the regulation output and reports the anomaly noticed. For example, controller will report failure of a connected thermocouple visualizing E-05 (flashing) flashing on display.

For other signals see table below.

	Cause	What to do
E-02 SYSTEM Error	Cold junction temperature sensor failure or environment temperature out of range	Call assistance
E-04 EEPROM Error	Incorrect configuration data. Possible loss of instrument calibration	Verify that configuration parameters are correct.
E-05 Probe 1 Error	Sensor connected to AI1 broken or temperature out of range	Control connection with probes and their integrity.
E-06 Probe 2 Error	Sensor connected to AI2 broken or temperature out of range	Control connection with probes and their integrity.
E-08 SYSTEM Error	Missing calibration	Call assistance
E-10 An. In. 2 disabled	Analogue input 2 disabled but used during configuration.	Enable <i>An.2</i> or disable it during configuration.
E-80 rFid Error	Tag rfid malfunctioning	Call assistance

Notes / Updates

- 1 Display of decimal point depends on setting of parameter *SEn.1* and *d.P.1* or *SEn.2* and *d.P.2*.
- 2 On activation, the output is inhibited if the controller is in alarm mode. Activates only if alarm condition reappears, after that it was restored.
- 3 Changing the control setpoint, the alarm will be disabled. It will stay disabled as long as the parameters that created it are active. It only works with deviation alarms, band alarms and absolute alarms (referring to the control setpoint).
- 4 The alarm remains active for the time set on the parameter *R.x.dE*, if different from 0.

Table of configuration parameters

GROUP A1 - <i>R.in.1</i> - Analogue input 1			
1	<i>SEn.1</i>	Sensor AI1	37
2	<i>d.P.1</i>	Decimal Point 1	37
3	<i>dEGr.</i>	Degree	37
4	<i>LL.i.1</i>	Lower Linear Input AI1	37
5	<i>UL.i.1</i>	Upper Linear Input AI1	37
6	<i>P.wA.1</i>	Potentiometer Value AI1	38
7	<i>l.o.L.1</i>	Linear Input over Limits AI1	38
8	<i>L.c.E.1</i>	Lower Current Error 1	38
9	<i>o.cA.1</i>	Offset Calibration AI1	38
10	<i>G.cA.1</i>	Gain Calibration AI1	38
11	<i>Lt.c.1</i>	Latch-On AI1	38
12	<i>c.FL.1</i>	Conversion Filter AI1	38
13	<i>c.Fr.1</i>	Conversion Frequency AI1	38
14÷18		Reserved Parameters - Group A1	38
GROUP A2 - <i>R.in.2</i> - Analogue input 2 (only on ATR444-2xABC-X)			
19	<i>SEn.2</i>	Sensor AI2	39
20	<i>d.P.2</i>	Decimal Point 2	39
21	<i>rES.</i>	Reserved	39
22	<i>LL.i.2</i>	Lower Linear Input AI2	39
23	<i>UL.i.2</i>	Upper Linear Input AI2	39
24	<i>P.wA.2</i>	Potentiometer Value AI2	39
25	<i>l.o.L.2</i>	Linear Input over Limits AI2	40
26	<i>L.c.E.2</i>	Lower Current Error 2	40
27	<i>o.cA.2</i>	Offset Calibration AI2	40
28	<i>G.cA.2</i>	Gain Calibration AI2	40
29	<i>Lt.c.2</i>	Latch-On AI2	40
30	<i>c.FL.2</i>	Conversion Filter AI2	40
31	<i>c.Fr.2</i>	Conversion Frequency AI2	40
32÷36		Reserved Parameters - Group A2	40
GROUP B1 - <i>cPd.1</i> - Outputs and regulation Process 1			
37	<i>c.ov.1</i>	Command Output 1	41
38	<i>c.Pr.1</i>	Command Process 1 (only on ATR444-2xABC-X)	42
39	<i>rES.</i>	Reserved	42
40	<i>Ac.t.1</i>	Action type 1	42
41	<i>c.HY.1</i>	Command Hysteresis 1	42
42	<i>LL.S.1</i>	Lower Limit Setpoint 1	42
43	<i>UL.S.1</i>	Upper Limit Setpoint 1	42
44	<i>c.rE.1</i>	Command Reset 1	42
45	<i>c.S.E.1</i>	Command State Error 1	43
46	<i>c.S.S.1</i>	Command State Stop 1	43
47	<i>c.Ld.1</i>	Command Led 1	43
48	<i>c.dE.1</i>	Command Delay 1	43
49	<i>c.S.P.1</i>	Command Setpoint Protection 1	43
50	<i>vA.t.1</i>	Valve Time 1	44
51	<i>v.FE.P.</i>	Valve Feedback Potentiometer (only on ATR444-2xABC-X)	44
52	<i>S.v.S.1</i>	State Valve Saturation 1	44
53	<i>R.MA.1</i>	Automatic / Manual 1	44
54	<i>L.P.r.1</i>	Load Power Rating 1	44

55	<i>ini.5</i>	Initial State	44
56÷59		Reserved Parameters - Group B1	44
GROUP B2 - <i>cPd.2</i> - Outputs and regul. Process 2 (only on ATR444-2xABC-X)			
60	<i>c.ov.2</i>	Command Output 2	45
61	<i>c.Pr.2</i>	Command Process 2	45
62	<i>rEN.5</i>	Remote Setpoint	45
63	<i>Ac.t.2</i>	Action type 2	46
64	<i>c.HY.2</i>	Command Hysteresis 2	46
65	<i>LLS.2</i>	Lower Limit Setpoint 2	46
66	<i>uLS.2</i>	Upper Limit Setpoint 2	46
67	<i>c.rE.2</i>	Command Reset 2	46
68	<i>c.S.E.2</i>	Command State Error 2	46
69	<i>c.S.S.2</i>	Command State Stop 2	46
70	<i>c.Ld.2</i>	Command Led 2	47
71	<i>c.dE.2</i>	Command Delay 2	47
72	<i>c.S.P.2</i>	Command Setpoint Protection 2	47
73	<i>vA.t.2</i>	Valve Time 2	47
74	<i>rES.</i>	Reserved	47
75	<i>S.v.S.2</i>	State Valve Saturation 2	47
76	<i>A.MA.2</i>	Automatic / Manual 2	47
77	<i>L.P.r.2</i>	Load Power Rating 2	47
78÷82		Reserved Parameters - Group B2	47
GROUP C1 - <i>rEG.1</i> - Autotuning and PID 1			
83	<i>tun.1</i>	Tune 1	48
84	<i>S.d.t.1</i>	Setpoint Deviation Tune 1	48
85	<i>P.b. 1</i>	Proportional Band 1	48
86	<i>i.t. 1</i>	Integral Time 1	48
87	<i>d.t. 1</i>	Derivative Time 1	48
88	<i>d.b. 1</i>	Dead Band 1	48
89	<i>P.b.c.1</i>	Proportional Band Centered 1	48
90	<i>o.o.S.1</i>	Off Over Setpoint 1	48
91	<i>o.d.t.1</i>	Off Deviation Threshold 1	48
92	<i>c.t. 1</i>	Cycle Time 1	48
93	<i>co.F.1</i>	Cooling Fluid 1	49
94	<i>P.b.M.1</i>	Proportional Band Multiplier 1	49
95	<i>o.d.b.1</i>	Overlap / Dead Band 1	49
96	<i>c.c.t.1</i>	Cooling Cycle Time 1	49
97	<i>LLP.1</i>	Lower Limit Output Percentage 1	49
98	<i>uLP.1</i>	Upper Limit Output Percentage 1	49
99	<i>M.G.t.1</i>	Max Gap Tune 1	49
100	<i>Mn.P.1</i>	Minimum Proportional Band 1	49
101	<i>MA.P.1</i>	Maximum Proportional Band 1	49
102	<i>Mn.i.1</i>	Minimum Integral Time 1	49
103	<i>d.cA.1</i>	Derivative Calculation 1	50
104	<i>o.c.L.1</i>	Overshoot Control Level 1	50
105÷108		Reserved Parameters - Group C1	50
GROUP C2 - <i>rEG.2</i> - Autotuning and PID 2 (only on ATR444-2xABC-X)			
109	<i>tun.2</i>	Tune 2	50
110	<i>S.d.t.2</i>	Setpoint Deviation Tune 2	50
111	<i>P.b. 2</i>	Proportional Band 2	50

112	<i>i.t. 2</i>	Integral Time 2	50
113	<i>d.t. 2</i>	Derivative Time 2	50
114	<i>d.b. 2</i>	Dead Band 2	50
115	<i>P.b.c.2</i>	Proportional Band Centered 2	51
116	<i>o.o.S.2</i>	Off Over Setpoint 2	51
117	<i>o.d.t.2</i>	Off Deviation Threshold 2	51
118	<i>c.t. 2</i>	Cycle Time 2	51
119	<i>co.f.2</i>	Cooling Fluid 2	51
120	<i>P.b.Π.2</i>	Proportional Band Multiplier 2	51
121	<i>o.d.b.2</i>	Overlap / Dead Band 2	51
122	<i>c.c.t.2</i>	Cooling Cycle Time 2	51
123	<i>L.L.P.2</i>	Lower Limit Output Percentage 2	51
124	<i>u.L.P.2</i>	Upper Limit Output Percentage 2	51
125	<i>Π.G.t.2</i>	Max Gap Tune 2	51
126	<i>Πn.P.2</i>	Minimum Proportional Band 2	52
127	<i>ΠΠ.P.2</i>	Maximum Proportional Band 2	52
128	<i>Πn.i.2</i>	Minimum Integral Time 2	52
129	<i>d.c.Π.2</i>	Derivative Calculation 2	52
130	<i>o.c.L.2</i>	Overshoot Control Level 2	52
131÷134		Reserved Parameters - Group C2	52

GROUP D1 - *AL. 1* - Alarm 1

135	<i>AL.1.F.</i>	Alarm 1 Function	53
136	<i>AL.1.P.r.</i>	Alarm 1 Process (only on ATR444-2xABC-X)	53
137	<i>AL.1.r.c.</i>	Alarm 1 Reference Command (only on ATR444-2xABC-X)	53
138	<i>AL.1.S.o.</i>	Alarm 1 State Output	54
139	<i>r.E.S.</i>	Reserved	54
140	<i>AL.1.H.Y.</i>	Alarm 1 Hysteresis	54
141	<i>AL.1.L.L.</i>	Alarm 1 Lower Limit	54
142	<i>AL.1.u.L.</i>	Alarm 1 Upper Limit	54
143	<i>AL.1.r.E.</i>	Alarm 1 Reset	54
144	<i>AL.1.S.E.</i>	Alarm 1 State Error	54
145	<i>AL.1.S.S.</i>	Alarm 1 State Stop	54
146	<i>AL.1.L.d.</i>	Alarm 1 Led	54
147	<i>AL.1.d.E.</i>	Alarm 1 Delay	54
148	<i>AL.1.S.P.</i>	Alarm 1 Setpoint Protection	55
149	<i>AL.1.L.b.</i>	Alarm 1 Label	55
150÷154		Reserved Parameters - Group D1	55

GROUP D2 - *AL. 2* - Alarm 2

155	<i>AL.2.F.</i>	Alarm 2 Function	55
156	<i>AL.2.P.r.</i>	Alarm 2 Process (only on ATR444-2xABC-X)	56
157	<i>AL.2.r.c.</i>	Alarm 2 Reference Command (only on ATR444-2xABC-X)	56
158	<i>AL.2.S.o.</i>	Alarm 2 State Output	56
159	<i>r.E.S.</i>	Reserved	56
160	<i>AL.2.H.Y.</i>	Alarm 2 Hysteresis	56
161	<i>AL.2.L.L.</i>	Alarm 2 Lower Limit	56
162	<i>AL.2.u.L.</i>	Alarm 2 Upper Limit	56
163	<i>AL.2.r.E.</i>	Alarm 2 Reset	56
164	<i>AL.2.S.E.</i>	Alarm 2 State Error	57
165	<i>AL.2.S.S.</i>	Alarm 2 State Stop	57
166	<i>AL.2.L.d.</i>	Alarm 2 Led	57
167	<i>AL.2.d.E.</i>	Alarm 2 Delay	57

168	<i>R25.P.</i>	Alarm 2 Setpoint Protection	57
169	<i>R2.Lb.</i>	Alarm 2 Label	57
170÷174		Reserved Parameters - Group D2	57
GROUP D3 - <i>AL. 3</i> - Alarm 3			
175	<i>AL3.F.</i>	Alarm 3 Function	58
176	<i>AL3.Pr.</i>	Alarm 3 Process (only on ATR444-2xABC-X)	58
177	<i>AL3.r.c.</i>	Alarm 3 Reference Command (only on ATR444-2xABC-X)	58
178	<i>AL3.o.</i>	Alarm 3 State Output	59
179	<i>rES.</i>	Reserved	59
180	<i>AL3.HY.</i>	Alarm 3 Hysteresis	59
181	<i>AL3.LL</i>	Alarm 3 Lower Limit	59
182	<i>AL3.u.L</i>	Alarm 3 Upper Limit	59
183	<i>AL3.rE.</i>	Alarm 3 Reset	59
184	<i>AL3.S.E.</i>	Alarm 3 State Error	59
185	<i>AL3.S.S.</i>	Alarm 3 State Stop	59
186	<i>AL3.Ld.</i>	Alarm 3 Led	60
187	<i>AL3.dE.</i>	Alarm 3 Delay	60
188	<i>AL3.S.P.</i>	Alarm 3 Setpoint Protection	60
189	<i>AL3.Lb.</i>	Alarm 3 Label	60
190÷194		Reserved Parameters - Group D3	60
GROUP D4 - <i>AL. 4</i> - Alarm 4			
195	<i>AL4.F.</i>	Alarm 4 Function	61
196	<i>AL4.Pr.</i>	Alarm 4 Process (only on ATR444-2xABC-X)	61
197	<i>AL4.r.c.</i>	Alarm 4 Reference Command (only on ATR444-2xABC-X)	61
198	<i>AL4.o.</i>	Alarm 4 State Output	62
199	<i>AL4.o.t.</i>	Alarm 4 Output Type	62
200	<i>AL4.HY.</i>	Alarm 4 Hysteresis	62
201	<i>AL4.LL</i>	Alarm 4 Lower Limit	62
202	<i>AL4.u.L</i>	Alarm 4 Upper Limit	62
203	<i>AL4.rE.</i>	Alarm 4 Reset	62
204	<i>AL4.S.E.</i>	Alarm 4 State Error	62
205	<i>AL4.S.S.</i>	Alarm 4 State Stop	63
206	<i>AL4.Ld.</i>	Alarm 4 Led	63
207	<i>AL4.dE.</i>	Alarm 4 Delay	63
208	<i>AL4.S.P.</i>	Alarm 4 Setpoint Protection	63
209	<i>AL4.Lb.</i>	Alarm 4 Label	63
210÷214		Reserved Parameters - Group D4	63
GROUP D5 - <i>AL. 5</i> - Alarm 5 (not available on ATR444-22ABC)			
215	<i>AL5.F.</i>	Alarm 5 Function	64
216	<i>AL5.Pr.</i>	Alarm 5 Process (only on ATR444-24ABC-T)	64
217	<i>AL5.r.c.</i>	Alarm 5 Reference Command (only on ATR444-24ABC-T)	64
218	<i>AL5.o.</i>	Alarm 5 State Output	65
219	<i>AL5.o.t.</i>	Alarm 5 Output Type	65
220	<i>AL5.HY.</i>	Alarm 5 Hysteresis	65
221	<i>AL5.LL</i>	Alarm 5 Lower Limit	65
222	<i>AL5.u.L</i>	Alarm 5 Upper Limit	65
223	<i>AL5.rE.</i>	Alarm 5 Reset	65
224	<i>AL5.S.E.</i>	Alarm 5 State Error	65
225	<i>AL5.S.S.</i>	Alarm 5 State Stop	66
226	<i>AL5.Ld.</i>	Alarm 5 Led	66

227	<i>AL5.dE.</i>	Alarm 5 Delay	66
228	<i>AL5.S.P.</i>	Alarm 5 Setpoint Protection	66
229	<i>AL5.Lb.</i>	Alarm 5 Label	66
230÷234		Reserved Parameters - Group D5	66

GROUP D6 - AL 6 - Alarm 6 (only on ATR444-14ABC-T, ATR444-15ABC and ATR444-24ABC-T)

235	<i>AL6.F.</i>	Alarm 6 Function	67
236	<i>AL6.Pr.</i>	Alarm 6 Process (only on ATR444-24ABC-T)	67
237	<i>AL6.r.c.</i>	Alarm 6 Reference Command (only on ATR444-24ABC-T)	67
238	<i>AL6.S.o.</i>	Alarm 6 State Output	68
239	<i>AL6.o.t.</i>	Alarm 6 Output Type	68
240	<i>AL6.HY.</i>	Alarm 6 Hysteresis	68
241	<i>AL6.L.L.</i>	Alarm 6 Lower Limit	68
242	<i>AL6.U.L.</i>	Alarm 6 Upper Limit	68
243	<i>AL6.rE.</i>	Alarm 6 Reset	68
244	<i>AL6.S.E.</i>	Alarm 6 State Error	68
245	<i>AL6.S.S.</i>	Alarm 6 State Stop	69
246	<i>AL6.Ld.</i>	Alarm 6 Led	69
247	<i>AL6.dE.</i>	Alarm 6 Delay	69
248	<i>AL6.S.P.</i>	Alarm 6 Setpoint Protection	69
249	<i>AL6.Lb.</i>	Alarm 6 Label	69
250÷254		Reserved Parameters - Group D6	69

GROUP D7 - AL 7 - Alarm 7 (only on ATR444-24ABC-T)

255	<i>AL7.F.</i>	Alarm 7 Function	70
256	<i>AL7.Pr.</i>	Alarm 7 Process	70
257	<i>AL7.r.c.</i>	Alarm 7 Reference Command	70
258	<i>AL7.S.o.</i>	Alarm 7 State Output	71
259	<i>AL7.o.t.</i>	Alarm 7 Output Type	71
260	<i>AL7.HY.</i>	Alarm 7 Hysteresis	71
261	<i>AL7.L.L.</i>	Alarm 7 Lower Limit	71
262	<i>AL7.U.L.</i>	Alarm 7 Upper Limit	71
263	<i>AL7.rE.</i>	Alarm 7 Reset	71
264	<i>AL7.S.E.</i>	Alarm 7 State Error	71
265	<i>AL7.S.S.</i>	Alarm 7 State Stop	72
266	<i>rES.</i>	Reserved	72
267	<i>AL7.dE.</i>	Alarm 7 Delay	72
268	<i>AL7.S.P.</i>	Alarm 7 Setpoint Protection	72
269	<i>AL7.Lb.</i>	Alarm 7 Label	72
270÷274		Reserved Parameters - Group D7	72

GROUP E1 - d.i. 1 - Digital input 1

275	<i>d.i.1.F.</i>	Digital Input 1 Function	73
276	<i>d.i.1.c.</i>	Digital Input 1 Contact	73
277	<i>d.i.1.P.</i>	Digital Input 1 Process (only on ATR444-2xABC-X)	74
278	<i>d.i.1.r.</i>	Digital Input 1 Reference Command (only on ATR444-2xABC-X)	74
279÷283		Reserved Parameters - Group E1	74

GROUP E2 - d.i. 2 - Digital input 2

284	<i>d.i.2.F.</i>	Digital Input 2 Function	74
285	<i>d.i.2.c.</i>	Digital Input 2 Contact	75
286	<i>d.i.2.P.</i>	Digital Input 2 Process (only on ATR444-2xABC-X)	75
287	<i>d.i.2.r.</i>	Digital Input 2 Reference Command (only on ATR444-2xABC-X)	75
288÷292		Reserved Parameters - Group E2	75

GROUP E3 - <i>d.i.3</i> - Digital input 3 (not available on ATR244-14ABC-T)			
293	<i>d.i.3.F.</i>	Digital Input 3 Function	75
294	<i>d.i.3.c.</i>	Digital Input 3 Contact	76
295	<i>d.i.3.P.</i>	Digital Input 3 Process (only on ATR444-2xABC-X)	76
296	<i>d.i.3.r.</i>	Digital Input 3 Reference Command (only on ATR444-2xABC-X)	76
297÷301		Reserved Parameters - Group E3	76
GROUP E4 - <i>d.i.4</i> - Digital input 4 (not available on ATR244-14ABC-T)			
302	<i>d.i.4.F.</i>	Digital Input 4 Function	77
303	<i>d.i.4.c.</i>	Digital Input 4 Contact	77
304	<i>d.i.4.P.</i>	Digital Input 4 Process	78
305	<i>d.i.4.r.</i>	Digital Input 4 Reference Command	78
306÷310		Reserved Parameters - Group E4	78
GROUP F1 - <i>S.Ft.5</i> - Soft-start and mini cycle			
311	<i>dE.St.</i>	Delayed Start	78
312	<i>P.GN</i>	Programmer	78
313	<i>SS.ty.</i>	Soft-Start Type	78
314	<i>SS.r.c.</i>	Soft-Start Reference Command (only on ATR444-2xABC-X)	78
315	<i>SS.Gr.</i>	Soft-Start Gradient	78
316	<i>SS.PE.</i>	Soft-Start Percentage	78
317	<i>SS.tH.</i>	Soft-Start Threshold	78
318	<i>SS.t.t.</i>	Soft-Start Time	79
319	<i>U.t.S.E.</i>	Waiting Time Step End	79
320	<i>M.G.S.E.</i>	Max. Gap Step End	79
321	<i>r.i.c.Y.</i>	Recovery Interrupted Cycle	79
322÷325		Reserved Parameters - Group F1	79
GROUP G1 - <i>d.SP.</i> - Display and interface			
326	<i>v.FLt</i>	Visualization Filter	79
327	<i>v.i.d.2</i>	Visualization Display 2	79
328	<i>v.i.d.3</i>	Visualization Display 3	80
329	<i>u.o.M</i>	Unit Of Measure	80
330	<i>uSr.M.</i>	User Menu	81
331	<i>ScLt.t.</i>	Scrolling Time	81
332	<i>bAr.G.</i>	Bar Graph	81
333	<i>LL.b.G.</i>	Lower Limit Bar Graph	81
334	<i>UL.b.G.</i>	Upper Limit Bar Graph	81
335	<i>v.out</i>	Voltage Output	81
336	<i>nFc.L.</i>	NFC Lock	82
337÷341		Reserved Parameters - Group G1	82
GROUP H1 - <i>F.Ft.Y.</i> - Function Keys			
342	<i>F1.F.</i>	F1 Key	82
343	<i>F1.c.</i>	F1 Contact	82
344	<i>F1.P.</i>	F1 Process (only on ATR444-2xABC-X)	82
345	<i>F1.r.c.</i>	F1 Reference Command	82
346	<i>rES.</i>	Reserved	83
347	<i>rES.</i>	Reserved	83
348	<i>F2.F.</i>	F2 Key	83
349	<i>F2.c.</i>	F2 Contact	83
350	<i>F2.P.</i>	F2 Process (only on ATR444-2xABC-X)	83
351	<i>F2.r.c.</i>	F2 Reference Command	83
352	<i>rES.</i>	Reserved	83

353	<i>rES.</i>	Reserved	84
354	<i>F3 k.</i>	F3 Key	84
355	<i>F3 c.</i>	F3 Contact	84
356	<i>F3 P.</i>	F3 Process (only on ATR444-2xABC-X)	84
357	<i>F3 r.c.</i>	F3 Reference Command	84
358	<i>rES.</i>	Reserved	84
359	<i>rES.</i>	Reserved	84
360	<i>F4 k.</i>	F4 Key	85
361	<i>F4 c.</i>	F4 Contact	85
362	<i>F4 P.</i>	F4 Process (only on ATR444-2xABC-X)	85
363	<i>F4 r.c.</i>	F4 Reference Command	85
364	<i>rES.</i>	Reserved	85
365	<i>rES.</i>	Reserved	85

GROUP I1 - *ct 1* - Current Transformer 1

366	<i>ct.1F.</i>	Current Transformer 1 Function	86
367	<i>ct.1v.</i>	Current Transformer 1 Value	86
368	<i>H.b.1r.</i>	Heater Break Alarm 1 Reference Command	86
369	<i>H.b.1t.</i>	Heater Break Alarm 1 Threshold	86
370	<i>oc.1t.</i>	Overcurrent 1 Alarm Threshold	86
371	<i>H.b.1d.</i>	Heater Break Alarm 1 Delay	86
372÷376		Reserved Parameters - Group I1	86

GROUP I2 - *ct 2* - Current Transformer 2

377	<i>ct.2F.</i>	Current Transformer 2 Function	86
378	<i>ct.2v.</i>	Current Transformer 2 Value	86
379	<i>H.b.2r.</i>	Heater Break Alarm 2 Reference Command	86
380	<i>H.b.2t.</i>	Heater Break Alarm 2 Threshold	86
381	<i>oc.2t.</i>	Overcurrent 2 Alarm Threshold	87
382	<i>H.b.2d.</i>	Heater Break Alarm 2 Delay	87
383÷387		Reserved Parameters - Group I2	87

GROUP J1 - *Ro. 1* - Retransmission 1

388	<i>rtR.1</i>	Retransmission 1	87
389	<i>r.1tY.</i>	Retransmission 1 Type	87
390	<i>r.1.L.L.</i>	Retransmission 1 Lower Limit	87
391	<i>r.1.U.L.</i>	Retransmission 1 Upper Limit	87
392	<i>r.1S.E.</i>	Retransmission 1 State Error	88
393	<i>r.1S.S.</i>	Retransmission 1 State Stop	88
394÷398		Reserved Parameters - Group J1	88

GROUP J2 - *Ro. 2* - Retransmission 2 (only on ATR444-24ABC-T)

399	<i>rtR.2</i>	Retransmission 2	88
400	<i>r.2tY.</i>	Retransmission 2 Type	88
401	<i>r.2.L.L.</i>	Retransmission 2 Lower Limit	89
402	<i>r.2.U.L.</i>	Retransmission 2 Upper Limit	89
403	<i>r.2S.E.</i>	Retransmission 2 State Error	89
404	<i>r.2S.S.</i>	Retransmission 2 State Stop	89
405÷409		Reserved Parameters - Group J2	89

GROUP K1 - *5Er.* - Serial (only on ATR444-14ABC-T and ATR444-24ABC-T)

410	<i>SLAd.</i>	Slave Address	89
411	<i>bd.rt.</i>	Baud Rate	89
412	<i>S.P.P.</i>	Serial Port Parameters	89

413	<i>SE.dE.</i>	Serial Delay	90
414	<i>oFF.L.</i>	Off Line	90
415÷419		Reserved Parameters - Group K1	90
GROUP L1 - <i>tMr</i> - Timer			
420	<i>tMr.1</i>	Timer 1	90
421	<i>t.b.t.1</i>	Time Base Timer 1	90
422	<i>A.tA.1</i>	Action Timer 1	90
423	<i>tMr.2</i>	Timer 2	90
424	<i>t.b.t.2</i>	Time Base Timer 2	90
425	<i>A.tA.2</i>	Action Timer 2	90
426	<i>tMr.S.</i>	Timers Sequence	90
427	<i>MAR.</i>	Maintenance Request	91
428	<i>M.t.M.</i>	Maintenance Time	91
429÷431		Reserved Parameters - Group L1	91

Read carefully the safety guidelines and programming instructions contained in this manual before using/connecting the device.

Prima di utilizzare il dispositivo leggere con attenzione le informazioni di sicurezza e settaggio contenute in questo manuale.

Avant d'utiliser le dispositif lire avec attention les renseignements de sûreté et installation contenus dans ce manuel.



PIXSYS s.r.l.

www.pixsys.net

sales@pixsys.net - support@pixsys.net

online assistance: <http://forum.pixsys.net>

via Po, 16 I-30030

Mellaredo di Pianiga, VENEZIA (IT)

Tel +39 041 5190518



2300.10.311-RevB

Rev. firmware 1.03

010721