

SINTESE

BRASS BALL VALVES

USE

- zone heating / cooling systems
- HVAC
- drinking water systems
- systems using alternative energy
- thermal solar systems, with suitable ball valve
- household automation systems

KEY FEATURES

- fast push connection with the actuator
- male connections with tangs and caps
- suitable for interception, adjustment and mixing
- compliant with the Decree of the Ministry of Health N° 174 dd 06/04/2004

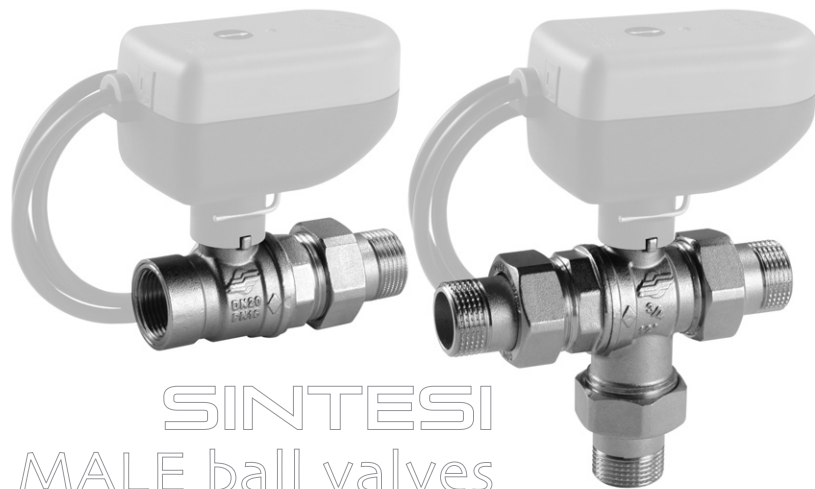

SINTESE
MALE ball valves

VERSIONS

2-WAY ball valve	DN	Connections	PN	Kv _s [m³/h]	Code
------------------	----	-------------	----	------------------------	------



15	1/2" M	16	16,3	SC2A2A
20	3/4" M	16	29,5	SC2B2A
25	1" M	16	43	SC2C2A



15	1/2" MF	16	16,3	SC2A2A9
20	3/4" MF	16	29,5	SC2B2A9
25	1" MF	16	43	SC2C2A9

3-WAY ball valve VERTICAL TYPE	DN	Connections	PN	Kv _s [m³/h]	Code
--------------------------------	----	-------------	----	------------------------	------



MIXER / DIVERTER 90° 3 HOLES					
15	1/2" M	16	6	SC3A3A	
20	3/4" M	16	11,5	SC3B3A	
25	1" M	16	18,3	SC3C3A	

BY-PASS ball valve	DN	Connections	PN	Kv _s [m³/h]	Code
--------------------	----	-------------	----	------------------------	------



15	1/2" M	16	16,3 / 0,8	SC4A4A
20	3/4" M	16	29,5 / 1,9	SC4B4A
25	1" M	16	43 / 2,9	SC4C4A

2-WAY SQUARED ball valve	DN	Connections	PN	Kv _s [m³/h]	Code
--------------------------	----	-------------	----	------------------------	------



20	3/4" MF	16	11,5	SC2B2A9L
----	---------	----	------	----------

2-WAY ball valve EQUAL PERCENTAGE	DN	Connections	PN	Kv _s [m³/h]	Code
-----------------------------------	----	-------------	----	------------------------	------



WITH REGULATING DISC					
15	1/2" M	16	2,5	SC2A2AK2	
15	1/2" M	16	4,0	SC2A2AK4	

3-WAY ball valve MIXER	DN	Connections	PN	Kv _s [m³/h]	Code
------------------------	----	-------------	----	------------------------	------



MIXER 90° 3 HOLES					
20	3/4" M	16	11,5	SC3B3L	

NOT SUITABLE FOR A DIVERTING ACTION

2-WAY SOLAR THERMAL ball valve	DN	Connections	PN	Kv _s [m³/h]	Code
--------------------------------	----	-------------	----	------------------------	------



15	1/2" M	16	16,3	SC2A2ASD1
20	3/4" M	16	29,5	SC2B2ASD1
25	1" M	16	43	SC2C2ASD1

3-WAY SOLAR THERMAL ball valve	DN	Connections	PN	Kv _s [m³/h]	Code
--------------------------------	----	-------------	----	------------------------	------



MIXER / DIVERTER 90° 3 HOLES					
15	1/2" M	16	6	SC3A3ASD1	
20	3/4" M	16	11,5	SC3B3ASD1	
25	1" M	16	18,3	SC3C3ASD1	

For all valves the max differential pressure value coincides with PN



SINTESE

BRASS BALL VALVES

TECHNICAL FEATURES

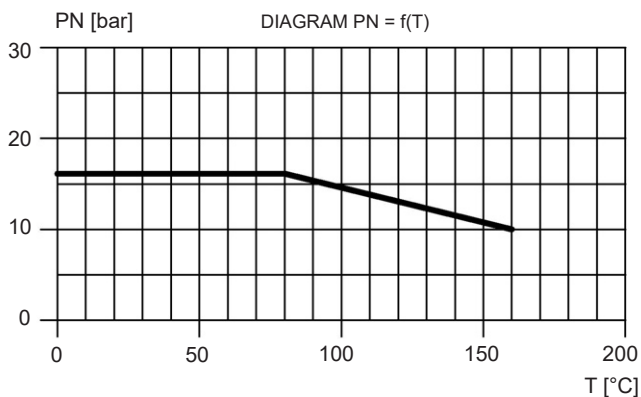

When the value of the flow is known, the general expression for the calculation of pressure losses is the following:

$$\Delta p \text{ [bar]} = \left[\frac{Q \text{ [m}^3\text{/h]}}{k_{vs}} \right]^2$$

The expression provided applies to water or technically similar fluids.

FLUIDS Water (maximum 30% glycol)

FLUID TEMPERATURES

	STANDARD valves	Valves for THERMAL SOLAR SYSTEMS
• Minimum	+5 °C	+5 °C
• Maximum	+100 °C	+160 °C

COMPLIANCE

These ball valves are compliant with the Decree of the Ministry of Health N° 174 dd 06/04/2004.

FUNCTIONING

- **INTERCEPTION AND DIVERTING ACTION:** 2-WAY/3-WAY VERTICAL TYPE/BY-PASS and 2-WAY SQUARE ball valves coupled with a 2-point or 3-point **SINTESE** actuator can intercept or divert the fluid.
- **REGULATION AND MIXING:** the 2-WAY, 3-WAY VERTICAL ball valves and THE 3-WAY MIXER ball valve coupled with a 2-point or 3-point **SINTESE** actuator are used for partialising or for mixing the fluid. Moreover, the 2-way ball valve equal percentage type are supplied with a regulation disc making the curve equal percentage: generally, the thermal exchange is described as a typical not linear relationship between flow rate and exchanged heat. By using ball valves with equal percentage feature, it is possible to compensate the non-linearity and to obtain an installed characteristic curve as shown below. In this way, by working on a constant gain system, we do have positive effects on regulation also in terms of stability.

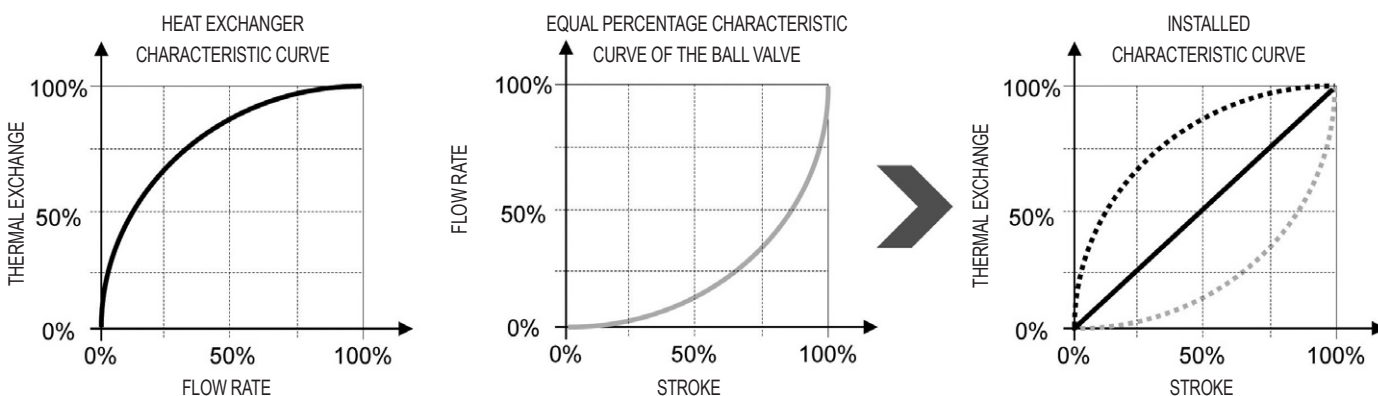

Note that the presence of the adjustment disc reduces the flow coefficient to values which are similar to those of traditional regulating valves. With the adjustment disc, the SINTESE valve becomes a regulating valve, adding several advantages:

- Great stability of the control ring;
- Flow coefficient similar to that of traditional regulating valves;
- Equal-percentage standardized feature;
- Fewer operations of the actuator.

CAUTION: the 2-way valve with regulation disc can not be mounted regardless of the flow direction: first, observe the position of the disc inside the ball valve (see picture beside), then proceed with the installation so that the regulation disc is upstream the valve ball with respect to the flow direction.



SINTESI

BRASS BALL VALVES

3 WAY DIVERTER / MIXER BALL VALVE

Have a 3-hole ball with one hole pointed towards the common way (always open) and two more holes which are orthogonal to the first one and to each other. When one of these two holes is pointed towards one of the two inlets, the second inlet is closed.

By means of a rotation of 90° of the ball, the second hole points towards the second inlet and closes the first one. One of the special features of the 3-hole ball valve is the fact that the 3 ways can communicate simultaneously, during the ball rotation from one deviation position to another. At the end of the operation, the valve is a diverter again, for all practical purposes; therefore, the use of the 3-way 3-hole diverter valve is advisable when the diverted ways can communicate.

This is generally the case of heating systems. Moreover, the above mentioned condition allows this valve to be used for mixing. On the control rod there are **two symbols (a couple of dots and a dash)** which indicate which way is communicating to the common one.

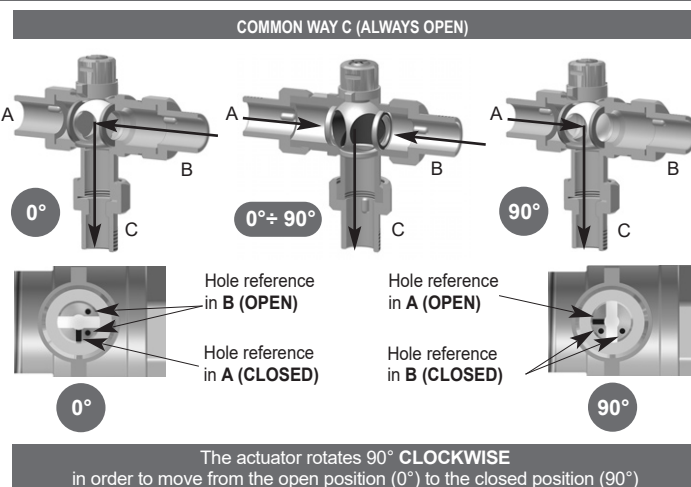

3-WAY MIXER BALL VALVE

Feature a ball with 3 holes suitably positioned as a "T" to ensure the mixing function on the AB common way.

On the control rod there are **three symbols (two dots and a dash)** which indicate which way is communicating to the common one.

BALL VALVE TO BE USED FOR MIXING ONLY



NOT SUITABLE FOR USE AS A DIVERTER: THE TIGHTNESS OF THE "A" WAY IS NOT GUARANTEED.

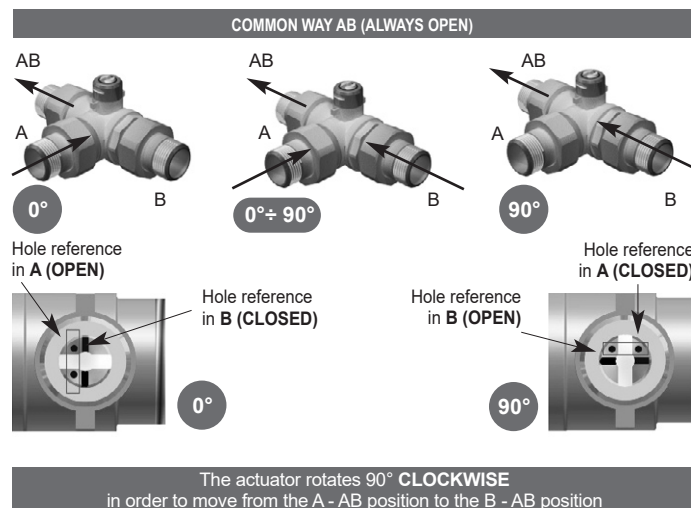

BY-PASS BALL VALVE

The feature that distinguishes the by-pass ball from the 2-way ball is a milling which allows the recirculation of part of the outlet flow towards the return line when the valve is closed. Therefore, in by-pass valves it is important to recognize the flow direction.

On the control rod there is a symbol (a dash) which indicates the position of the faceting on the ball; when the valve is closed, it must always be oriented towards the direction of the incoming flow.

The span between the outlet and return ways can be adjusted from 50 mm to 60 mm for Ø1/2" and 3/4" ball valves and from 55 mm to 60 mm for Ø 1" ball valves.

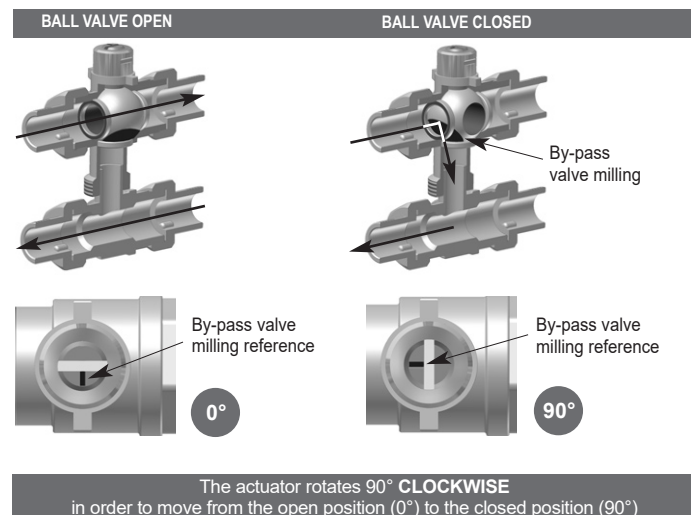

SINTESI

BRASS BALL VALVES

EXAMPLE OF USE

Adjustment by means of a 2-way valve with disk.

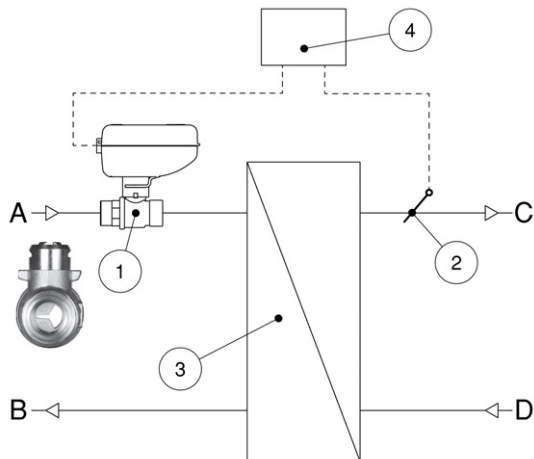

- A** : Primary fluid outlet
- B** : Primary fluid return
- C** : Secondary fluid outlet
- D** : Secondary fluid return

- 1** : 3-POINT **SINTESI** motorized valve with regulation disc
- 2** : Temperature probe
- 3** : Heat exchanger
- 4** : Electronic adjuster

CONSTRUCTION CHARACTERISTICS

Male connections are all provided with tang, which is extremely convenient during the installation and allows to position the ball valve and then the actuator properly; moreover, it helps performing any maintenance work. The ball cut-off ensures the best hydraulic tightness and reduced pressure loss.

MATERIAL USED

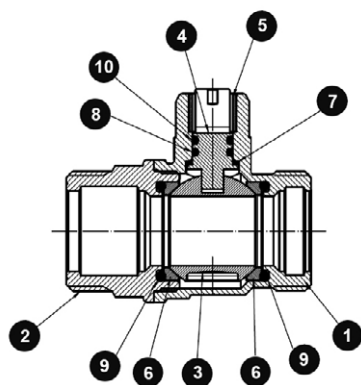

1	BODY	BRASS CW 617N - UNI EN 12420 / NICKEL PLATING
2	COUPLING	BRASS CW 617N - UNI EN 12420 / NICKEL PLATING
3	BALL	BRASS CW 617N - UNI EN 12420 / CHROMED NICKEL
4	ROD	BRASS CW 614N - UNI EN 12164 / NICKEL PLATING
5	SLEEVE	P.T.F.E.
6	BALL SEAL.	P.T.F.E. *
7	ATIFRICTION SEAL	P.T.F.E. *
8	ROD O-RING	EPDM
9	O-RING	EPDM PEROX **
10	ROD UPPER O-RING	EPDM

* P.T.F.E. + graphite 15% for solar thermal versions

** Red FKM for solar thermal versions

OVERALL SIZE

ACTUATOR

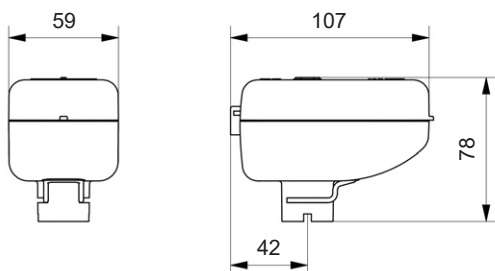

SIZES ARE VALID FOR:

- SINTESI
- SINTESI SMART
- SINTESI SMART MODBUS
- SINTESI DC



SINTESE

BRASS BALL VALVES

OVERALL SIZE

BALL VALVES

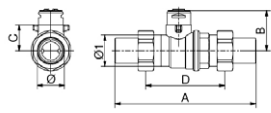
MODEL	DN	Ø UNIONS	Ø 1 BALL VALVES	A	B	C	D	E	F
2-way MM 	NOTE: size of 1/2" ball valves are the same also for 2-way ball valves with regulation disc								
	15	1/2"	3/4"	117	33	21	63		
	20	3/4"	1"	128	38	26	67		
25	1"	1"1/4"	147	41	29	77			

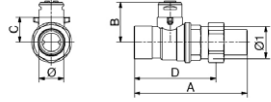
MODEL	DN	Ø UNIONS	Ø 1 BALL VALVES	A	B	C	D	E	F
2-way MF 	15	1/2"	3/4"	94	33	21	67		
	20	3/4"	1"	101	38	26	71		
	25	1"	1"1/4"	114	41	29	79		

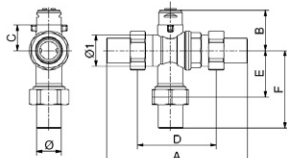
MODEL	DN	Ø UNIONS	Ø 1 BALL VALVES	A	B	C	D	E	F
3-way MMM Diverter Mixer 	15	1/2"	3/4"	117	33	21	63	38	64
	20	3/4"	1"	128	38	26	67	40	70
	25	1"	1"1/4"	147	41	29	77	42	77

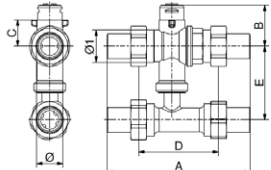
MODEL	DN	Ø UNIONS	Ø 1 BALL VALVES	A	B	C	D	E	F
By-pass 	15	1/2"	3/4"	117	33	21	63	da 50 a 60	
	20	3/4"	1"	128	38	26	67	da 50 a 60	
	25	1"	1"1/4"	147	41	29	77	da 55 a 60	

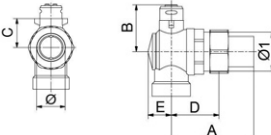
MODEL	DN	Ø UNIONS	Ø 1 BALL VALVES	A	B	C	D	E	F
2-way MF square body 	20	3/4"	1"	71	38	26	40	20	

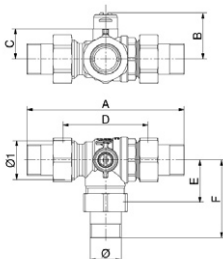
MODEL	DN	Ø UNIONS	Ø 1 BALL VALVES	A	B	C	D	E	F
3-way MMM Mixer 	20	3/4"	1"	133	38	26	72	36	67

D - E: dimensions referred to the ball valve without unions
C: to be taken into account when coupling the actuator to the ball valve

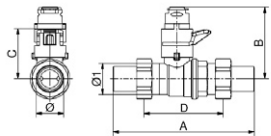
MODEL	DN	Ø UNIONS	Ø 1 BALL VALVES	A	B	C	D	E	F
2-way MM for SOLAR THERMAL systems 	15	1/2"	3/4"	117	59	45	63		
	20	3/4"	1"	128	63	50	67		
	25	1"	1"1/4"	147	66	53	77		

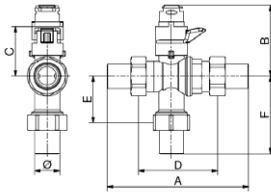
MODEL	DN	Ø UNIONS	Ø 1 BALL VALVES	A	B	C	D	E	F
3-way MMM Diverter Mixer for SOLAR THERMAL systems 	15	1/2"	3/4"	117	59	45	63	38	64
	20	3/4"	1"	128	63	50	67	40	70
	25	1"	1"1/4"	147	66	53	77	42	77

D - E: dimensions referred to the ball valve without unions
C: to be taken into account when coupling the actuator to the ball valve



SINTESI

BRASS BALL VALVES

ACCESSORIES

The 2-way and 3-way diverting/mixing **SINTESI** ball valves can be insulated by means of a shell in closed-cell cross-linked expanded polyethylene.

INSULATION **2-WAY**



2-WAY ball valve with insulation



Ball valves	Code
DN 15 - G 1/2" M	CBSC2A2A
DN 20 - G 3/4" M	CBSC2B2A
DN 25 - G 1" M	CBSC2C2A

INSULATION **3-WAY**



3-WAY ball valve with insulation



Ball valves	Code
DN 15 - G 1/2" M	CBSC3A3A
DN 20 - G 3/4" M	CBSC3B3A
DN 25 - G 1" M	CBSC3C3A

EXAMPLE OF SPECIFICATIONS

SINTESI BRASS BALL VALVE • CW617N UNI EN 12165, EPDM and PTFE seals, full port, PN16, with tangs and caps, UNI EN 10226-1 threads. Operating temperatures +5°C...+100°C. Fluid type: water with glycol max. 30%. Connection to the actuator with a Sintesi fast connection. Version: 2-way MM DN15 - 1/2" - Kvs 16,3.

Brand: **COMPARATO**

Code: **SC2A2A**

UPDATED DATA SHEETS AVAILABLE AT www.comparato.com

In order to provide an up-to-date service, Comparato Nello S.r.l. reserves the right to modify technical data, drawings, graphs and photos of this data sheet at any time, without prior notice.

BIM
BUILDING
INFORMATION
MODELING



HYDROTHERMAL SYSTEMS
COMPARATO NELLO S.r.l.

17014 CAIRO MONTENOTTE (SV) ITALIA VIALE DELLA LIBERTÀ • LOCALITÀ FERRANIA • Tel. +39 019 510.371 - FAX +39 019 517.102

www.comparato.com

e-mail: info@comparato.com

UNI EN ISO 9001:2015 CERTIFIED COMPANY