

» G 30.0 | G 30.0S | cont. 10 W, peak 16 W

- » Mechanical commutation through multi bar commutator provides long lifetime
- » Operation in both directions of rotation
- » Ball bearing at motor output shaft is standard
- » Optionally with ball bearing on both sides, shaft on both sides, custom shaft length and diameter, lead version, special winding on request

- » Mechanische Kommutierung über vierteiligen Kollektor bietet lange Lebensdauer
- » Drehrichtung Rechts-/ Linkslauf
- » Motorwelle abtriebsseitig kugellagert ist Standard
- » Optional beidseitig kugellagert, beidseitige Welle, abweichende Wellenlängen und -durchmesser, Litzenausführung, Sonderwicklung auf Anfrage



Supply voltage versions	High efficiency	Low noise	Protection class (up to)	Interference suppression optional	Vibration resistance

Data/ Technische Daten		G 30.0			G 30.0S		
Nominal voltage/ Nennspannung	VDC	12	24	40	12	24	40
Nominal current/ Nennstrom	A ^{*)}	1.4	0.71	0.4	1.40	0.71	0.40
Nominal torque/ Nennmoment	Nm ^{*)}	0.03	0.03	0.03	0.0370	0.0370	0.0370
Nominal speed/ Nenndrehzahl	rpm ^{*)}	2980	3030	2810	2500	2650	2600
Stall torque/ Anhaltmoment	Nm ^{*)}	0.129	0.13	0.123	0.153	0.17	0.165
Maximum torque/ Maximales Moment	Nm ^{*)}	0.129	0.13	0.123	0.153	0.17	0.165
No load speed/ Leerlaufdrehzahl	rpm ^{*)}	4130	4400	4100	3250	3550	3350
Nominal output power/ Dauerabgabeleistung	W ^{*)}	9.4	9.5	8.8	9.7	10.27	10.1
Maximum output power/ Maximale Abgabeleistung	W	13.93	14.9	13.2	13.02	15.8	14.9
Torque constant/ Drehmomentkonstante	Nm A ^{-1**)}	0.0288	0.05	0.0873	0.0336	0.0636	0.1102
Terminal Resistance/ Anschlusswiderstand	Ω	2.61	8.9	27.4	2.55	8.73	26.4
Terminal inductance/ Anschlussinduktivität	mH	2.61	8.0	24.7	2.61	7.42	24.7
Starting current/ Anlaufstrom	A ^{*)}	4.6	2.7	1.46	4.7	2.75	1.52
No load current/ Leerlaufstrom	A ^{*)}	0.25	0.13	0.07	0.25	0.14	0.075
Demagnetisation current/ Entmagnetisierungsstrom	A ^{*)}	≥ 11.5	≥ 6.0	≥ 3.0	-	-	-
Rotor inertia/ Rotor Trägheitsmoment	gcm ²	42.2	41.9	42.2	42	41.9	42.2
Weight of motor/ Motorgewicht	kg	0.24	0.24	0.24	0.24	0.24	0.24

*) Δθ_w = 100 K; **) θ_R = 20°C ***) at nominal point/ im Nennpunkt

Modular System/ Modulares Baukastensystem

» Brakes/ Bremsen

- E 38 R

» Encoder/ Geber

- MG 2
- RE 22
- RE 30 (T1)

» Controller/ Regelelektroniken

- RS 200
- BGE 6005 A
- BGE 6010 A

» Planetary Gearboxes/ Planetengetriebe

- PLG 30
- PLG 32
- PLG 42 K
- PLG 42 S

You can individually configure your suitable product and download technical data and drawings for the combination at www.dunkermotoren.com/en/configuration/
 Unter www.dunkermotoren.de/konfigurator können Sie Ihr passendes Produkt individuell konfigurieren und technische Daten und Zeichnung für die Kombination herunterladen.

Dimensions in mm/ Maßzeichnung in mm

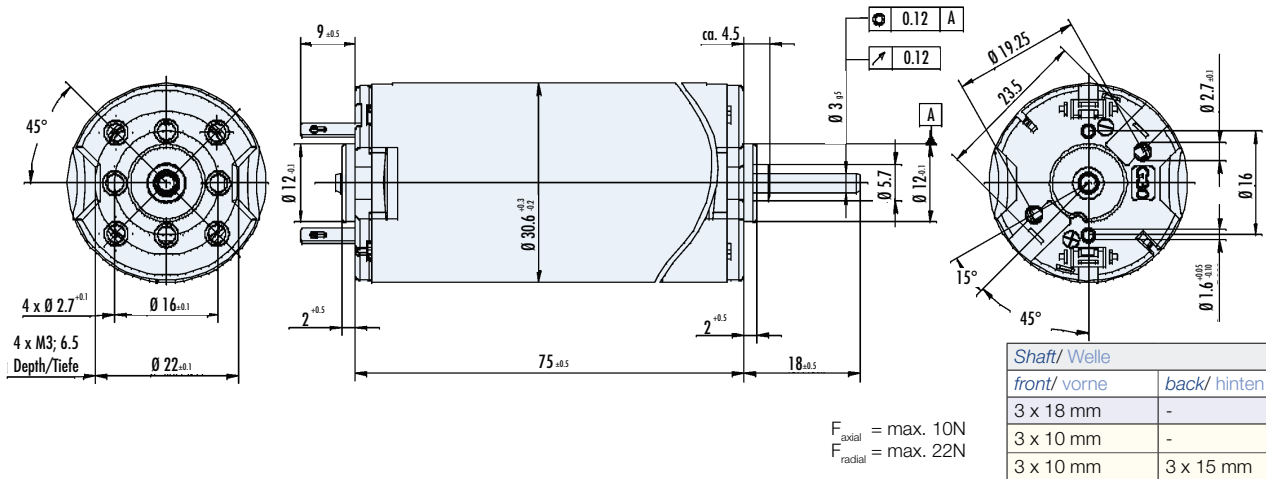

Characteristic diagram/ Belastungskennlinien

In accordance with/ Belastungskennlinien gezeichnet nach EN 60034

■ Continuous operation/ Dauerbetrieb
 ■ Cyclical operation/ Zykl. Betrieb
 — Current torque/ Strom-Drehmoment — Speed torque/ Drehzahl-Drehmoment — Efficiency/ Effizienz

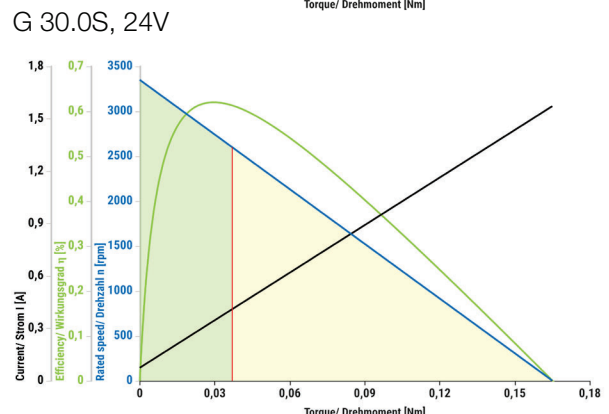
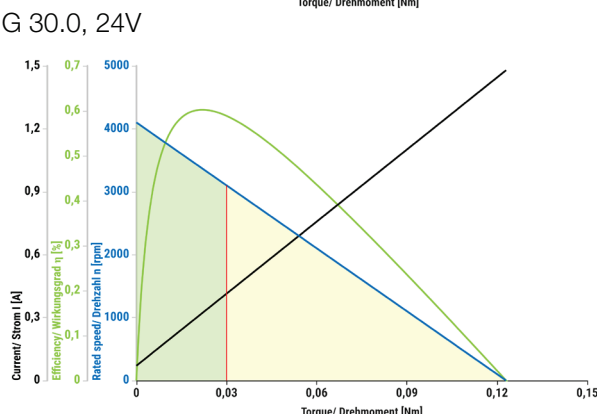
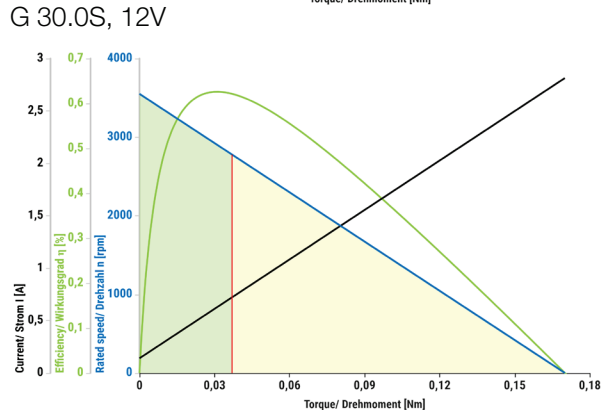
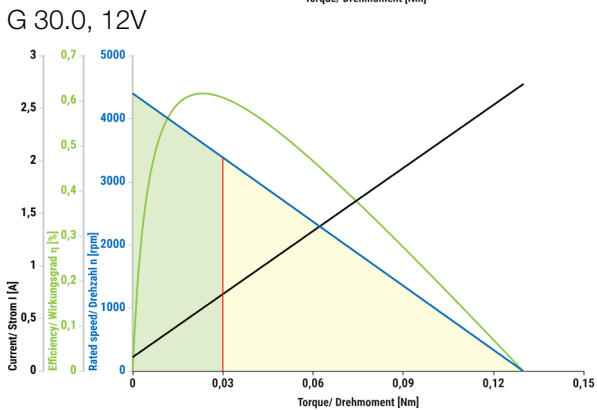
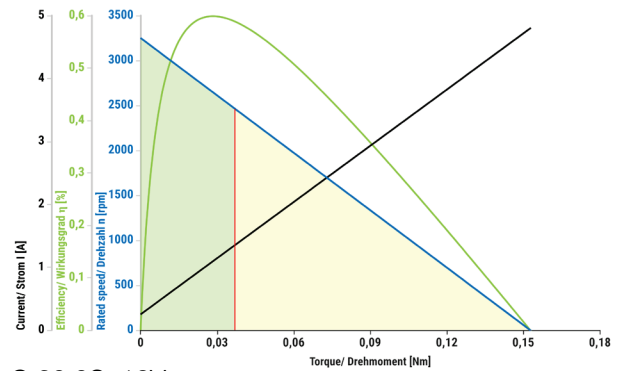
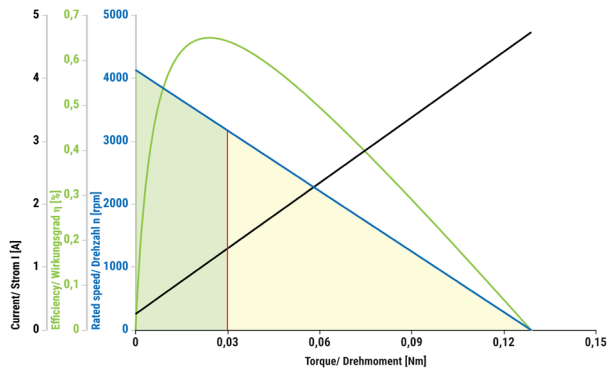

■ Preferred series/ Vorzugsreihe
 ■ Standard product/ Standardprodukt
 ■ On request/ auf Anfrage
 See notes page 8/ Hinweise siehe S. 8