

Series CD04

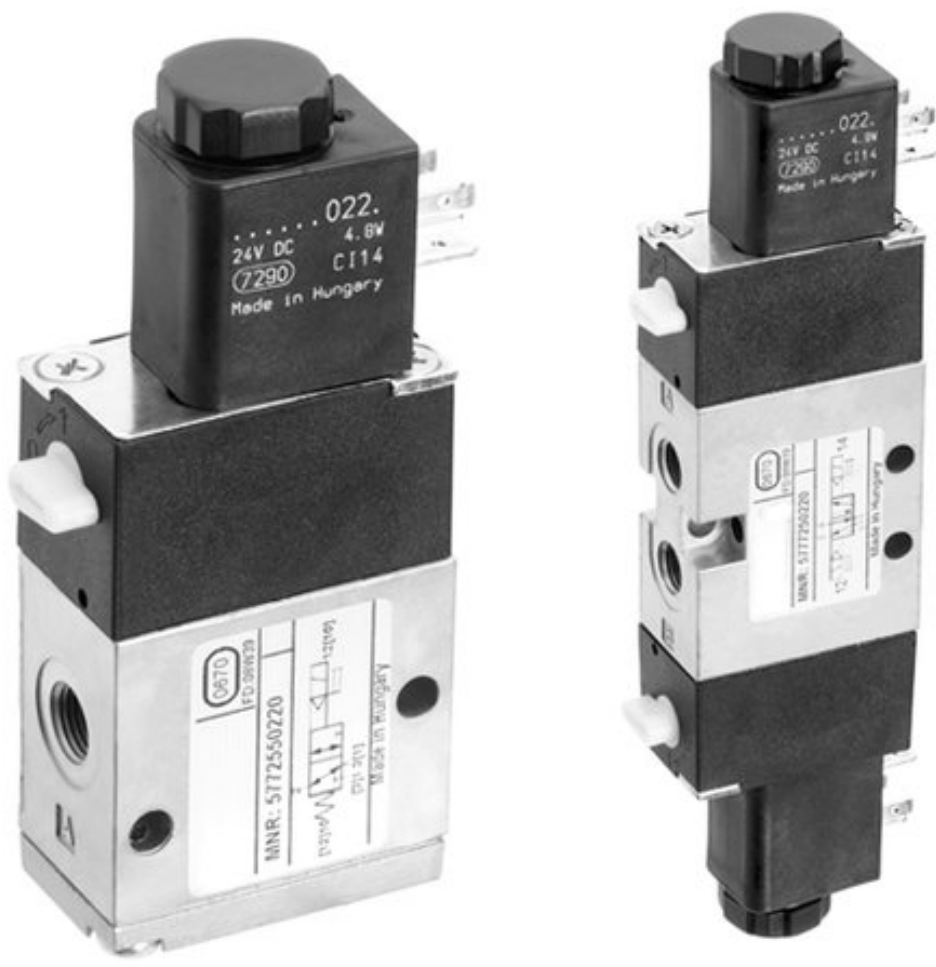

AVENTICS™ Series CD04





















3/2-directional valve, Series CD04

- 3/2
- Qn = 900 l/min
- Pilot valve width : 26 mm
- NC NO
- Pipe connection
- Compressed air connection output : G 1/8
- Electrical connection : Plug, EN 175301-803, form B, 3-pin
- Manual override : with detent without
- single solenoid
- With spring return
- Pilot : Internal External



Version	Spool valve, positive overlapping
Activation	Electrically
Sealing principle	Soft sealing
Working pressure min./max.	See table below
Control pressure min./max.	See table below
Ambient temperature min./max.	See table below
Medium temperature min./max.	See table below
Medium	Compressed air
Max. particle size	50 µm
Oil content of compressed air	0 ... 1 mg/m ³
Nominal flow Qn	900 l/min
Nominal flow 1 ► 2	900 l/min
Nominal flow 2 ► 3	900 l/min
Compressed air connection	according to ISO 228-1
Pilot control exhaust	with directional pilot air exhaust
Connector standard	EN 175301-803:2006
Protection class with connection	IP65
Compatibility index	14
Duty cycle	100 %
Weight	See table below

Technical data

Part No.		MO		Compressed air connection	
				Input	
5772550220			NC NO		G 1/8
5772555270			NC NO		G 1/8
5772555280			NC NO		G 1/8
5772555220			NC NO		G 1/8
5772555302			NC NO		G 1/8
5772560220			NC NO		G 1/8
5772565270			NC NO		G 1/8
5772565280			NC NO		G 1/8
5772565302			NC NO		G 1/8
5772590220		—	NC NO		G 1/8

Part No.	Compressed air connection	
	Output	Exhaust
5772550220	G 1/8	G 1/8
5772555270	G 1/8	G 1/8
5772555280	G 1/8	G 1/8
5772555220	G 1/8	G 1/8
5772555302	G 1/8	G 1/8
5772560220	G 1/8	G 1/8
5772565270	G 1/8	G 1/8
5772565280	G 1/8	G 1/8
5772565302	G 1/8	G 1/8
5772590220	G 1/8	G 1/8

Part No.	Compressed air connection	
	Pilot Input	Pilot Exhaust
5772550220	-	M5
5772555270	-	M5
5772555280	-	M5
5772555220	-	M5
5772555302	-	M5
5772560220	G 1/8	M5
5772565270	G 1/8	M5
5772565280	G 1/8	M5
5772565302	G 1/8	M5
5772590220	-	M5

Part No.	Operational voltage		
	DC	AC 50 Hz	AC 60 Hz
5772550220	24 V	-	-
5772555270	-	110 V	110 V
5772555280	-	230 V	230 V
5772555220	-	24 V	24 V
5772555302	-	-	-
5772560220	24 V	-	-
5772565270	-	110 V	110 V

Part No.	Operational voltage	Operational voltage	Operational voltage
	DC	AC 50 Hz	AC 60 Hz
5772565280	-	230 V	230 V
5772565302	-	-	-
5772590220	24 V	-	-

Part No.	Voltage tolerance	Voltage tolerance	Voltage tolerance	Power consumption
	DC	AC 50 Hz	AC 60 Hz	DC
5772550220	-10% / +10%	-	-	4.8 W
5772555270	-	-20% / +10%	-10% / +20%	-
5772555280	-	-20% / +10%	-10% / +20%	-
5772555220	-	-20% / +10%	-10% / +20%	-
5772555302	-	-	-	-
5772560220	-10% / +10%	-	-	4.8 W
5772565270	-	-20% / +10%	-10% / +20%	-
5772565280	-	-20% / +10%	-10% / +20%	-
5772565302	-	-	-	-
5772590220	-30% / +30%	-	-	8.4 W

Part No.	Holding power	Holding power	Switch-on power	Switch-on power	Pilot
	AC 50 Hz	AC 60 Hz	AC 50 Hz	AC 60 Hz	
5772550220	-	-	-	-	Internal
5772555270	8.3 VA	7.2 VA	10.8 VA	9.5 VA	Internal
5772555280	7.9 VA	6.4 VA	10.6 VA	8.9 VA	Internal
5772555220	8.3 VA	6.7 VA	10.8 VA	9.4 VA	Internal
5772555302	-	-	-	-	Internal
5772560220	-	-	-	-	External
5772565270	8.3 VA	7.2 VA	10.8 VA	9.5 VA	External
5772565280	7.9 VA	6.4 VA	10.6 VA	8.9 VA	External
5772565302	-	-	-	-	External
5772590220	-	-	-	-	Internal

Part No.	Working pressure min./max.	Control pressure min./max.	Ambient temperature min./max.
5772550220	3 ... 10 bar	3 ... 10 bar	-15 ... 50 °C
5772555270	3 ... 10 bar	3 ... 10 bar	-15 ... 50 °C
5772555280	3 ... 10 bar	3 ... 10 bar	-15 ... 50 °C
5772555220	3 ... 10 bar	3 ... 10 bar	-15 ... 50 °C
5772555302	3 ... 10 bar	3 ... 10 bar	-15 ... 50 °C
5772560220	-0.95 ... 10 bar	3 ... 10 bar	-15 ... 50 °C
5772565270	-0.95 ... 10 bar	3 ... 10 bar	-15 ... 50 °C
5772565280	-0.95 ... 10 bar	3 ... 10 bar	-15 ... 50 °C
5772565302	-0.95 ... 10 bar	3 ... 10 bar	-15 ... 50 °C
5772590220	2.6 ... 10 bar	2.6 ... 10 bar	-20 ... 80 °C

Part No.	Medium temperature min./max.	Typ. switch-on time	Typ. switch-off time
5772550220	-15 ... 50 °C	13 ms	27 ms
5772555270	-15 ... 50 °C	13 ms	27 ms
5772555280	-15 ... 50 °C	13 ms	27 ms
5772555220	-15 ... 50 °C	13 ms	27 ms

Part No.	Medium temperature min./max.	Typ. switch-on time	Typ. switch-off time
5772555302	-15 ... 50 °C	-	-
5772560220	-15 ... 50 °C	13 ms	27 ms
5772565270	-15 ... 50 °C	13 ms	27 ms
5772565280	-15 ... 50 °C	13 ms	27 ms
5772565302	-15 ... 50 °C	-	-
5772590220	-20 ... 80 °C	13 ms	27 ms

Part No.	basic valve with electrical connector	Power consumption	Weight	
5772550220	-	-	0.3 kg	1)
5772555270	-	-	0.3 kg	1)
5772555280	-	-	0.3 kg	1)
5772555220	-	-	0.3 kg	1)
5772555302	Basic valve without coil	-	0.25 kg	1)
5772560220	-	-	0.3 kg	1)
5772565270	-	-	0.3 kg	1)
5772565280	-	-	0.3 kg	1)
5772565302	Basic valve without coil	-	0.25 kg	1)
5772590220	-	Higher voltage tolerance	0.3 kg	2)

Nominal flow Qn at 6 bar and $\Delta p = 1$ bar, MO = Manual override

1) Pilot valve material: polyamide, fiberglass reinforced

2) Pilot valve material: aluminum

Technical information

The min. control pressure must be adhered to, since otherwise faulty switching and valve failure may result!

The pressure dew point must be at least 15 °C under ambient and medium temperature and may not exceed 3 °C .

The oil content of compressed air must remain constant during the life cycle.

Use only the approved oils from AVENTICS. Further information can be found in the "Technical information" document (available in the MediaCentre).

option valve: The input and output compressed air connections can be exchanged.

The valve can thereby be used in the NC or NO operating mode.

Technical information

Material	
Housing	Die cast zinc Polyamide fiber-glass reinforced
Seals	Acrylonitrile butadiene rubber

Dimensions

Dimensions

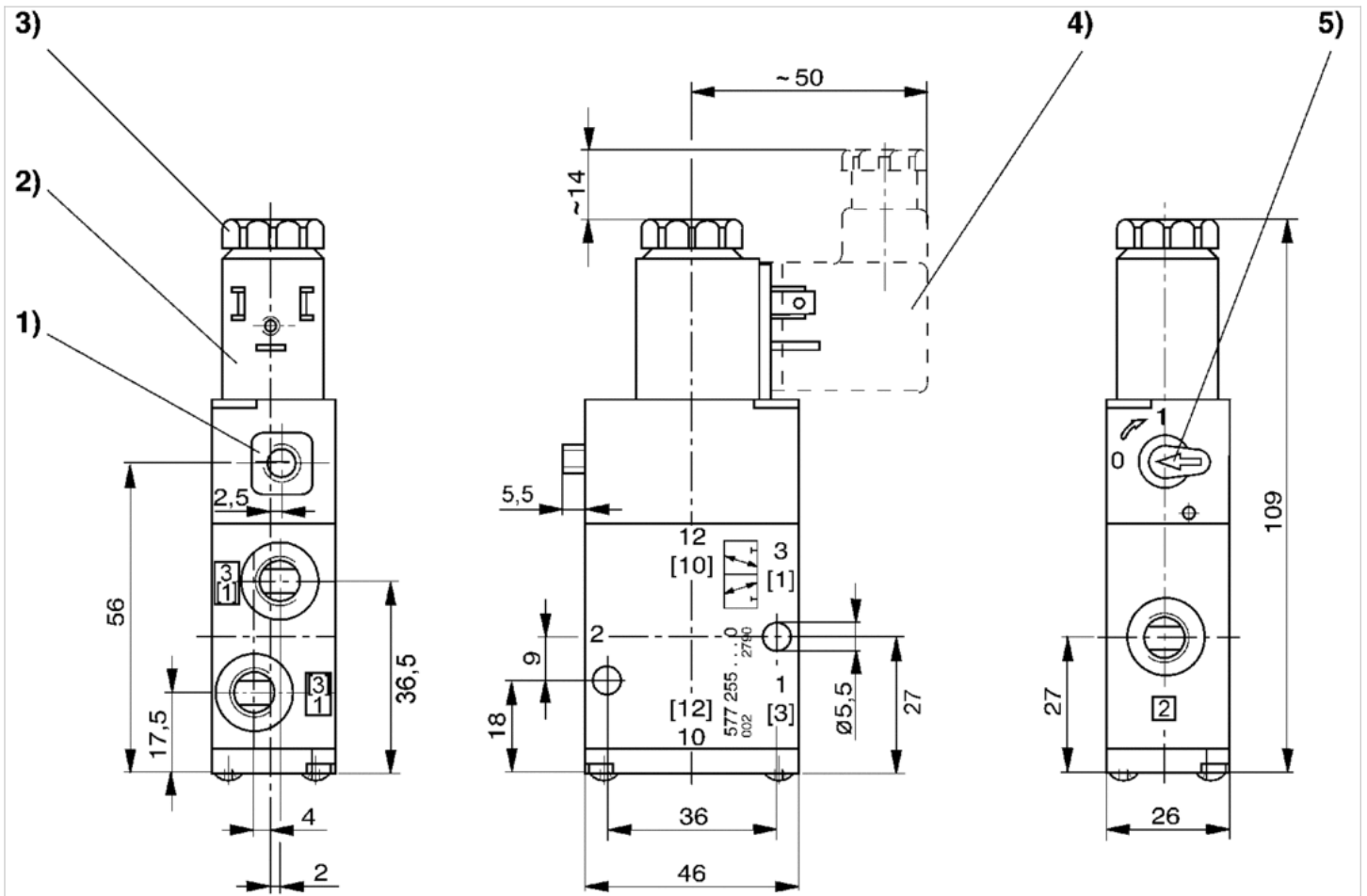

1) Only with separate pilot control G 1/8 2) Coil can be rotated at 90° intervals 3) After removal of cap M5 internal thread 4) Valve plug connector can be plugged at 180° intervals 5) Manual override



























5/2-directional valve, Series CD04

- 5/2
- Qn = 900 l/min
- Pilot valve width : 26 mm
- Pipe connection
- Compressed air connection output : G 1/8
- Electrical connection : Plug, EN 175301-803, form B, 3-pin
- Manual override : with detent
- single solenoid
- Pilot : Internal External



Version	Spool valve, positive overlapping
Activation	Electrically
Sealing principle	Soft sealing
Working pressure min./max.	See table below
Control pressure min./max.	3 ... 10 bar
Ambient temperature min./max.	-15 ... 50 °C
Medium temperature min./max.	-15 ... 50 °C
Medium	Compressed air
Max. particle size	50 µm
Oil content of compressed air	0 ... 1 mg/m ³
Nominal flow Qn	900 l/min
Nominal flow 1 ► 2	900 l/min
Nominal flow 2 ► 3	900 l/min
Compressed air connection	according to ISO 228-1
Pilot control exhaust	with directional pilot air exhaust
Connector standard	EN 175301-803:2006
Protection class with connection	IP65
Compatibility index	14
Duty cycle	100 %
Mounting on manifold strip	P-strip
Weight	See table below

Technical data

Part No.		MO	Compressed air connection	
			Input	Output
5777050210			G 1/8	G 1/8
5777050220			G 1/8	G 1/8
5777055270			G 1/8	G 1/8
5777055280			G 1/8	G 1/8
5777055220			G 1/8	G 1/8
5777055302			G 1/8	G 1/8
5777060220			G 1/8	G 1/8
5777065270			G 1/8	G 1/8
5777065280			G 1/8	G 1/8
5777065220			G 1/8	G 1/8
5777065302			G 1/8	G 1/8
5777150220			G 1/8	G 1/8
5777155270			G 1/8	G 1/8

Part No.	Compressed air connection	
	Exhaust	Pilot Input
5777050210	G 1/8	-
5777050220	G 1/8	-
5777055270	G 1/8	-
5777055280	G 1/8	-
5777055220	G 1/8	-
5777055302	G 1/8	-
5777060220	G 1/8	G 1/8
5777065270	G 1/8	G 1/8
5777065280	G 1/8	G 1/8
5777065220	G 1/8	G 1/8
5777065302	G 1/8	G 1/8
5777150220	G 1/8	-
5777155270	G 1/8	-

Part No.	Compressed air connection		Operational voltage	
	Pilot	Exhaust	DC	AC 50 Hz
5777050210	M5	M5	12 V	-
5777050220	M5	M5	24 V	-
5777055270	M5	M5	-	110 V
5777055280	M5	M5	-	230 V
5777055220	M5	M5	-	24 V
5777055302	M5	M5	-	-
5777060220	M5	M5	24 V	-
5777065270	M5	M5	-	110 V
5777065280	M5	M5	-	230 V
5777065220	M5	M5	-	24 V
5777065302	M5	M5	-	-
5777150220	M5	M5	24 V	-
5777155270	M5	M5	-	110 V

Part No.	Operational voltage	Voltage tolerance		
		DC	AC 50 Hz	AC 60 Hz
5777050210	-	-10% / +10%	-	-
5777050220	-	-10% / +10%	-	-
5777055270	110 V	-	-20% / +10%	-10% / +20%
5777055280	230 V	-	-20% / +10%	-10% / +20%
5777055220	24 V	-	-20% / +10%	-10% / +20%
5777055302	-	-	-	-
5777060220	-	-10% / +10%	-	-
5777065270	110 V	-	-20% / +10%	-10% / +20%
5777065280	230 V	-	-20% / +10%	-10% / +20%
5777065220	24 V	-	-20% / +10%	-10% / +20%
5777065302	-	-	-	-
5777150220	-	-10% / +10%	-	-
5777155270	110 V	-	-20% / +10%	-10% / +20%

Part No.	Power consumption		Holding power		Switch-on power
	DC	AC 50 Hz	AC 50 Hz	AC 60 Hz	AC 50 Hz
5777050210	4.6 W	-	-	-	-
5777050220	4.8 W	-	-	-	-
5777055270	-	8.3 VA	7.2 VA	7.2 VA	10.8 VA
5777055280	-	7.9 VA	6.4 VA	6.4 VA	10.6 VA
5777055220	-	8.3 VA	6.7 VA	6.7 VA	10.8 VA
5777055302	-	-	-	-	-
5777060220	4.8 W	-	-	-	-
5777065270	-	8.3 VA	7.2 VA	7.2 VA	10.8 VA
5777065280	-	7.9 VA	6.4 VA	6.4 VA	10.6 VA
5777065220	-	8.3 VA	6.7 VA	6.7 VA	10.8 VA
5777065302	-	-	-	-	-
5777150220	4.8 W	-	-	-	-
5777155270	-	8.3 VA	7.2 VA	7.2 VA	10.8 VA

Part No.	Switch-on power		Pilot	Working pressure min./max.	Typ. switch-on time	Typ. switch-off time
	AC 60 Hz					
5777050210	-		Internal	3 ... 10 bar	12 ms	21 ms
5777050220	-		Internal	3 ... 10 bar	12 ms	21 ms
5777055270	9.5 VA		Internal	3 ... 10 bar	12 ms	21 ms
5777055280	8.9 VA		Internal	3 ... 10 bar	12 ms	21 ms
5777055220	9.4 VA		Internal	3 ... 10 bar	12 ms	21 ms
5777055302	-		Internal	3 ... 10 bar	-	-
5777060220	-		External	-0.95 ... 10 bar	12 ms	21 ms
5777065270	9.5 VA		External	-0.95 ... 10 bar	12 ms	21 ms
5777065280	8.9 VA		External	-0.95 ... 10 bar	12 ms	21 ms
5777065220	9.4 VA		External	-0.95 ... 10 bar	12 ms	21 ms
5777065302	-		External	-0.95 ... 10 bar	-	-
5777150220	-		Internal	3 ... 10 bar	12 ms	21 ms
5777155270	9.5 VA		Internal	3 ... 10 bar	12 ms	21 ms

Part No.	basic valve with electrical connector	Weight
5777050210	-	0.39 kg
5777050220	-	0.39 kg
5777055270	-	0.39 kg
5777055280	-	0.39 kg
5777055220	-	0.39 kg
5777055302	Basic valve without coil	0.34 kg
5777060220	-	0.39 kg
5777065270	-	0.39 kg
5777065280	-	0.39 kg
5777065220	-	0.39 kg
5777065302	Basic valve without coil	0.34 kg
5777150220	-	0.39 kg
5777155270	-	0.39 kg

Nominal flow Qn at 6 bar and $\Delta p = 1$ bar, MO = Manual override

Technical information

The min. control pressure must be adhered to, since otherwise faulty switching and valve failure may result!

The pressure dew point must be at least 15 °C under ambient and medium temperature and may not exceed 3 °C .

The oil content of compressed air must remain constant during the life cycle.

Use only the approved oils from AVENTICS. Further information can be found in the "Technical information" document (available in the MediaCentre).

Technical information

Material	
Housing	Die cast zinc Polyamide fiber-glass reinforced
Seals	Acrylonitrile butadiene rubber

Dimensions

Dimensions

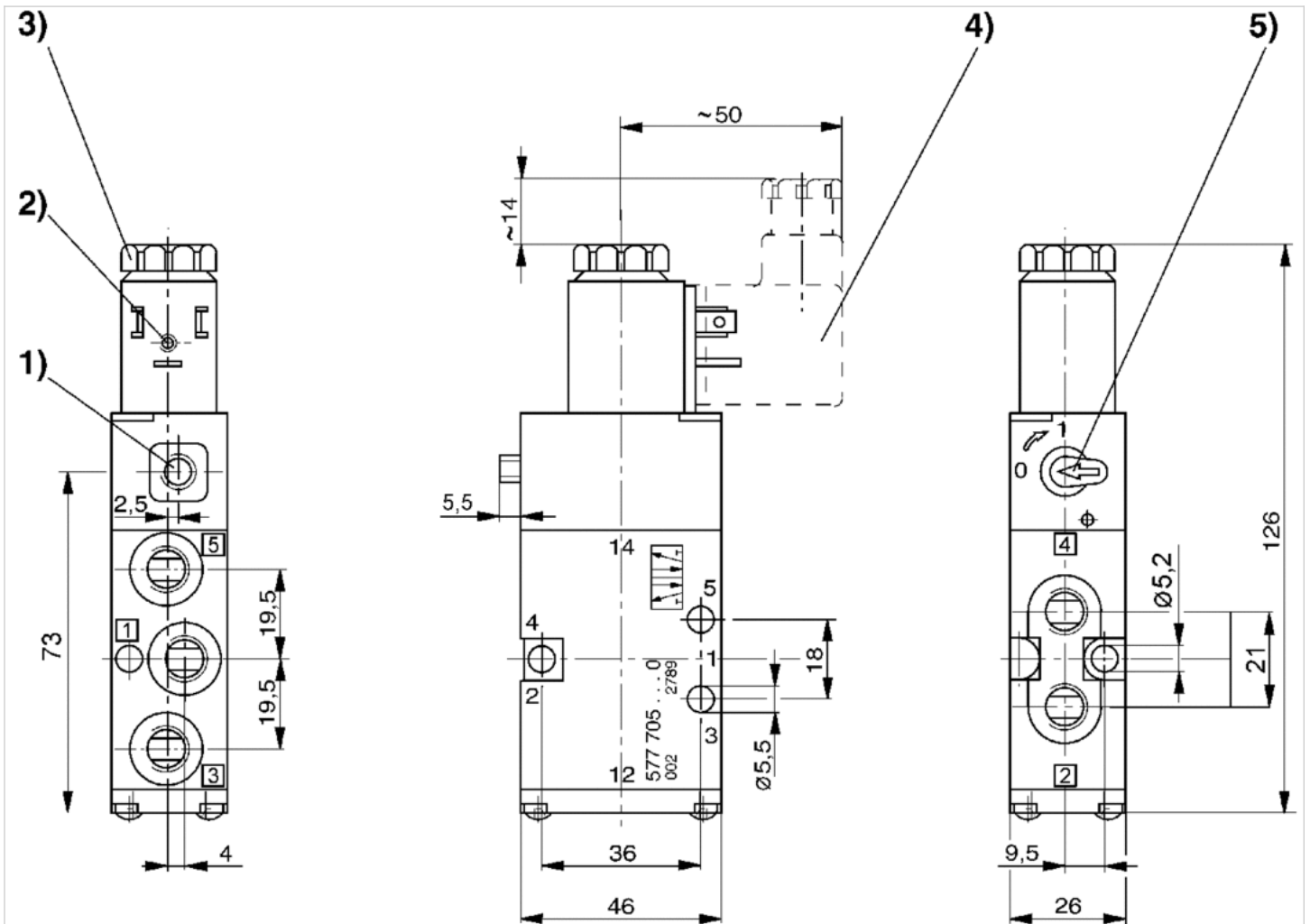

1) Only with separate pilot control G 1/8 2) Coil can be rotated at 90° intervals 3) After removal of cap M5 internal thread 4) Valve plug connector can be plugged at 180° intervals 5) Manual override















5/2-directional valve, Series CD04

- 5/2
- Qn = 900 l/min
- Pilot valve width : 26 mm
- Pipe connection
- Compressed air connection output : G 1/8
- Electrical connection : Plug, EN 175301-803, form B, 3-pin
- Manual override : with detent
- double solenoid
- Pilot : Internal External



Version	Spool valve, positive overlapping
Activation	Electrically
Sealing principle	Soft sealing
Working pressure min./max.	See table below
Control pressure min./max.	2 ... 10 bar
Ambient temperature min./max.	-15 ... 50 °C
Medium temperature min./max.	-15 ... 50 °C
Medium	Compressed air
Max. particle size	50 µm
Oil content of compressed air	0 ... 1 mg/m ³
Nominal flow Qn	900 l/min
Nominal flow 1 ► 2	900 l/min
Nominal flow 2 ► 3	900 l/min
Compressed air connection	according to ISO 228-1
Pilot control exhaust	with directional pilot air exhaust
Connector standard	EN 175301-803:2006
Protection class with connection	IP65
Compatibility index	14
Duty cycle	100 %
Mounting on manifold strip	P-strip
Weight	See table below

Technical data

Part No.		MO	Compressed air connection
			Input
R412008841			G 1/8
5777250220			G 1/8
5777255280			G 1/8
5777255302			G 1/8
5777260220			G 1/8
5777265280			G 1/8
5777265302			G 1/8

Part No.	Compressed air connection	Compressed air connection
	Output	Exhaust
R412008841	G 1/8	G 1/8
5777250220	G 1/8	G 1/8
5777255280	G 1/8	G 1/8
5777255302	G 1/8	G 1/8
5777260220	G 1/8	G 1/8
5777265280	G 1/8	G 1/8
5777265302	G 1/8	G 1/8

Part No.	Compressed air connection	Compressed air connection
	Pilot Input	Pilot Exhaust
R412008841	-	M5
5777250220	-	M5
5777255280	-	M5
5777255302	-	M5
5777260220	G 1/8	M5
5777265280	G 1/8	M5
5777265302	G 1/8	M5

Part No.	Operational voltage	Operational voltage	Operational voltage
	DC	AC 50 Hz	AC 60 Hz
R412008841	12 V	-	-
5777250220	24 V	-	-
5777255280	-	230 V	230 V
5777255302	-	-	-
5777260220	24 V	-	-
5777265280	-	230 V	230 V
5777265302	-	-	-

Part No.	Voltage tolerance	Voltage tolerance	Voltage tolerance	Power consumption
	DC	AC 50 Hz	AC 60 Hz	DC
R412008841	-10% / +10%	-	-	4.6 W
5777250220	-10% / +10%	-	-	4.8 W
5777255280	-	-20% / +10%	-10% / +20%	-
5777255302	-	-	-	-
5777260220	-10% / +10%	-	-	4.8 W
5777265280	-	-20% / +10%	-10% / +20%	-

Part No.	Voltage tolerance	Voltage tolerance	Voltage tolerance	Power consumption
	DC	AC 50 Hz	AC 60 Hz	DC
5777265302	-	-	-	-

Part No.	Holding power	Holding power	Switch-on power	Switch-on power	Pilot
	AC 50 Hz	AC 60 Hz	AC 50 Hz	AC 60 Hz	
R412008841	-	-	-	-	Internal
5777250220	-	-	-	-	Internal
5777255280	7.9 VA	6.4 VA	10.6 VA	8.9 VA	Internal
5777255302	-	-	-	-	Internal
5777260220	-	-	-	-	External
5777265280	7.9 VA	6.4 VA	10.6 VA	8.9 VA	External
5777265302	-	-	-	-	External

Part No.	Working pressure min./max.	Typ. switch-on time	Typ. switch-off time
R412008841	2 ... 10 bar	12 ms	12 ms
5777250220	2 ... 10 bar	12 ms	12 ms
5777255280	2 ... 10 bar	12 ms	12 ms
5777255302	2 ... 10 bar	-	-
5777260220	-0.95 ... 10 bar	12 ms	12 ms
5777265280	-0.95 ... 10 bar	12 ms	12 ms
5777265302	-0.95 ... 10 bar	-	-

Part No.	basic valve with electrical connector	Weight
R412008841	-	0.49 kg
5777250220	-	0.49 kg
5777255280	-	0.49 kg
5777255302	Basic valve without coil	0.36 kg
5777260220	-	0.5 kg
5777265280	-	0.5 kg
5777265302	Basic valve without coil	0.36 kg

Nominal flow Qn at 6 bar and $\Delta p = 1$ bar, MO = Manual override

Technical information

The min. control pressure must be adhered to, since otherwise faulty switching and valve failure may result!

The pressure dew point must be at least 15 °C under ambient and medium temperature and may not exceed 3 °C .

The oil content of compressed air must remain constant during the life cycle.

Use only the approved oils from AVENTICS. Further information can be found in the "Technical information" document (available in the MediaCentre).

Technical information

Material	
Housing	Die cast zinc Polyamide fiber-glass reinforced
Seals	Acrylonitrile butadiene rubber

Dimensions

Dimensions

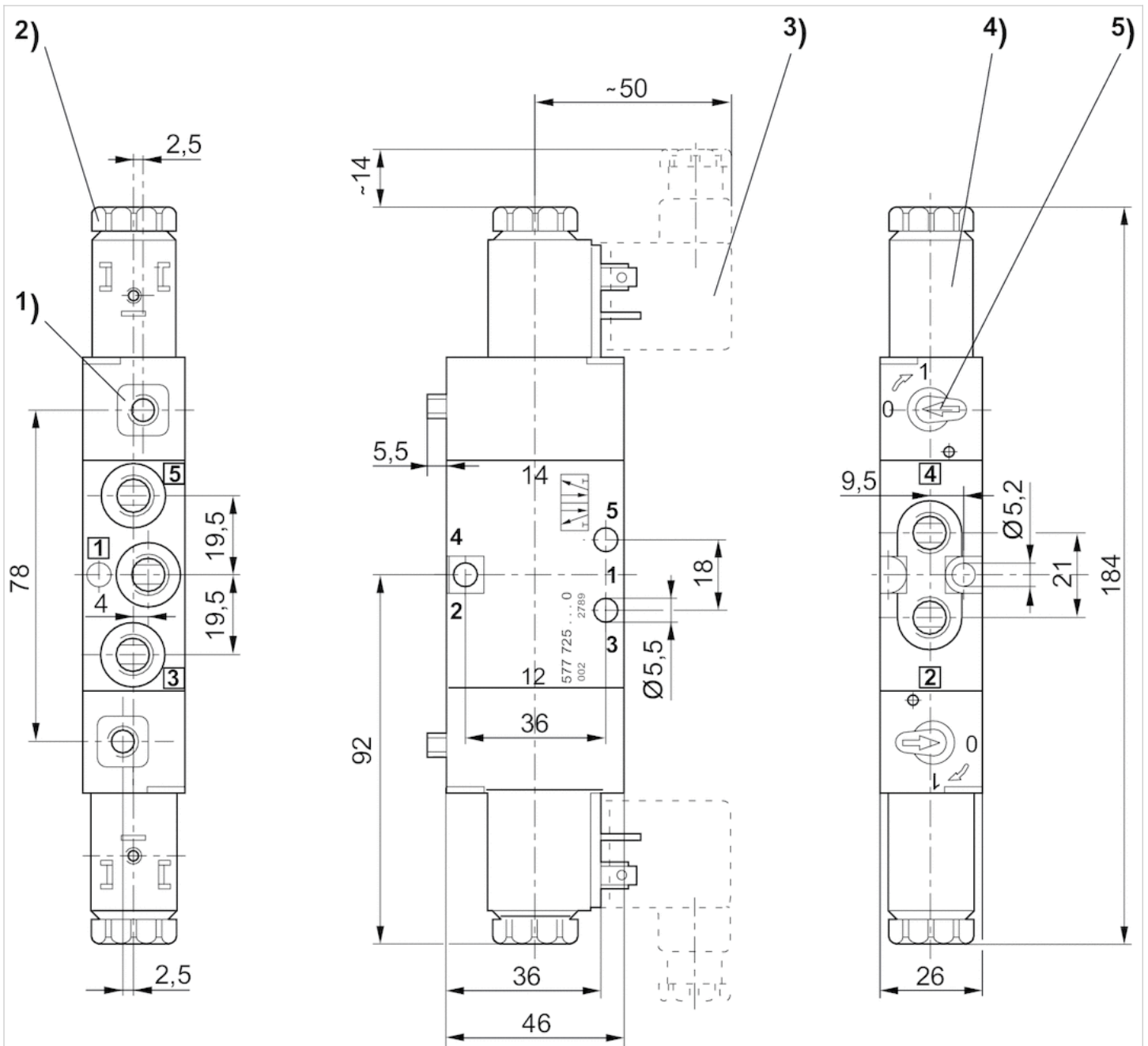

1) Only with separate pilot control G 1/82) After removal of cap M5 internal thread3) Valve plug connector can be plugged at 180° intervals4) Coil can be rotated at 90° intervals5) Manual override

5/3-directional valve, Series CD04

- 5/3
- Qn = 900 l/min
- Pilot valve width : 26 mm
- closed center exhausted center pressurized center
- Pipe connection
- Compressed air connection output : G 1/8
- Electrical connection : Plug, EN 175301-803, form B, 3-pin
- Manual override : with detent
- double solenoid
- With spring return
- Pilot : Internal



Version	Spool valve, positive overlapping
Activation	Electrically
Pilot	Internal
Sealing principle	Soft sealing
Working pressure min./max.	3.5 ... 10 bar
Control pressure min./max.	3.5 ... 10 bar
Ambient temperature min./max.	-15 ... 50 °C
Medium temperature min./max.	-15 ... 50 °C
Medium	Compressed air
Max. particle size	50 µm
Oil content of compressed air	0 ... 1 mg/m ³
Nominal flow Qn	900 l/min
Nominal flow 1 ► 2	900 l/min
Nominal flow 2 ► 3	900 l/min
Compressed air connection	according to ISO 228-1
Pilot control exhaust	with directional pilot air exhaust
Connector standard	EN 175301-803:2006
Protection class with connection	IP65
Compatibility index	14
Duty cycle	100 %
Mounting on manifold strip	P-strip
Weight	See table below

Technical data

Part No.		MO		Compressed air connection	
				Input	
5777420220		↓	closed center		G 1/8
5777425280		↓	closed center		G 1/8
5777425302		↓	closed center		G 1/8
5777410220		↓	exhausted center		G 1/8
5777415280		↓	exhausted center		G 1/8
5777415302		↓	exhausted center		G 1/8
5777400220		↓	pressurized center		G 1/8
5777405280		↓	pressurized center		G 1/8
5777405302		↓	pressurized center		G 1/8

Part No.	Compressed air connection	
	Output	Exhaust
5777420220	G 1/8	G 1/8
5777425280	G 1/8	G 1/8
5777425302	G 1/8	G 1/8
5777410220	G 1/8	G 1/8
5777415280	G 1/8	G 1/8
5777415302	G 1/8	G 1/8
5777400220	G 1/8	G 1/8
5777405280	G 1/8	G 1/8
5777405302	G 1/8	G 1/8

Part No.	Compressed air connection		Operational voltage	
	Pilot Exhaust		DC	AC 50 Hz
	5777420220	M5	24 V	-
5777425280	M5	-	230 V	
5777425302	M5	-	-	
5777410220	M5	24 V	-	
5777415280	M5	-	230 V	
5777415302	M5	-	-	
5777400220	M5	24 V	-	
5777405280	M5	-	230 V	
5777405302	M5	-	-	

Part No.	Operational voltage		Voltage tolerance		
	AC 60 Hz		DC	AC 50 Hz	AC 60 Hz
5777420220	-		-10% / +10%	-	-
5777425280	230 V		-	-20% / +10%	-10% / +20%
5777425302	-		-	-	-
5777410220	-		-10% / +10%	-	-
5777415280	230 V		-	-20% / +10%	-10% / +20%
5777415302	-		-	-	-
5777400220	-		-10% / +10%	-	-
5777405280	230 V		-	-20% / +10%	-10% / +20%
5777405302	-		-	-	-

Part No.	Power consumption	Holding power	Holding power	Switch-on power
	DC	AC 50 Hz	AC 60 Hz	AC 50 Hz
5777420220	4.8 W	-	-	-
5777425280	-	7.9 VA	6.4 VA	10.6 VA
5777425302	-	-	-	-
5777410220	4.8 W	-	-	-
5777415280	-	7.9 VA	6.4 VA	10.6 VA
5777415302	-	-	-	-
5777400220	4.8 W	-	-	-
5777405280	-	7.9 VA	6.4 VA	10.6 VA
5777405302	-	-	-	-

Part No.	Switch-on power	Typ. switch-on time	Typ. switch-off time
	AC 60 Hz		
5777420220	-	12 ms	27 ms
5777425280	8.9 VA	12 ms	27 ms
5777425302	-	-	-
5777410220	-	12 ms	27 ms
5777415280	8.9 VA	12 ms	27 ms
5777415302	-	-	-
5777400220	-	12 ms	27 ms
5777405280	8.9 VA	12 ms	27 ms
5777405302	-	-	-

Part No.	basic valve with electrical connector	Weight
5777420220	-	0.5 kg
5777425280	-	0.5 kg
5777425302	Basic valve without coil	0.39 kg
5777410220	-	0.5 kg
5777415280	-	0.5 kg
5777415302	Basic valve without coil	0.39 kg
5777400220	-	0.5 kg
5777405280	-	0.5 kg
5777405302	Basic valve without coil	0.39 kg

Nominal flow Qn at 6 bar and $\Delta p = 1$ bar, MO = Manual override

Technical information

The min. control pressure must be adhered to, since otherwise faulty switching and valve failure may result!

The pressure dew point must be at least 15 °C under ambient and medium temperature and may not exceed 3 °C .

The oil content of compressed air must remain constant during the life cycle.

Use only the approved oils from AVENTICS. Further information can be found in the "Technical information" document (available in the MediaCentre).

Technical information

Material	
Housing	Die cast zinc Polyamide fiber-glass reinforced
Seals	Acrylonitrile butadiene rubber

Dimensions

Dimensions

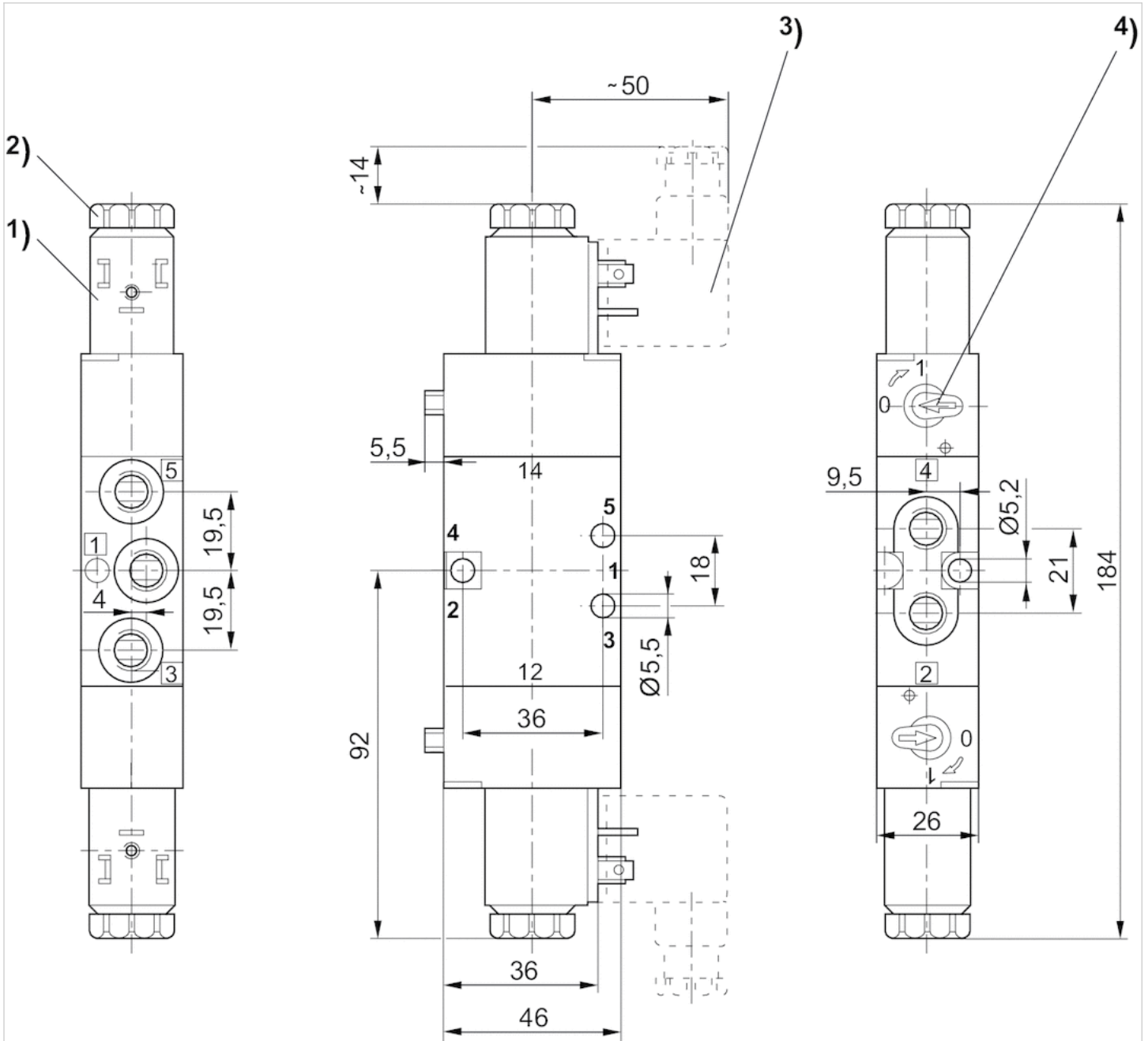

1) Coil can be rotated at 90° intervals 2) After removal of cap M5 internal thread 3) Valve plug connector can be plugged at 180° intervals 4) Manual override





3/2-directional valve, Series CD04

- 3/2
- Qn = 900 l/min
- Pilot valve width : 26 mm
- NC NO
- Pipe connection
- Compressed air connection output : M10x1
- Electrical connection : Plug, EN 175301-803, form B, 3-pin
- Manual override : with detent
- single solenoid
- With spring return
- Pilot : Internal



Version	Spool valve, positive overlapping
Activation	Electrically
Pilot	Internal
Sealing principle	Soft sealing
Working pressure min./max.	3 ... 10 bar
Control pressure min./max.	3 ... 10 bar
Ambient temperature min./max.	-15 ... 50 °C
Medium temperature min./max.	-15 ... 50 °C
Medium	Compressed air
Max. particle size	50 µm
Oil content of compressed air	0 ... 1 mg/m ³
Nominal flow Qn	900 l/min
Nominal flow 1 ► 2	900 l/min
Nominal flow 2 ► 3	900 l/min
Pilot control exhaust	with directional pilot air exhaust
Connector standard	EN 175301-803:2006
Protection class with connection	IP65
Compatibility index	14
Duty cycle	100 %
Weight	See table below

Technical data

Part No.		MO		Compressed air connection	
				Input	
5772500220			NC NO	M10x1	
5772505302			NC NO	M10x1	

Part No.	Compressed air connection		Compressed air connection	
	Output		Exhaust	
5772500220	M10x1		M10x1	
5772505302	M10x1		M10x1	

Part No.	Compressed air connection		Operational voltage	Voltage tolerance
	Pilot Exhaust			
5772500220	M5		24 V	-10% / +10%
5772505302	M5		-	-

Part No.	Power consumption		Typ. switch-on time	Typ. switch-off time
	DC			
5772500220	4.8 W		13 ms	27 ms
5772505302	-		-	-

Part No.	basic valve with electrical connector	Weight
5772500220	-	0.3 kg
5772505302	Basic valve without coil	0.25 kg

Nominal flow Q_n at 6 bar and $\Delta p = 1$ bar, MO = Manual override

Technical information

The min. control pressure must be adhered to, since otherwise faulty switching and valve failure may result!

The pressure dew point must be at least 15 °C under ambient and medium temperature and may not exceed 3 °C .

The oil content of compressed air must remain constant during the life cycle.

Use only the approved oils from AVENTICS. Further information can be found in the "Technical information" document (available in the MediaCentre).

option valve: The input and output compressed air connections can be exchanged.

The valve can thereby be used in the NC or NO operating mode.

Technical information

Material	
Housing	Die cast zinc Polyamide fiber-glass reinforced
Seals	Acrylonitrile butadiene rubber

Dimensions

Dimensions

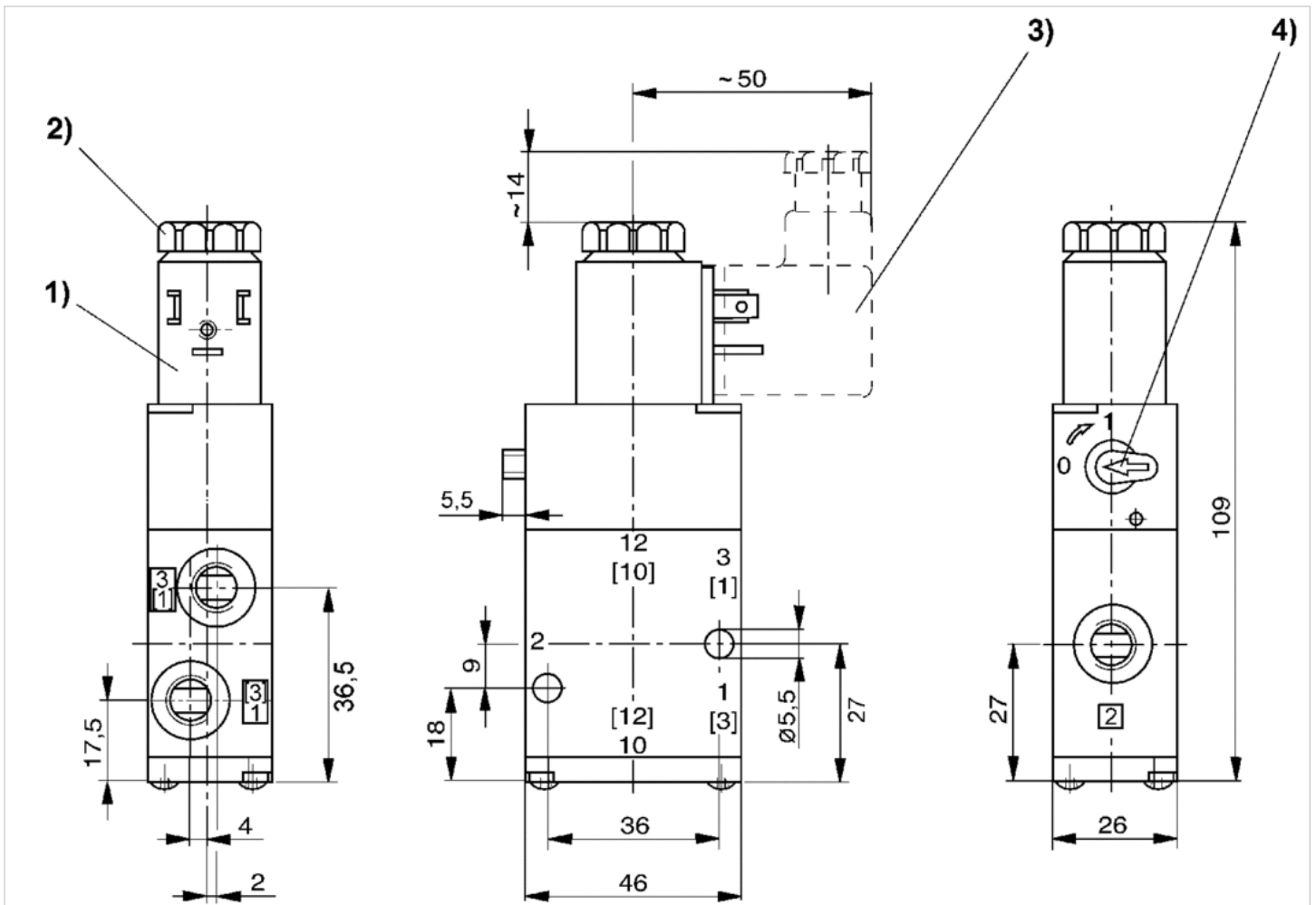

1) Coil can be rotated at 90° intervals 2) After removal of cap M5 internal thread 3) Valve plug connector can be plugged at 180° intervals 4) Manual override







5/2-directional valve, Series CD04

- 5/2
- $Q_n = 900$ l/min
- Pilot valve width : 26 mm
- Pipe connection
- Compressed air connection output : M10x1
- Electrical connection : Plug, EN 175301-803, form B, 3-pin
- Manual override : with detent
- double solenoid
- Pilot : Internal



Version	Spool valve, positive overlapping
Activation	Electrically
Pilot	Internal
Sealing principle	Soft sealing
Working pressure min./max.	2 ... 10 bar
Control pressure min./max.	2 ... 10 bar
Ambient temperature min./max.	-15 ... 50 °C
Medium temperature min./max.	-15 ... 50 °C
Medium	Compressed air
Max. particle size	50 µm
Oil content of compressed air	0 ... 1 mg/m ³
Nominal flow Q_n	900 l/min
Nominal flow 1 ► 2	900 l/min
Nominal flow 2 ► 3	900 l/min
Pilot control exhaust	with directional pilot air exhaust
Connector standard	EN 175301-803:2006
Protection class with connection	IP65
Compatibility index	14
Duty cycle	100 %
Mounting on manifold strip	P-strip
Weight	See table below

Technical data

Part No.		MO	Compressed air connection	
			Input	Output
5777200220			M10x1	M10x1
5777205280			M10x1	M10x1
5777205302			M10x1	M10x1

Part No.	Compressed air connection	
	Exhaust	Pilot Exhaust
5777200220	M10x1	M5
5777205280	M10x1	M5
5777205302	M10x1	M5

Part No.	Operational voltage		Operational voltage
	DC	AC 50 Hz	AC 60 Hz
5777200220	24 V	-	-
5777205280	-	230 V	230 V
5777205302	-	-	-

Part No.	Voltage tolerance	Voltage tolerance	Voltage tolerance	Power consumption
	DC	AC 50 Hz	AC 60 Hz	DC
5777200220	-10% / +10%	-	-	4.8 W
5777205280	-	-20% / +10%	-10% / +20%	-
5777205302	-	-	-	-

Part No.	Holding power		Switch-on power	
	AC 50 Hz	AC 60 Hz	AC 50 Hz	AC 60 Hz
5777200220	-	-	-	-
5777205280	7.9 VA	6.4 VA	10.6 VA	8.9 VA
5777205302	-	-	-	-

Part No.	Typ. switch-on time	Typ. switch-off time	basic valve with electrical connector	Weight
5777200220	12 ms	12 ms	-	0.49 kg
5777205280	12 ms	12 ms	-	0.49 kg
5777205302	-	-	Basic valve without coil	0.39 kg

Nominal flow Q_n at 6 bar and $\Delta p = 1$ bar, MO = Manual override

Technical information

The min. control pressure must be adhered to, since otherwise faulty switching and valve failure may result!

The pressure dew point must be at least 15 °C under ambient and medium temperature and may not exceed 3 °C .

The oil content of compressed air must remain constant during the life cycle.

Use only the approved oils from AVENTICS. Further information can be found in the "Technical information" document (available in the MediaCentre).

Technical information

Material

Housing	Die cast zinc Polyamide fiber-glass reinforced
Seals	Acrylonitrile butadiene rubber

Dimensions

Dimensions

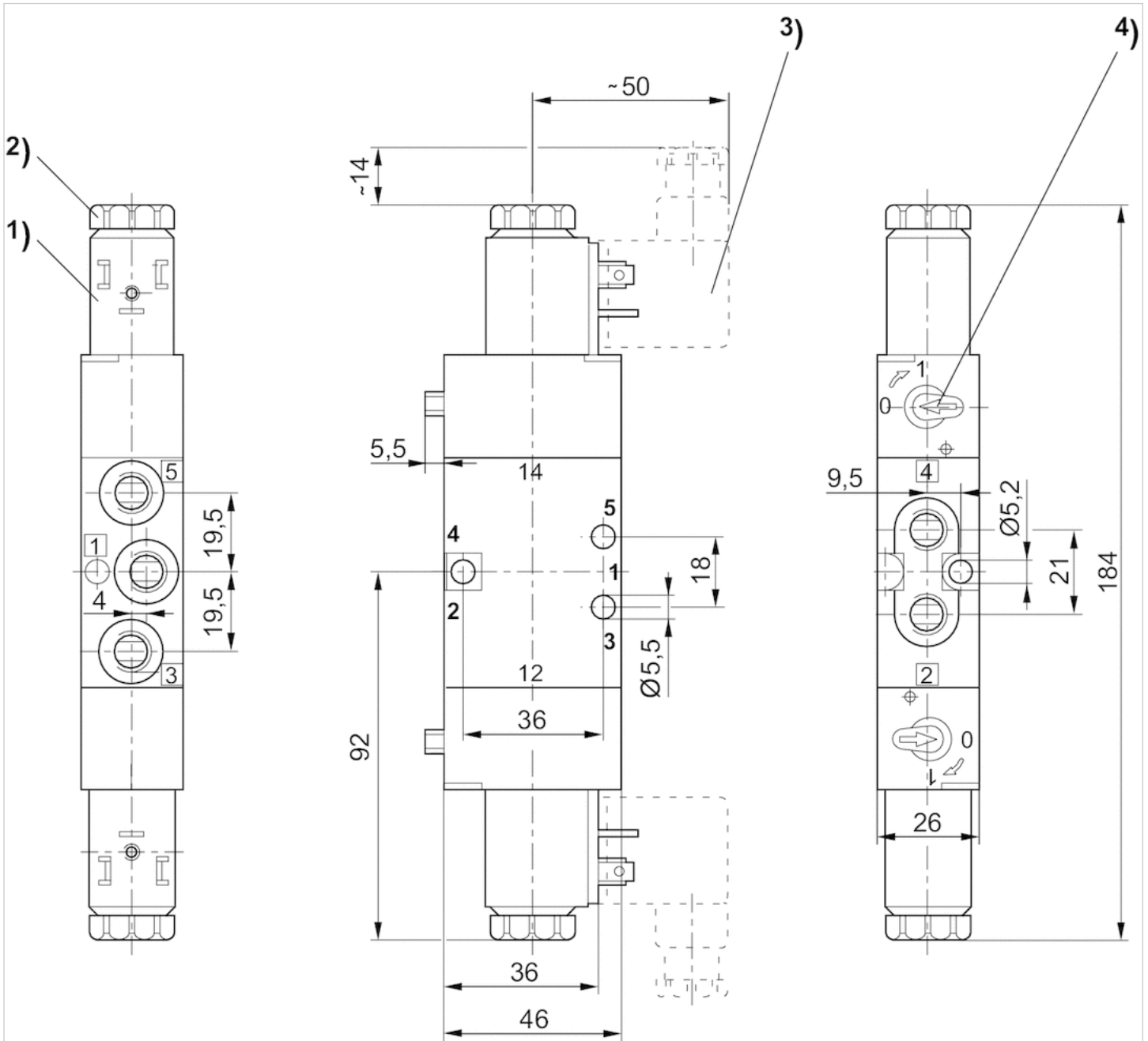

1) Coil can be rotated at 90° intervals 2) After removal of cap M5 internal thread 3) Valve plug connector can be plugged at 180° intervals 4) Manual override







5/2-directional valve, Series CD04

- 5/2
- $Q_n = 900$ l/min
- Pilot valve width : 26 mm
- Pipe connection
- Compressed air connection output : M10x1
- Electrical connection : Plug, EN 175301-803, form B, 3-pin
- Manual override : with detent
- single solenoid
- Pilot : Internal



Version	Spool valve, positive overlapping
Activation	Electrically
Pilot	Internal
Sealing principle	Soft sealing
Working pressure min./max.	3 ... 10 bar
Control pressure min./max.	3 ... 10 bar
Ambient temperature min./max.	-15 ... 50 °C
Medium temperature min./max.	-15 ... 50 °C
Medium	Compressed air
Max. particle size	50 µm
Oil content of compressed air	0 ... 1 mg/m ³
Nominal flow Q_n	900 l/min
Nominal flow 1 ► 2	900 l/min
Nominal flow 2 ► 3	900 l/min
Pilot control exhaust	with directional pilot air exhaust
Connector standard	EN 175301-803:2006
Protection class with connection	IP65
Compatibility index	14
Duty cycle	100 %
Mounting on manifold strip	P-strip
Weight	See table below

Technical data

Part No.		MO	Compressed air connection	
			Input	
5777000220			M10x1	
5777005280			M10x1	
5777005302			M10x1	

Part No.	Compressed air connection	
	Output	Exhaust
5777000220	M10x1	M10x1
5777005280	M10x1	M10x1
5777005302	M10x1	M10x1

Part No.	Compressed air connection		Operational voltage	
	Pilot Exhaust		DC	AC 50 Hz
5777000220	M5		24 V	-
5777005280	M5		-	230 V
5777005302	M5		-	-

Part No.	Operational voltage	Voltage tolerance		
		DC	AC 50 Hz	AC 60 Hz
5777000220	-	-10% / +10%	-	-
5777005280	230 V	-	-20% / +10%	-10% / +20%
5777005302	-	-	-	-

Part No.	Power consumption		Holding power		Switch-on power
	DC	AC 50 Hz	AC 60 Hz	AC 50 Hz	
5777000220	4.8 W	-	-	-	
5777005280	-	7.9 VA	6.4 VA	10.6 VA	
5777005302	-	-	-	-	

Part No.	Switch-on power		Typ. switch-on time	Typ. switch-off time
	AC 60 Hz			
5777000220	-		12 ms	21 ms
5777005280	8.9 VA		12 ms	21 ms
5777005302	-		-	-

Part No.	basic valve with electrical connector	Weight
5777000220	-	0.39 kg
5777005280	-	0.39 kg
5777005302	Basic valve without coil	0.36 kg

Nominal flow Q_n at 6 bar and Δp = 1 bar, MO = Manual override

Technical information

The min. control pressure must be adhered to, since otherwise faulty switching and valve failure may result!
 The pressure dew point must be at least 15 °C under ambient and medium temperature and may not exceed 3 °C .
 The oil content of compressed air must remain constant during the life cycle.
 Use only the approved oils from AVENTICS. Further information can be found in the “Technical information” document (available in the MediaCentre).

Technical information

Material	
Housing	Die cast zinc Polyamide fiber-glass reinforced
Seals	Acrylonitrile butadiene rubber

Dimensions

Dimensions

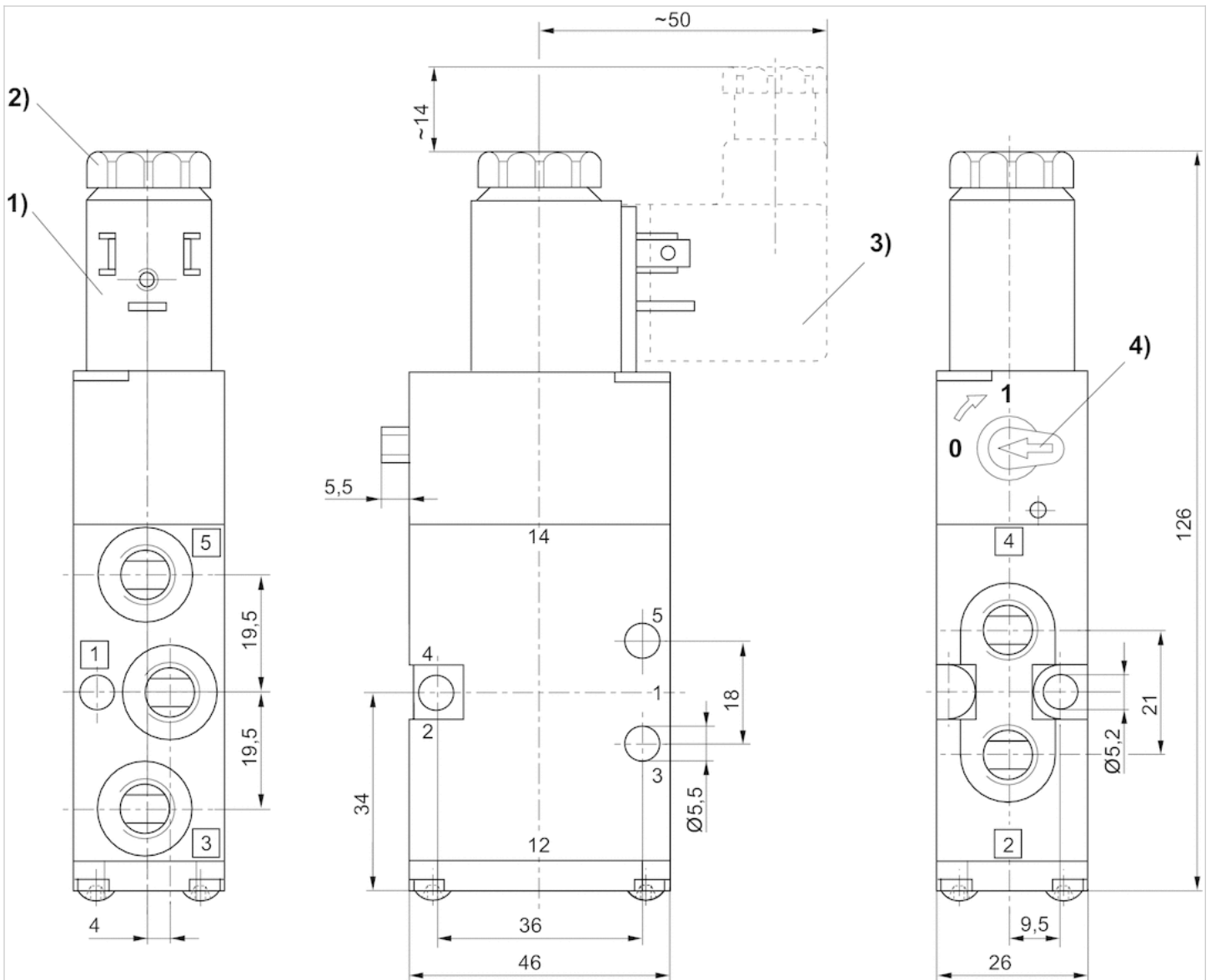

1) Coil can be rotated at 90° intervals 2) After removal of cap M5 internal thread 3) Valve plug connector can be plugged at 180° intervals 4) Manual override

3/2-directional valve, Series CD04

- Qn = 900 l/min
- Compressed air connection output G 1/8
- Single air pilot
- Pipe connection



Version	Spool valve, positive overlapping
Activation	pneumatically
Sealing principle	Soft sealing
Compressed air connection	according to ISO 228-1
Flow rate value Qn	900 l/min
Working pressure min./max.	-0.95 ... 10 bar
Control pressure min./max.	3.5 ... 10 bar
Ambient temperature min./max.	-15 ... 65 °C
Medium temperature min./max.	-15 ... 65 °C
Medium	Compressed air
Max. particle size	50 µm
Oil content of compressed air	0 ... 1 mg/m ³
Weight	0.29 kg

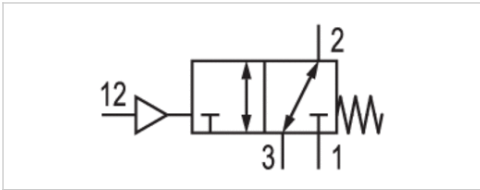

Technical data

Part No.		Compressed air connection	
		Input	Output
5710200100	NC/NO	G 1/8	G 1/8

Part No.	Compressed air connection	
	Exhaust	Pilot control exhaust
5710200100	G 1/8	G 1/8

Nominal flow Qn at 6 bar and $\Delta p = 1$ bar

Technical information

The min. control pressure must be adhered to, since otherwise faulty switching and valve failure may result!
 The pressure dew point must be at least 15 °C under ambient and medium temperature and may not exceed 3 °C .
 The oil content of compressed air must remain constant during the life cycle.
 Use only the approved oils from AVENTICS. Further information can be found in the "Technical information" document (available in the MediaCentre).

Technical information

Material	
Housing	Die cast zinc Polyamide fiber-glass reinforced
Seals	Acrylonitrile butadiene rubber

Dimensions

Dimensions

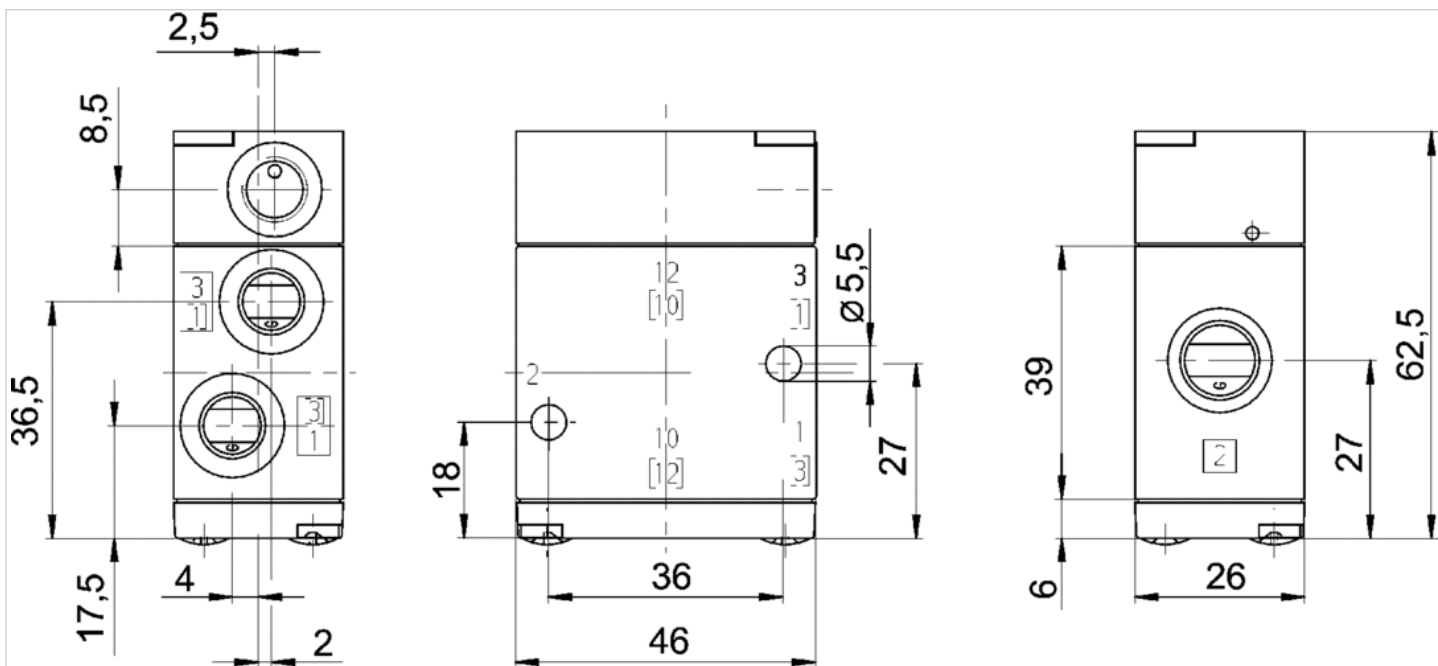

5/2-directional valve, Series CD04

- Qn = 900 l/min
- Compressed air connection output G 1/8
- Single air pilot
- Single air pilot
- Pipe connection



Version	Spool valve, positive overlapping
Activation	pneumatically
Sealing principle	Soft sealing
Compressed air connection	according to ISO 228-1
Flow rate value Qn	900 l/min
Working pressure min./max.	-0.95 ... 10 bar
Control pressure min./max.	3.5 ... 10 bar
Ambient temperature min./max.	-15 ... 65 °C
Medium temperature min./max.	-15 ... 65 °C
Medium	Compressed air
Max. particle size	50 µm
Oil content of compressed air	0 ... 1 mg/m ³
Mounting on manifold strip	P-strip
Weight	0.31 kg

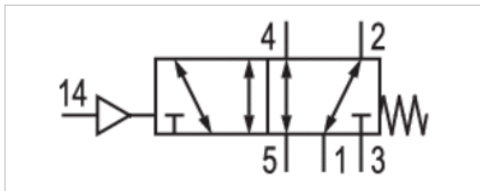

Technical data

Part No.	Compressed air connection	
	Input	Output
5710300100	G 1/8	G 1/8

Part No.	Compressed air connection	
	Exhaust	Pilot control exhaust
5710300100	G 1/8	G 1/8

Nominal flow Qn at 6 bar and $\Delta p = 1$ bar

Technical information

The min. control pressure must be adhered to, since otherwise faulty switching and valve failure may result!

The pressure dew point must be at least 15 °C under ambient and medium temperature and may not exceed 3 °C .

The oil content of compressed air must remain constant during the life cycle.

Use only the approved oils from AVENTICS. Further information can be found in the "Technical information" document (available in the MediaCentre).

Technical information

Material

Housing	Die cast zinc Polyamide fiber-glass reinforced
Seals	Acrylonitrile butadiene rubber

Dimensions

Dimensions

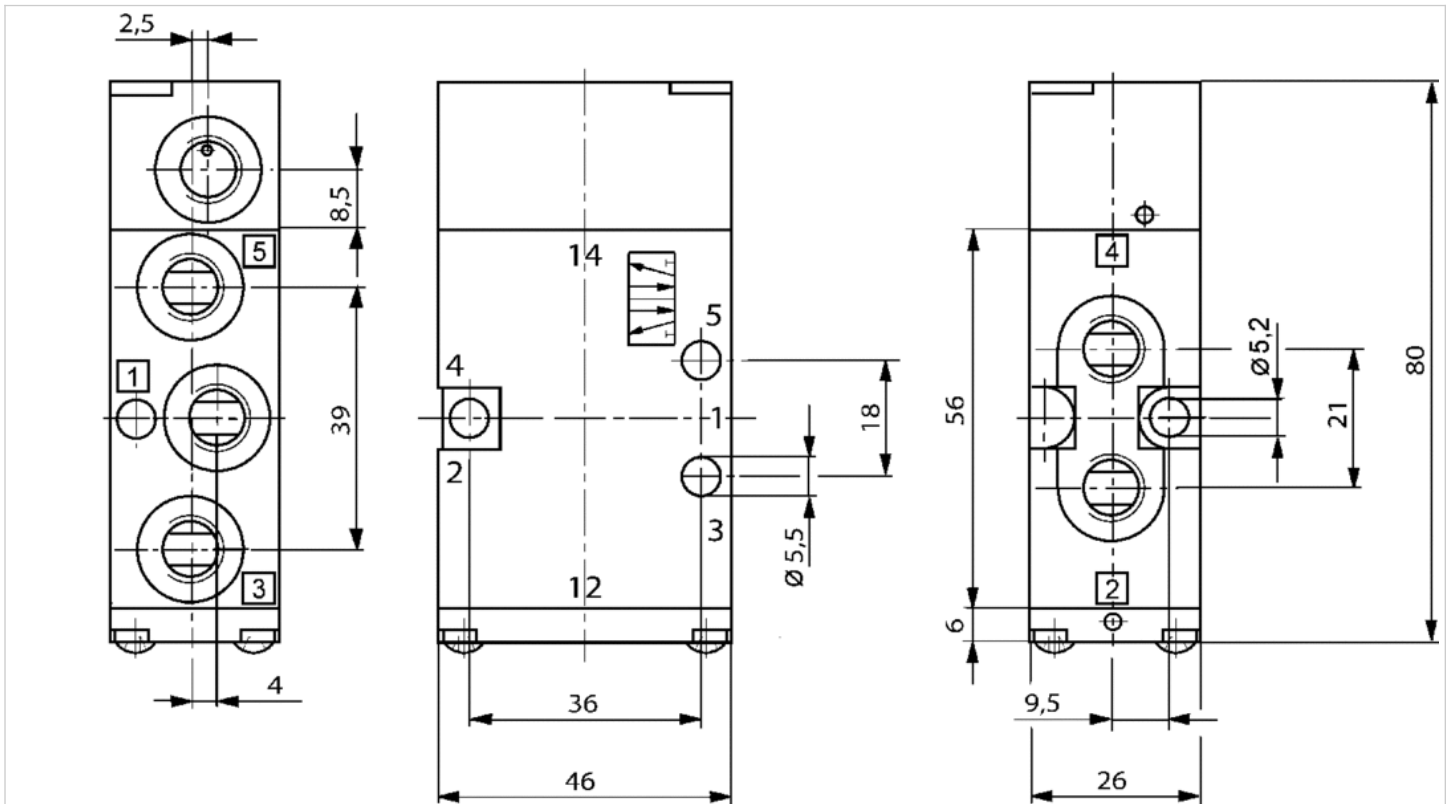

5/2-directional valve, Series CD04

- Qn = 900 l/min
- Compressed air connection output G 1/8
- double air pilot
- Pipe connection

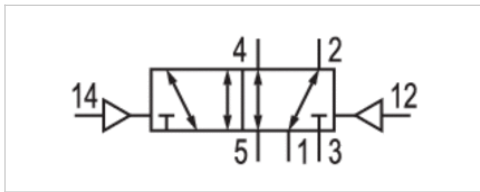

Version	Spool valve, positive overlapping
Activation	pneumatically
Sealing principle	Soft sealing
Compressed air connection	according to ISO 228-1
Flow rate value Qn	900 l/min
Working pressure min./max.	-0.95 ... 10 bar
Control pressure min./max.	2 ... 10 bar
Ambient temperature min./max.	-15 ... 65 °C
Medium temperature min./max.	-15 ... 65 °C
Medium	Compressed air
Max. particle size	50 µm
Oil content of compressed air	0 ... 1 mg/m ³
Mounting on manifold strip	P-strip
Weight	0.3 kg

Technical data

Part No.	Compressed air connection	
	Input	Output
5710301100	G 1/8	G 1/8

Part No.	Compressed air connection	
	Exhaust	Pilot control exhaust
5710301100	G 1/8	G 1/8

Nominal flow Qn at 6 bar and $\Delta p = 1$ bar

Technical information

The min. control pressure must be adhered to, since otherwise faulty switching and valve failure may result!
 The pressure dew point must be at least 15 °C under ambient and medium temperature and may not exceed 3 °C .
 The oil content of compressed air must remain constant during the life cycle.
 Use only the approved oils from AVENTICS. Further information can be found in the "Technical information" document (available in the MediaCentre).

Technical information

Material	
Housing	Die cast zinc Polyamide fiber-glass reinforced
Seals	Acrylonitrile butadiene rubber

Dimensions

Dimensions

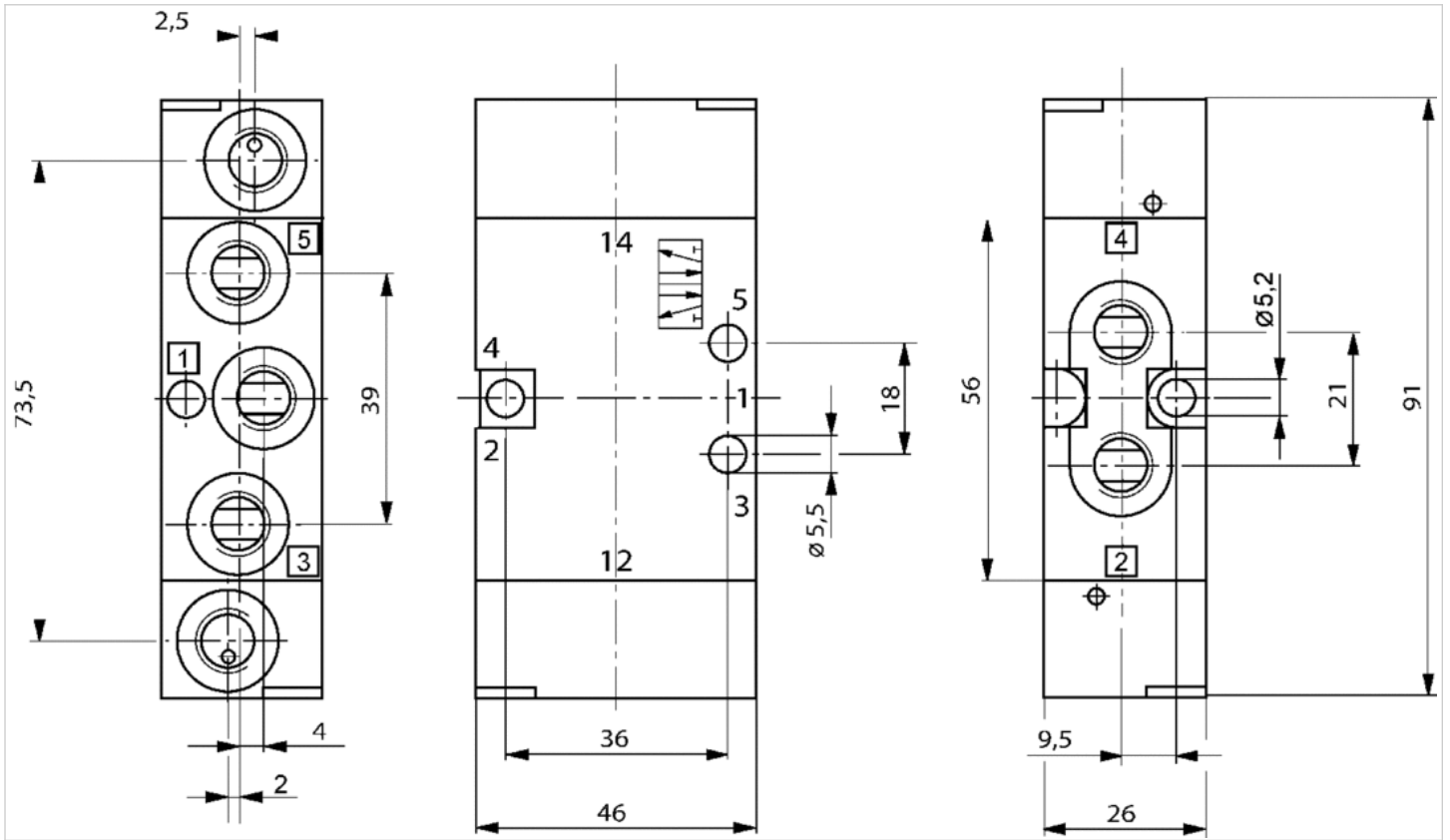

3/2-directional valve, Series CD04

- Qn = 900 l/min
- Compressed air connection output M10x1
- Single air pilot
- Pipe connection



Version	Spool valve, positive overlapping
Activation	pneumatically
Sealing principle	Soft sealing
Flow rate value Qn	900 l/min
Working pressure min./max.	-0.95 ... 10 bar
Control pressure min./max.	3.5 ... 10 bar
Ambient temperature min./max.	-15 ... 65 °C
Medium temperature min./max.	-15 ... 65 °C
Medium	Compressed air
Max. particle size	50 µm
Oil content of compressed air	0 ... 1 mg/m ³
Weight	0.29 kg

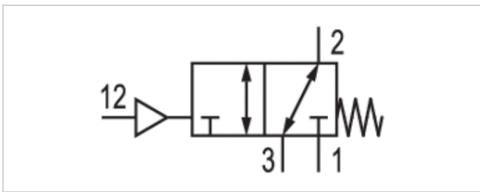

Technical data

Part No.		Compressed air connection	
		Input	Output
R412005941	NC/NO	M10x1	M10x1

Part No.	Compressed air connection	
	Exhaust	Pilot control exhaust
R412005941	M10x1	M10x1

Nominal flow Qn at 6 bar and $\Delta p = 1$ bar

Technical information

The min. control pressure must be adhered to, since otherwise faulty switching and valve failure may result!
 The pressure dew point must be at least 15 °C under ambient and medium temperature and may not exceed 3 °C .
 The oil content of compressed air must remain constant during the life cycle.
 Use only the approved oils from AVENTICS. Further information can be found in the "Technical information" document (available in the MediaCentre).

Technical information

Material	
Housing	Die cast zinc Polyamide fiber-glass reinforced
Seals	Acrylonitrile butadiene rubber

Dimensions

Dimensions

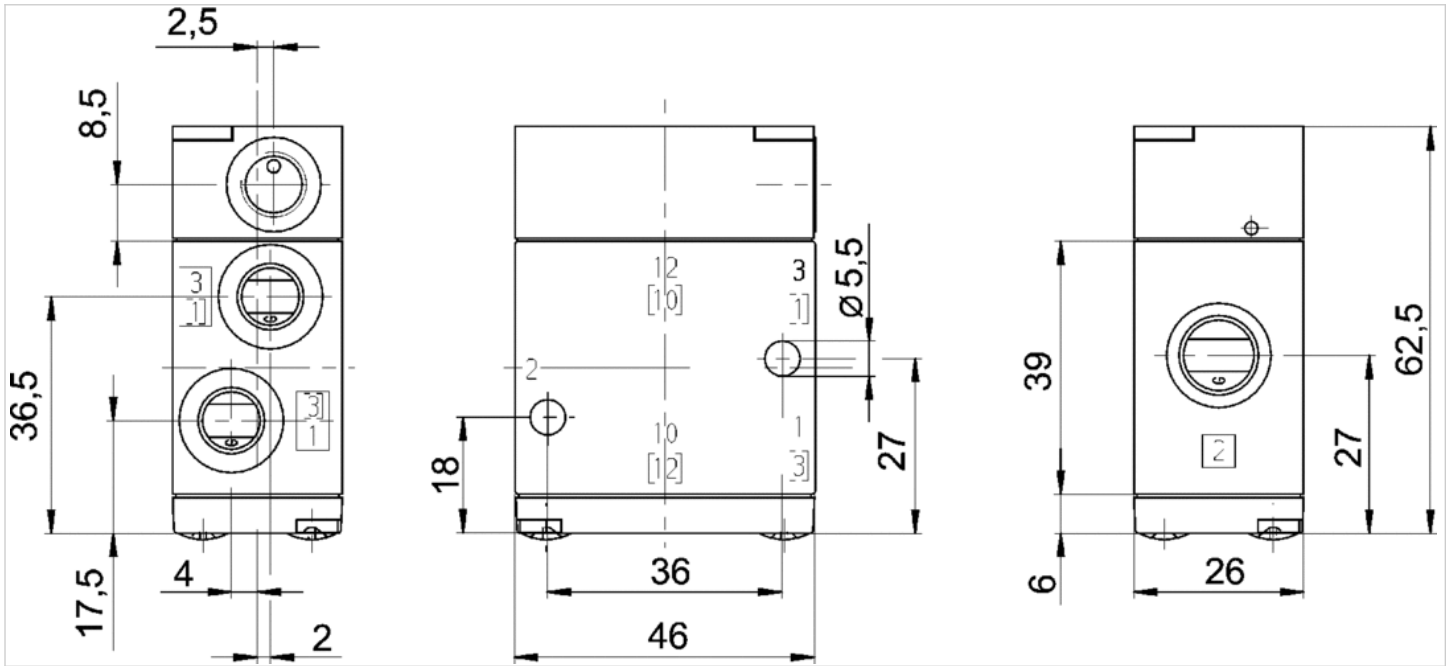

5/2-directional valve, Series CD04

- Qn = 900 l/min
- Compressed air connection output M10x1
- Single air pilot
- Pipe connection



Version	Spool valve, positive overlapping
Activation	pneumatically
Sealing principle	Soft sealing
Flow rate value Qn	900 l/min
Working pressure min./max.	-0.95 ... 10 bar
Control pressure min./max.	3.5 ... 10 bar
Ambient temperature min./max.	-15 ... 65 °C
Medium temperature min./max.	-15 ... 65 °C
Medium	Compressed air
Max. particle size	50 µm
Oil content of compressed air	0 ... 1 mg/m ³
Mounting on manifold strip	P-strip
Weight	0.31 kg

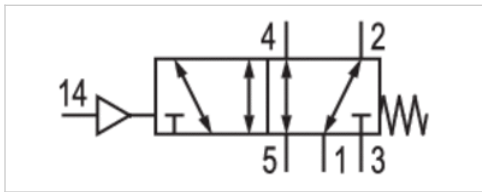

Technical data

Part No.	Compressed air connection	
	Input	Output
R412012543	M10x1	M10x1

Part No.	Compressed air connection	
	Exhaust	Pilot control exhaust
R412012543	M10x1	M10x1

Nominal flow Qn at 6 bar and Δp = 1 bar

Technical information

The min. control pressure must be adhered to, since otherwise faulty switching and valve failure may result!
 The pressure dew point must be at least 15 °C under ambient and medium temperature and may not exceed 3 °C .
 The oil content of compressed air must remain constant during the life cycle.
 Use only the approved oils from AVENTICS. Further information can be found in the “Technical information” document (available in the MediaCentre).

Technical information

Material	
Housing	Die cast zinc Polyamide fiber-glass reinforced
Seals	Acrylonitrile butadiene rubber

Dimensions

Dimensions

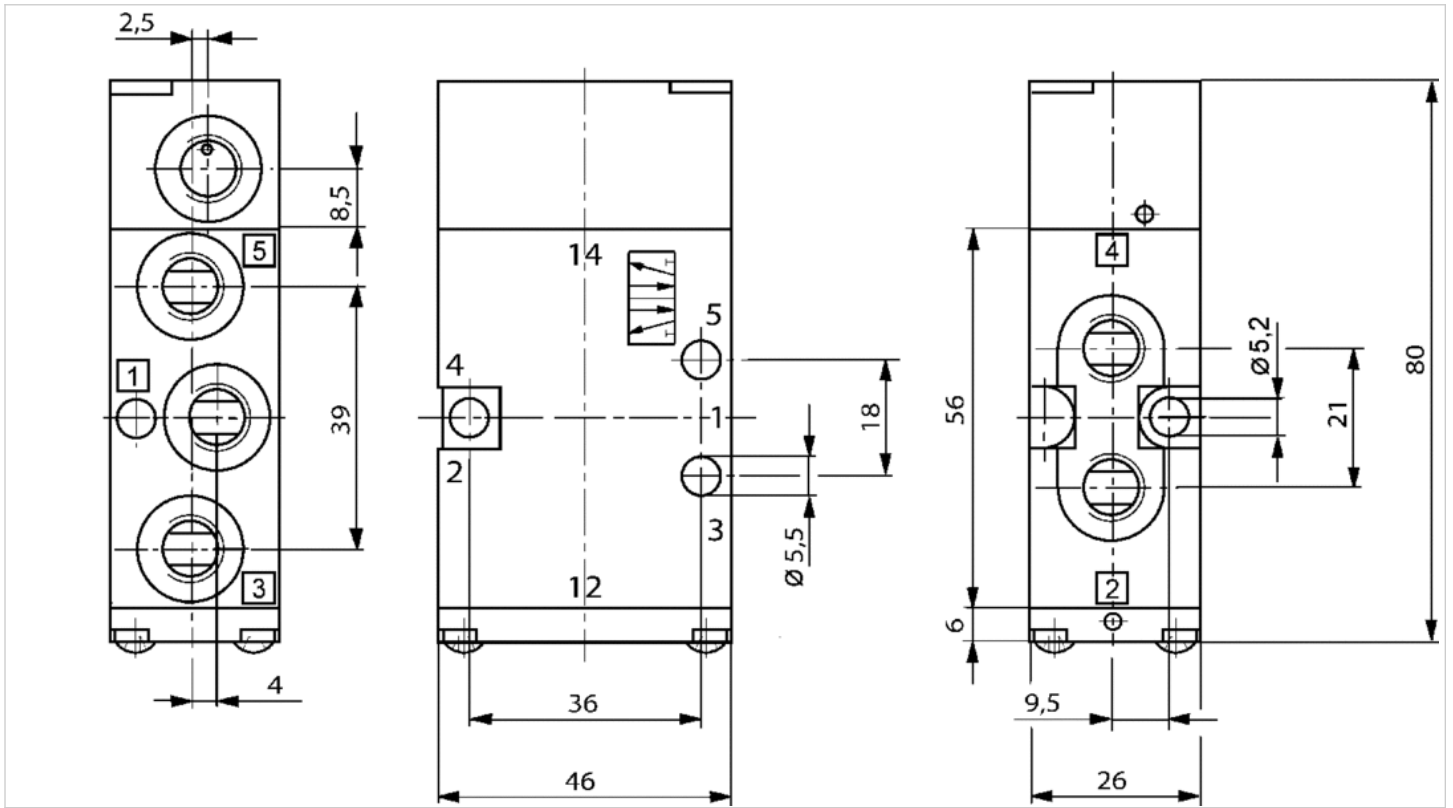

5/2-directional valve, Series CD04

- $Q_n = 900$ l/min
- Compressed air connection output M10x1
- double air pilot
- Pipe connection



Version	Spool valve, positive overlapping
Activation	pneumatically
Sealing principle	Soft sealing
Flow rate value Q_n	900 l/min
Working pressure min./max.	-0.95 ... 10 bar
Control pressure min./max.	2 ... 10 bar
Ambient temperature min./max.	-15 ... 65 °C
Medium temperature min./max.	-15 ... 65 °C
Medium	Compressed air
Max. particle size	50 μ m
Oil content of compressed air	0 ... 1 mg/m ³
Mounting on manifold strip	P-strip
Weight	0.3 kg

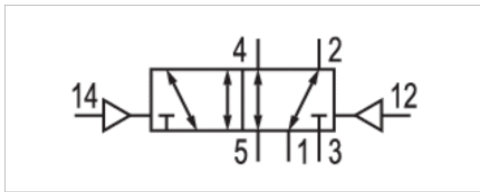

Technical data

Part No.	Compressed air connection	
	Input	Output
R412008116	M10x1	M10x1

Part No.	Compressed air connection	
	Exhaust	Pilot control exhaust
R412008116	M10x1	M10x1

Nominal flow Q_n at 6 bar and $\Delta p = 1$ bar

Technical information

The min. control pressure must be adhered to, since otherwise faulty switching and valve failure may result!
 The pressure dew point must be at least 15 °C under ambient and medium temperature and may not exceed 3 °C .
 The oil content of compressed air must remain constant during the life cycle.
 Use only the approved oils from AVENTICS. Further information can be found in the "Technical information" document (available in the MediaCentre).

Technical information

Material	
Housing	Die cast zinc Polyamide fiber-glass reinforced
Seals	Acrylonitrile butadiene rubber

Dimensions

Dimensions

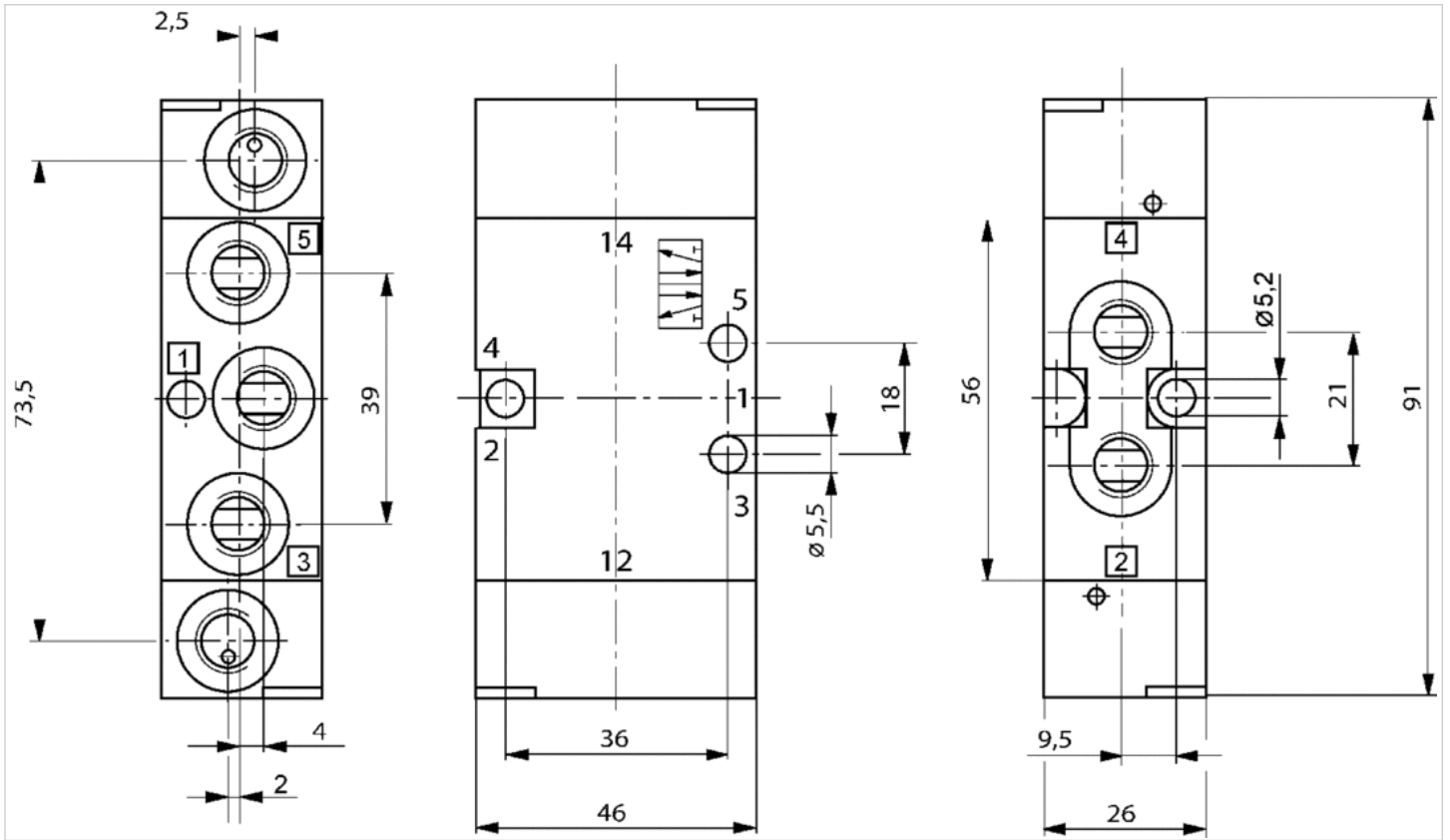







3/2-directional valve, Series CD04

- Qn = 900 l/min
- Compressed air connection output G 1/8
- single solenoid
- Pipe connection



Version	Spool valve, positive overlapping
Activation	Mechanical
Switching principle	3/2
Sealing principle	Soft sealing
Nominal flow Qn	900 l/min
Working pressure min./max.	-0.95 ... 10 bar
Ambient temperature min./max.	-20 ... 65 °C
Medium temperature min./max.	-20 ... 65 °C
Medium	Compressed air
Max. particle size	50 µm
Oil content of compressed air	0 ... 1 mg/m ³
Weight	See table below

Technical data

Part No.		Actuating element	Version	Compressed air connection type
5634000100		Plunger	NC/NO	Internal thread
5634010100		Roller	NC/NO	Internal thread
5634030100		Hand lever, with detent, without detent	NC/NO	Internal thread
5634040100		Hand lever	NC/NO	Internal thread
5634050100		Rotary lever, with detent	NC/NO	Internal thread
5634060100		Button	NC/NO	Internal thread

Part No.	Compressed air connection Input	Compressed air connection Output	Compressed air connection Exhaust
5634000100	G 1/8	G 1/8	G 1/8
5634010100	G 1/8	G 1/8	G 1/8
5634030100	G 1/8	G 1/8	G 1/8
5634040100	G 1/8	G 1/8	G 1/8
5634050100	G 1/8	G 1/8	G 1/8
5634060100	G 1/8	G 1/8	G 1/8

Part No.	Operating force	Material actuating control	Weight	Fig.
	min.			
5634000100	60 N	Stainless steel	0.23 kg	Fig. 1
5634010100	30 N	Polyoxymethylene	0.29 kg	Fig. 2
5634030100	15 N	Polyoxymethylene	0.32 kg	Fig. 3
5634040100	15 N	-	0.29 kg	Fig. 4
5634050100	15 N	Plastic Stainless steel	0.5 kg	Fig. 5
5634060100	60 N	Polyoxymethylene	0.25 kg	Fig. 6

Nominal flow Qn at 6 bar and $\Delta p = 1$ bar

Technical information

option valve: The input and output compressed air connections can be exchanged.
The valve can thereby be used in the NC or NO operating mode.

Technical information

Material

Housing	Die cast zinc Polyamide fiber-glass reinforced
Seals	Acrylonitrile butadiene rubber
Actuating element	Stainless steel Polyoxymethylene Plastic, Stainless steel

Dimensions

Dimensions, Fig. 1

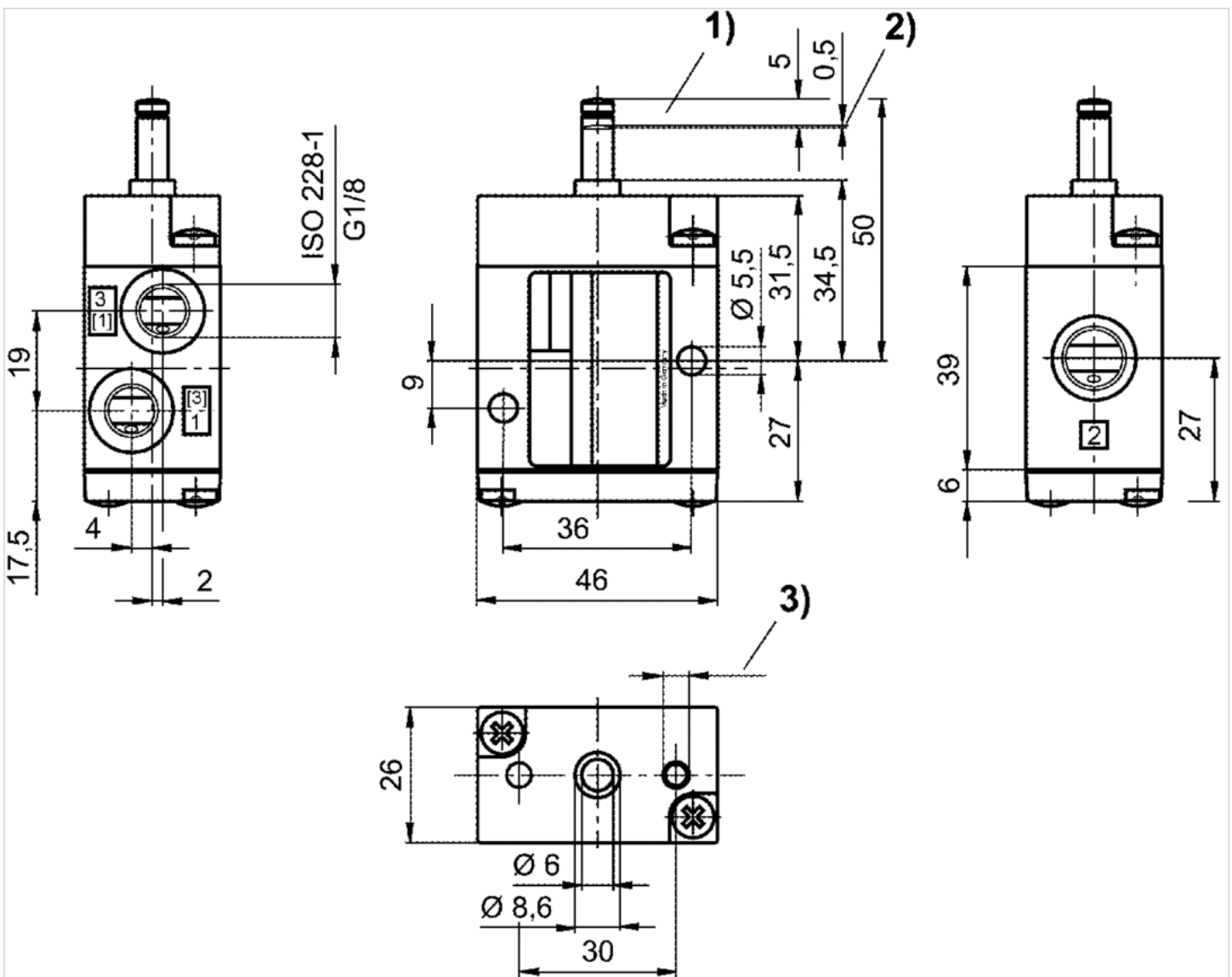

1) Stroke 2) Overstroke 3) $\varnothing 4.5 - 12$ mm deep

Dimensions, Fig. 2

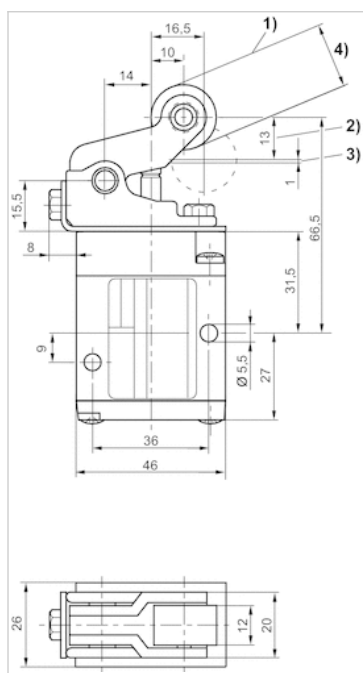

- 1) approach angle of rollers max. 30° 2) stroke 3) overstroke
 4) 5634010100: Ø20 (POM) / R412008117: Ø19 (ST)

Dimensions, Fig. 3

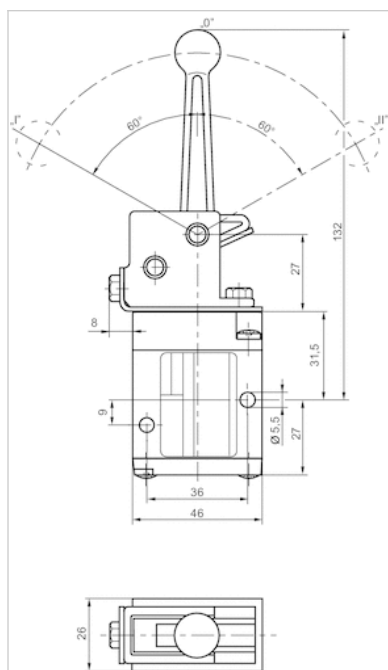

Position 0: initial position, position I: with detent, manual return, position II: automatic spring return.

Dimensions, Fig. 4

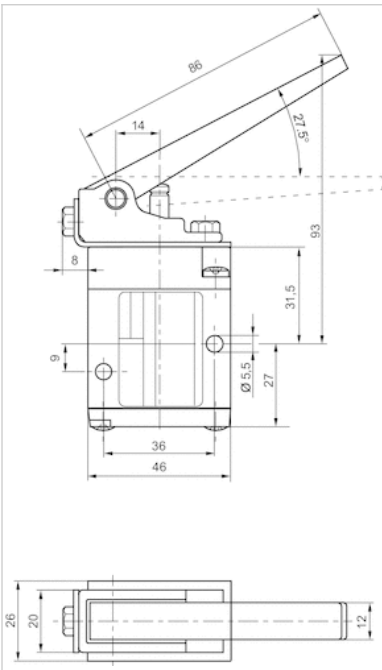

Dimensions, Fig. 5

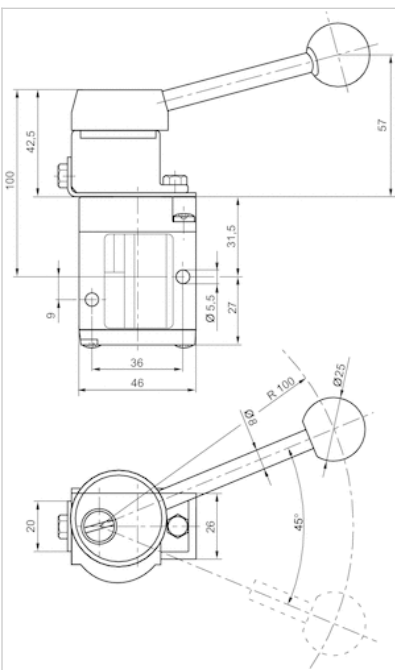

Dimensions of basic valve apply to all types of actuation.

Dimensions, Fig. 6

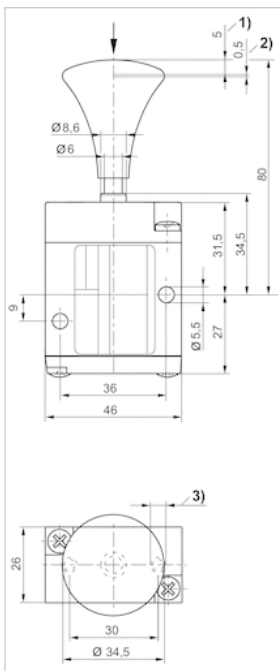

1) Stroke 2) Overstroke 3) $\varnothing 4.5$ - 12 mm deep







5/2-directional valve, Series CD04

- Qn = 900 l/min
- Compressed air connection output G 1/8
- single solenoid
- Pipe connection



Version	Spool valve, positive overlapping
Activation	Mechanical
Lock type	not lockable
Switching principle	5/2
Sealing principle	Soft sealing
Nominal flow Qn	900 l/min
Working pressure min./max.	-0.95 ... 10 bar
Ambient temperature min./max.	-20 ... 65 °C
Medium temperature min./max.	-20 ... 65 °C
Medium	Compressed air
Max. particle size	50 µm
Oil content of compressed air	0 ... 1 mg/m ³
Weight	See table below

Technical data

Part No.		Actuating element	Compressed air connection type
5634200100		Plunger	Internal thread
5634210100		Roller	Internal thread
5634230100		Hand lever, with detent, without detent	Internal thread
5634240100		Hand lever	Internal thread
5634250100		Rotary lever, with detent	Internal thread
5634260100		Button	Internal thread

Part No.	Compressed air connection Input	Compressed air connection Output	Compressed air connection Exhaust
5634200100	G 1/8	G 1/8	G 1/8
5634210100	G 1/8	G 1/8	G 1/8
5634230100	G 1/8	G 1/8	G 1/8
5634240100	G 1/8	G 1/8	G 1/8
5634250100	G 1/8	G 1/8	G 1/8
5634260100	G 1/8	G 1/8	G 1/8

Part No.	Operating force	Material actuating control	Weight	Fig.
	min.			
5634200100	70 N	Stainless steel	0.3 kg	Fig. 1
5634210100	35 N	Polyoxymethylene	0.35 kg	Fig. 2
5634230100	15 N	Polyoxymethylene	0.38 kg	Fig. 3
5634240100	60 N	Aluminum	0.31 kg	Fig. 4
5634250100	20 N	Plastic Stainless steel	0.56 kg	Fig. 5
5634260100	70 N	Polyoxymethylene	0.32 kg	Fig. 6

Nominal flow Qn at 6 bar and $\Delta p = 1$ bar

Technical information

Material	
Housing	Die cast zinc Polyamide fiber-glass reinforced
Seals	Acrylonitrile butadiene rubber
Actuating element	Stainless steel Polyoxymethylene Aluminum Plastic, Stainless steel

Dimensions

Dimensions, Fig. 1

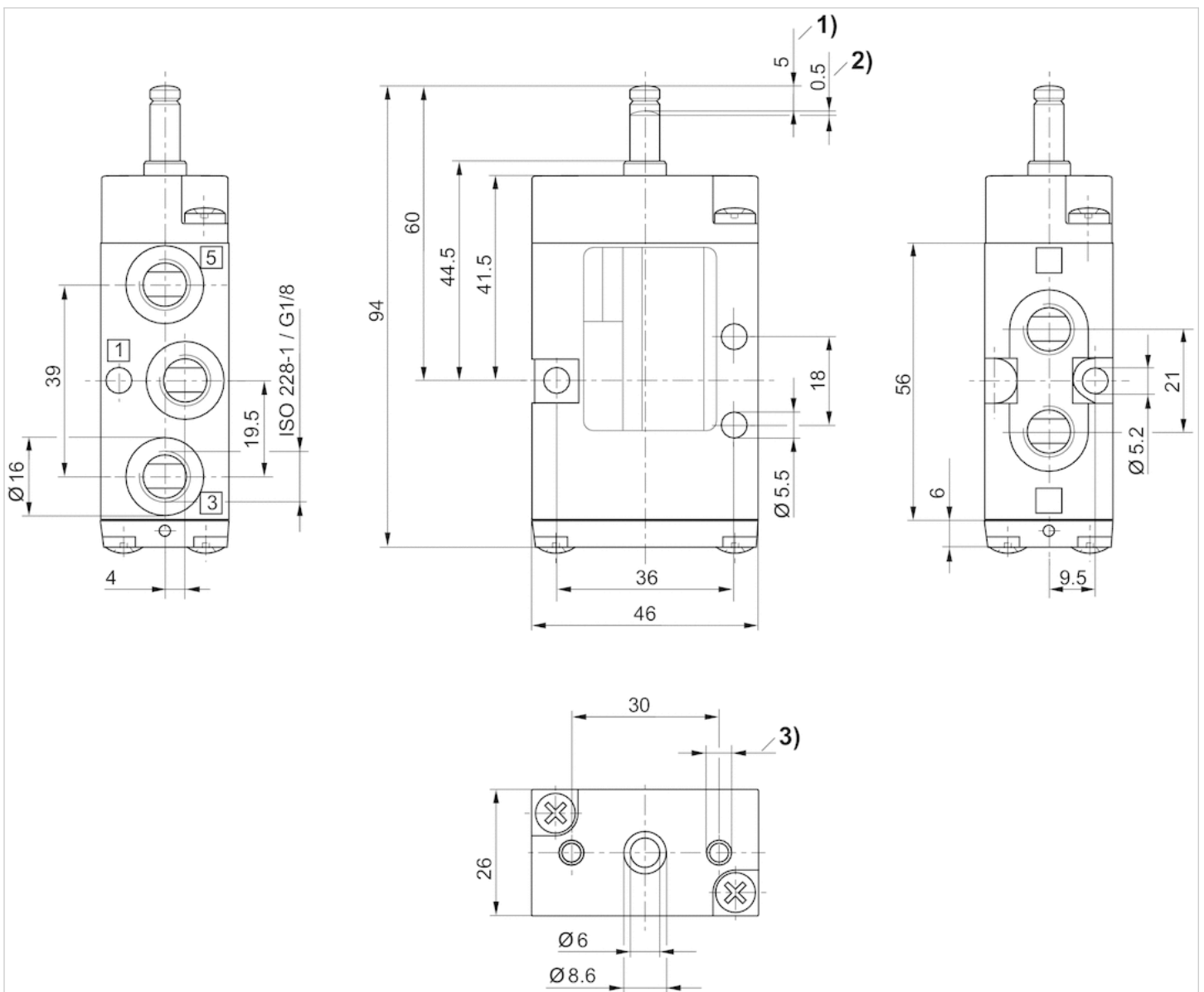

1) Stroke 2) Overstroke 3) $\varnothing 4.5$ - 12 mm deep

Dimensions, Fig. 2

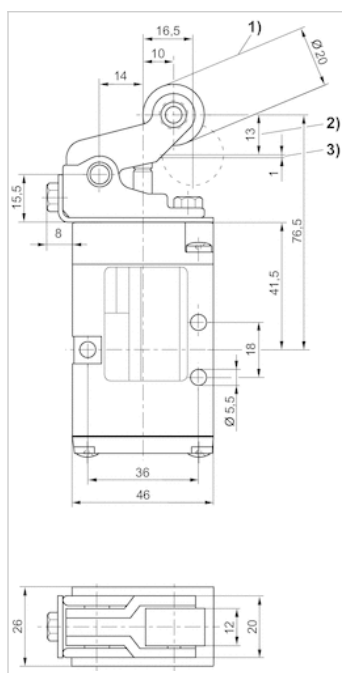

1) approach angle of rollers max. 30° 2) stroke 3) overstroke

Dimensions, Fig. 3

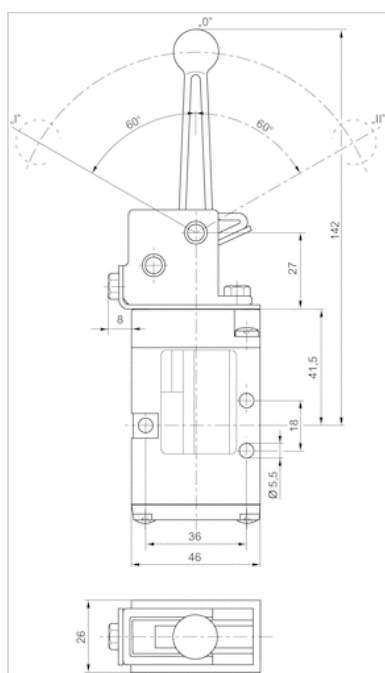

Position 0: initial position, position I: with detent, manual return, position II: automatic spring return.

Dimensions, Fig. 4

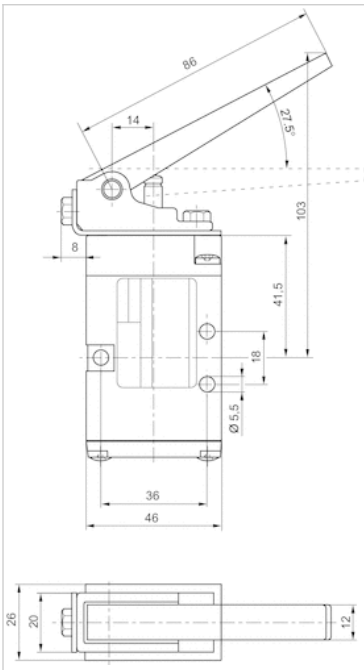

Dimensions of basic valve apply to all types of actuation.

Dimensions, Fig. 5

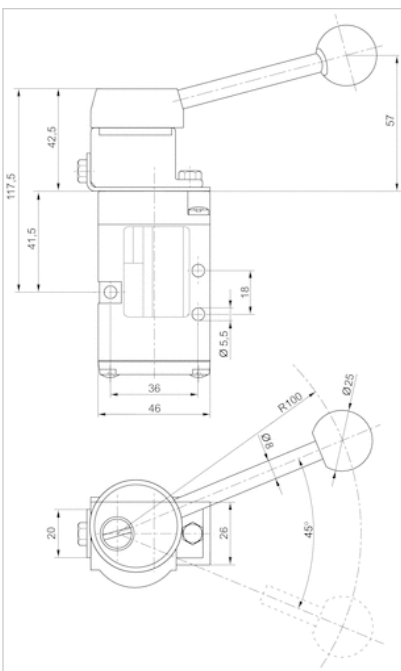

Dimensions, Fig. 6

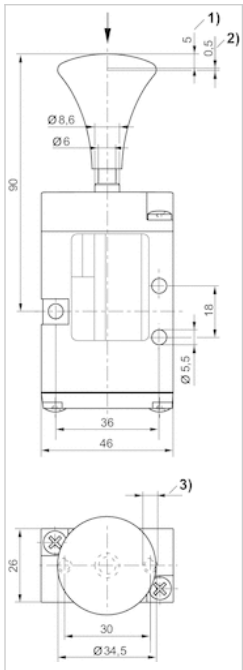

1) Stroke 2) Overstroke 3) $\varnothing 4.5$ - 12 mm deep

Valve plug connector, series CON-VP

- Socket, form B, 2+E, angled, 90°
- ISO 6952
- unshielded
- with LED Yellow Red, Red



Connection type	Screws
Ambient temperature min./max.	-25 ... 50 °C
Operational voltage	See table below
Protection class	IP65
Mounting screw tightening torque	0.4 Nm
Weight	0.02 kg

Technical data

Part No.		Operational voltage	Max. current	Protective circuit	Contact assignment
1834484096		-	10 A	-	2+E
1834484104		24 V AC/DC	-	Z-diode	2+E
1834484105		110 V AC	-	Varistor	2+E
1834484106		230 V AC	-	Varistor	2+E

Part No.	LED status display	suitable cable-Ø min./max	Seal	Fig.
1834484096	-	5 / 8 mm	caoutchouc/butadiene caoutchouc	Fig. 1
1834484104	Yellow	6 / 8 mm	Silicone caoutchouc	Fig. 2
1834484105	Red, Red	6 / 8 mm	Silicone caoutchouc	Fig. 2
1834484106	Red, Red	6 / 8 mm	Silicone caoutchouc	Fig. 2

Profile seal, Flat gasket

Technical information

The specified protection class is only valid in assembled and tested state.

Technical information

Material	
Seals	caoutchouc/butadiene caoutchouc Silicone caoutchouc

Dimensions

Fig. 1

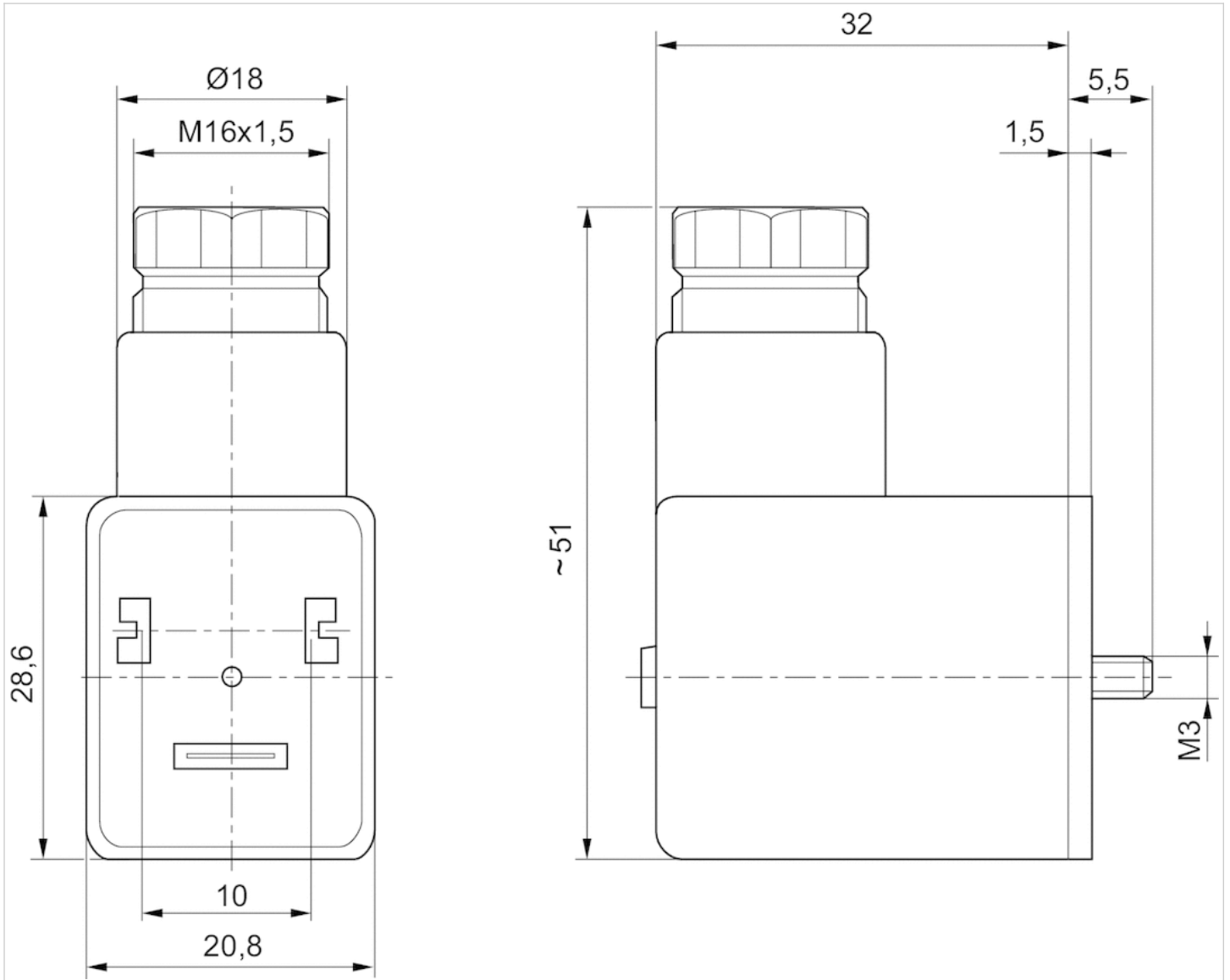
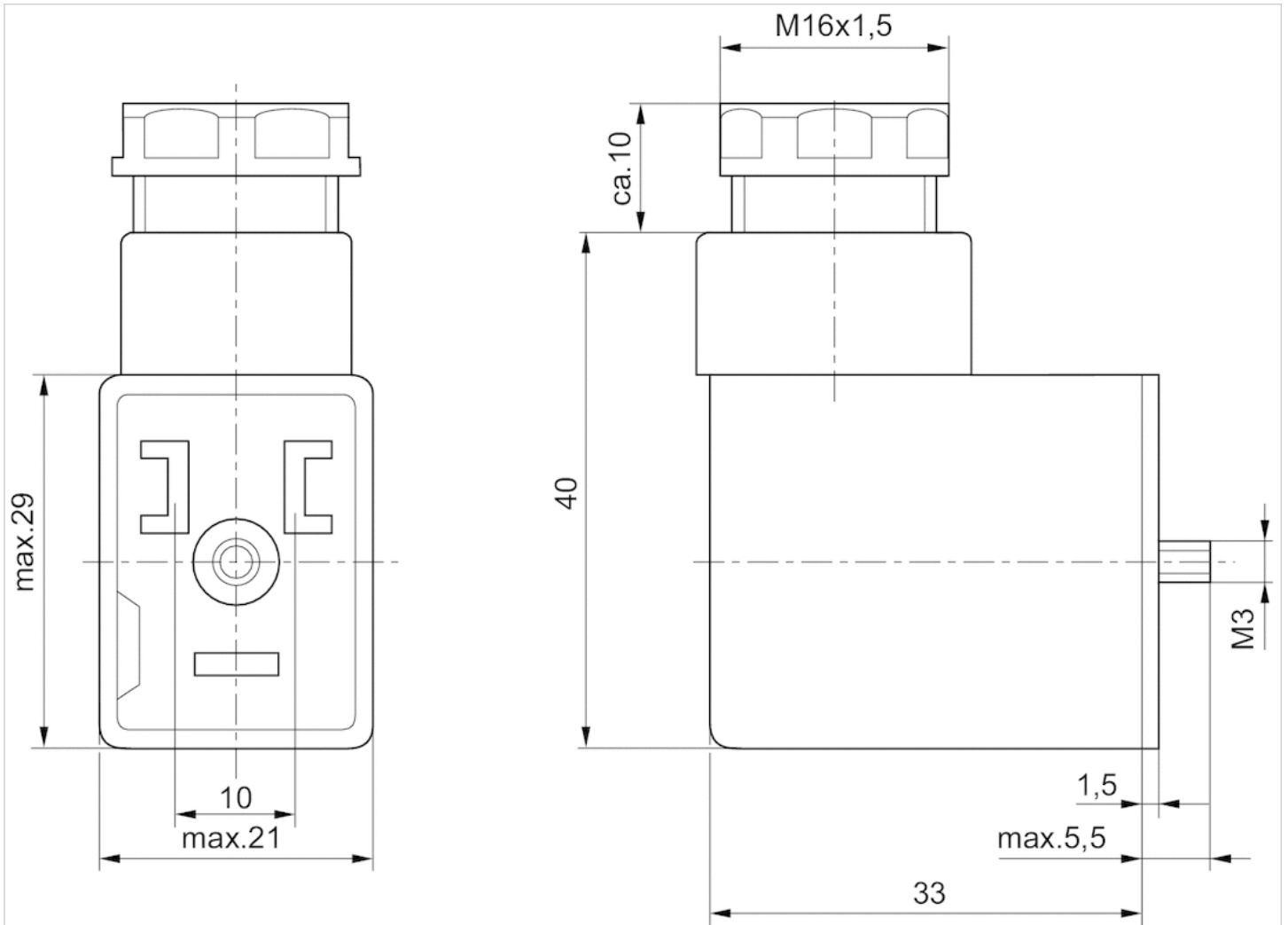

Fig. 2



Valve plug connector, series CON-VP

- Socket form B 2+E angled 90°
- open cable ends 3-pin
- with cable
- unshielded



Ambient temperature min./max.	-20 ... 80 °C
Operational voltage	24 V AC/DC
Protection class	IP67
Protective circuit	Z-diode
Wire cross-section	0.75 mm ²
Mounting screw tightening torque	0.4 Nm
Weight	See table below

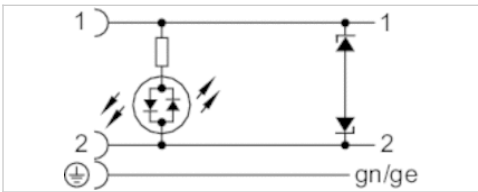

Technical data

Part No.	Max. current	Contact assignment	LED status display	Number of wires	Cable-Ø	Cable length	Weight	Fig.
1834484152	10 A	2+E	Yellow	3	5.9 mm	3 m	0.2 kg	Fig. 1
1834484153	10 A	2+E	Yellow	3	5.9 mm	3 m	0.2 kg	Fig. 2
1834484154	10 A	2+E	Yellow	3	5.9 mm	5 m	0.31 kg	Fig. 1
1834484155	10 A	2+E	Yellow	3	5.9 mm	5 m	0.31 kg	Fig. 2

Scope of delivery incl. flat gasket

Technical information

The specified protection class is only valid in assembled and tested state.

Technical information

Material	
Seals	caoutchouc/butadiene caoutchouc
Cable sheath	Polyvinyl chloride

Dimensions

Fig. 1

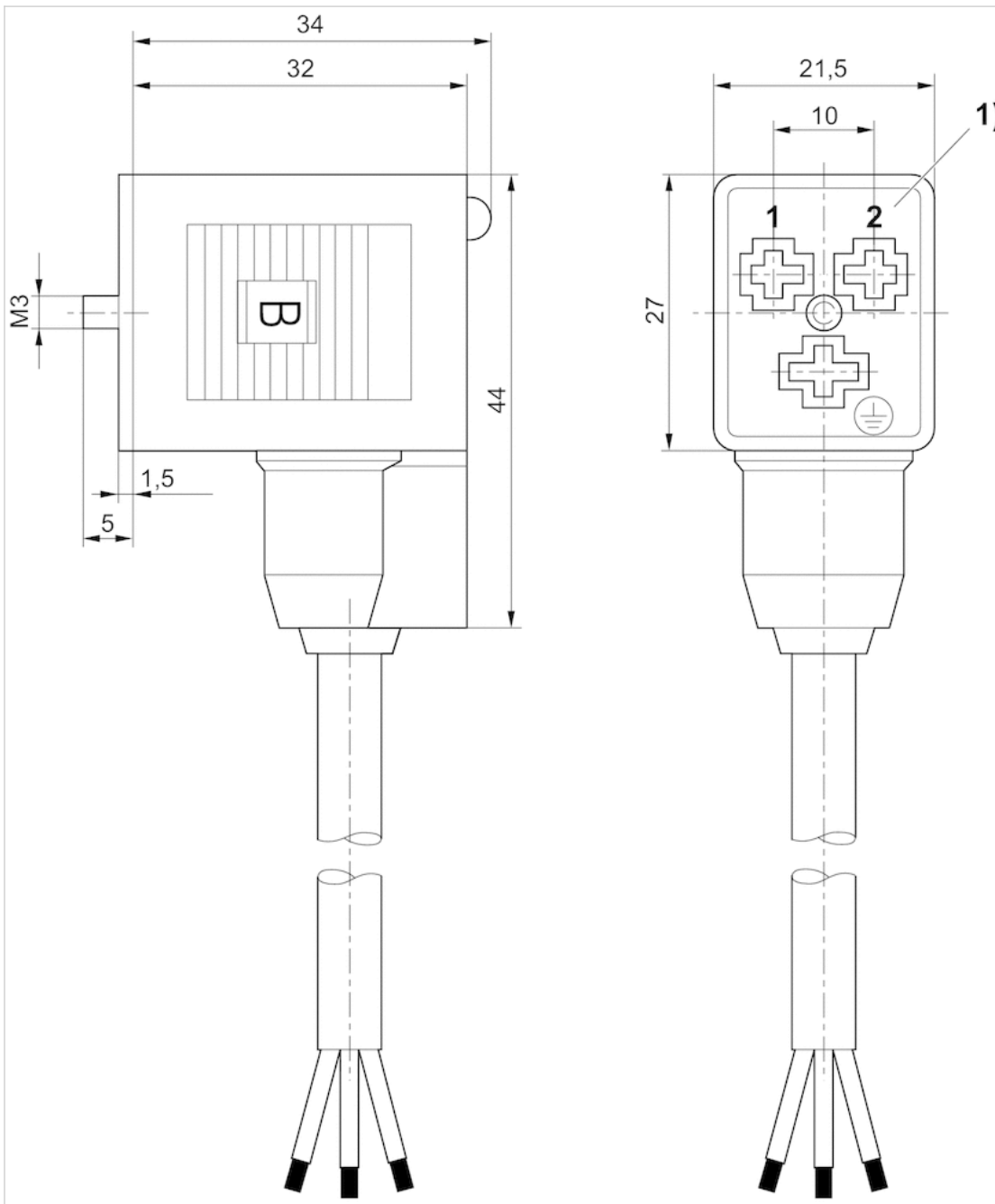

1) 0° female insert

Fig. 2

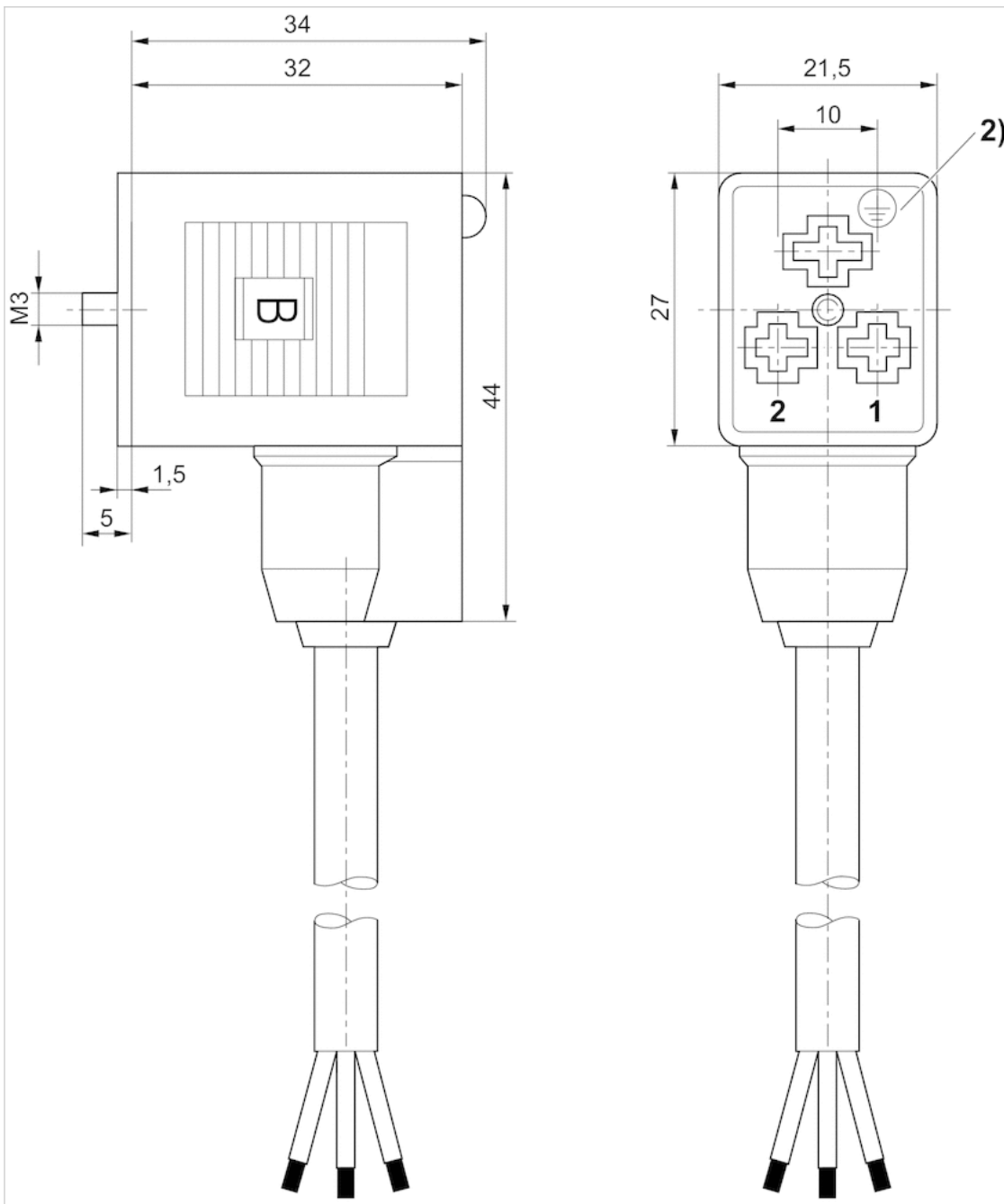

2) 180° female insert

Coil, Series C01

- form B
- Coil width 22 mm
- Power consumption DC 2.6-5.9 W
- Holding power AC 7.7-9.7 VA
- Switch-on power AC 10.5-12.6 VA



Connector standard	EN 175301-803, form B
electrical connections	Plug, 3-pin
Ambient temperature min./max.	50 °C
Protection class With valve plug connector/plug	IP65
Duty cycle ED	100 %
Weight	0.07 kg

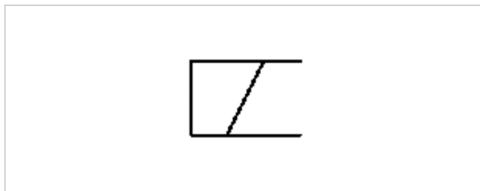

Technical data

Part No.	Operational voltage	Operational voltage	Operational voltage
	DC	AC 50 Hz	AC 60 Hz
1824210245	24 V	-	-
1824210239	12 V	24 V	24 V
1824210243	24 V	48 V	48 V
1824210241	48 V	-	-
1824210237	60 V	110 V	110 V
1824210235	110 V	220 V	230 V

Part No.	Voltage tolerance	Voltage tolerance	Voltage tolerance	Power consumption
	DC	AC 50 Hz	AC 60 Hz	DC
1824210245	-10% / +10%	-10% / +10%	-10% / +10%	2.6 W
1824210239	-10% / +10%	-10% / +10%	-10% / +10%	5.5 W
1824210243	-10% / +10%	-10% / +10%	-10% / +10%	4.8 W
1824210241	-10% / +10%	-10% / +10%	-10% / +10%	5 W
1824210237	-10% / +10%	-10% / +10%	-10% / +10%	5.9 W
1824210235	-10% / +10%	-10% / +10%	-10% / +10%	4.9 W

Part No.	Holding power	Holding power	Switch-on power	Switch-on power
	AC 50 Hz	AC 60 Hz	AC 50 Hz	AC 60 Hz
1824210245	-	-	-	-
1824210239	8.9 VA	7.3 VA	12 VA	9.9 VA

Part No.	Holding power	Holding power	Switch-on power	Switch-on power
	AC 50 Hz	AC 60 Hz	AC 50 Hz	AC 60 Hz
1824210243	7.7 VA	6.2 VA	10.5 VA	9.4 VA
1824210241	-	-	-	-
1824210237	8.4 VA	6.8 VA	11 VA	9.4 VA
1824210235	9.7 VA	7.9 VA	12.6 VA	10.2 VA

Part No.	Compatibility index
1824210245	13
1824210239	14
1824210243	14
1824210241	14
1824210237	14
1824210235	14

Technical information

Material	
Housing	Thermoplastic elastomer

Dimensions

Dimensions

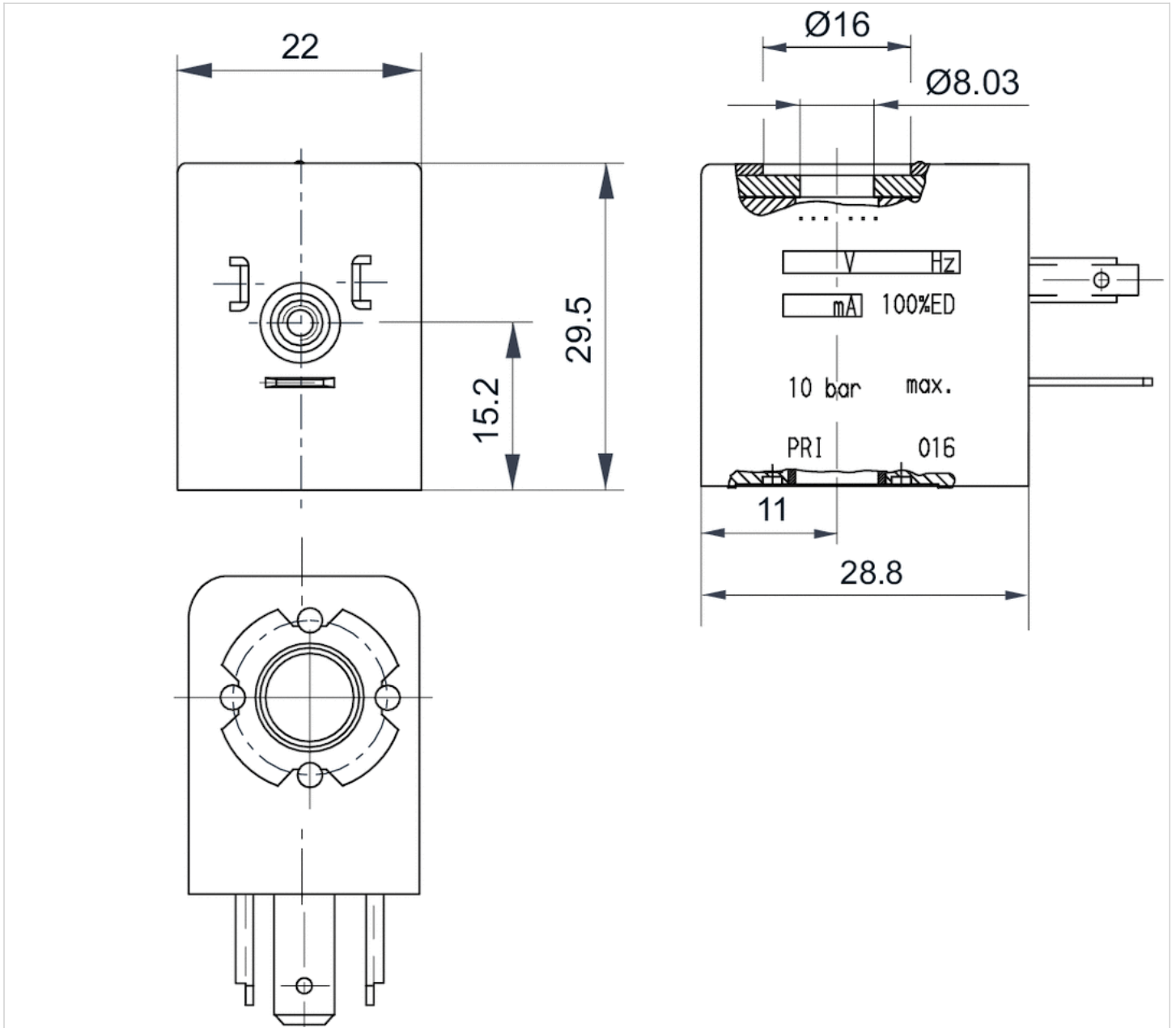

Silencers, series SI1

- G 1/8
- Sintered bronze



Working pressure min./max.	0 ... 10 bar
Ambient temperature min./max.	-25 ... 80 °C
Medium	Compressed air
Sound pressure level	75 dB
Weight	0.01 kg
Comment	Flow characteristic curves can be found under "Diagrams".

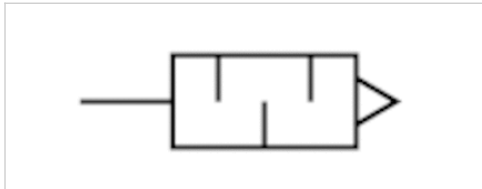

Technical data

Part No.	Compressed air connection	Flow	Delivery unit
		Qn	
1827000000	G 1/8	1623 l/min	10 piece

Weight per piece

Nominal flow Qn at p1 = 6 bar (absolute) freely discharged. Sound pressure level measured at 6 bar against atmosphere at 1 m distance.

Technical information

Material	
Silencer	Sintered bronze
Thread	Brass

Dimensions

Dimensions in mm

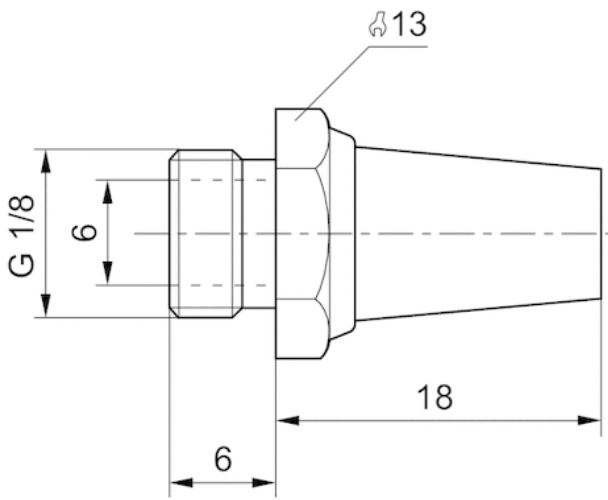

Diagrams

Flow diagram, 1827000000

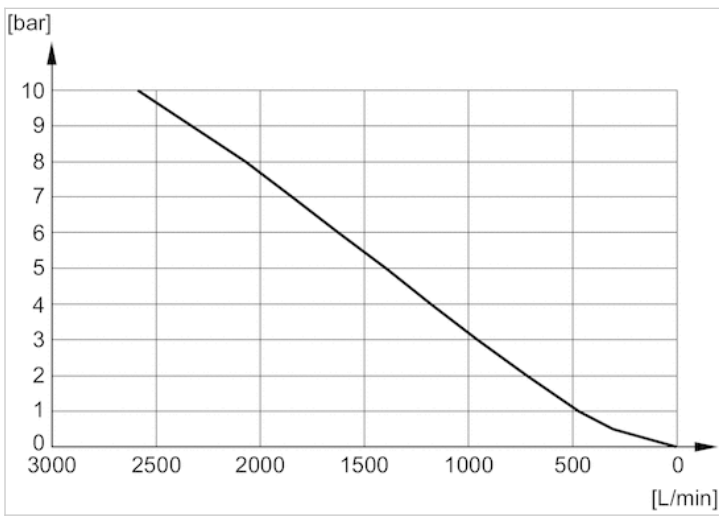

Silencers, series SI1

- G 1/8
- Sintered bronze



Working pressure min./max.	0 ... 10 bar
Ambient temperature min./max.	-25 ... 80 °C
Medium	Compressed air
Sound pressure level	85 dB
Weight	0.001 kg
Comment	Flow characteristic curves can be found under "Diagrams".

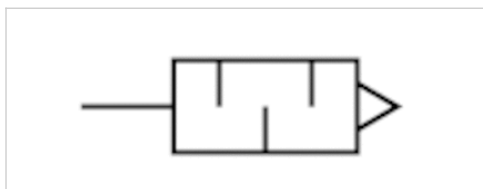

Technical data

Part No.	Compressed air connection	Flow	Delivery unit
		Qn	
1827000031	G 1/8	700 l/min	10 piece

Weight per piece

Nominal flow Qn at p1 = 6 bar (absolute) freely discharged. Sound pressure level measured at 6 bar against atmosphere at 1 m distance.

Technical information

Material	
Silencer	Sintered bronze
Thread	Brass

Dimensions

Dimensions

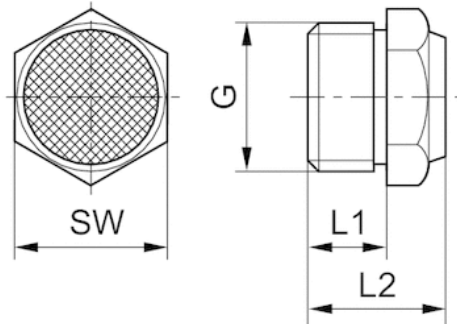

Dimensions

Part No.	Port G	L1	L2	SW
1827000031	G 1/8	6	11.5	13

Sound pressure level measured at 6 bar at 1 m distance

Diagrams

Flow diagram, 1827000032

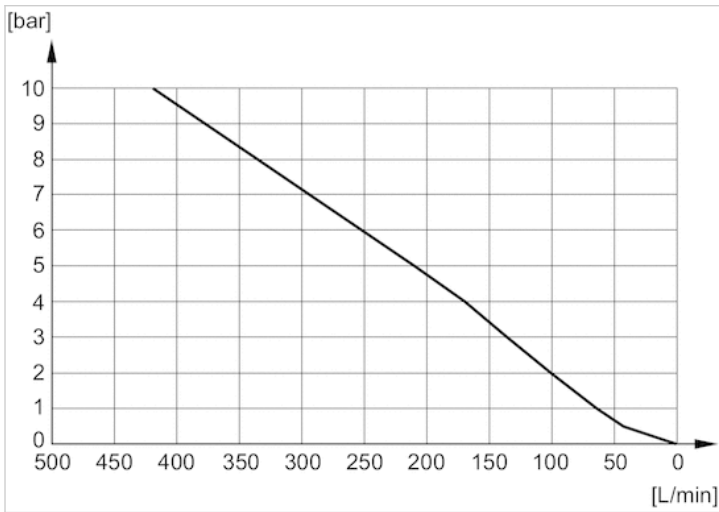

Flow diagram, 1827000031

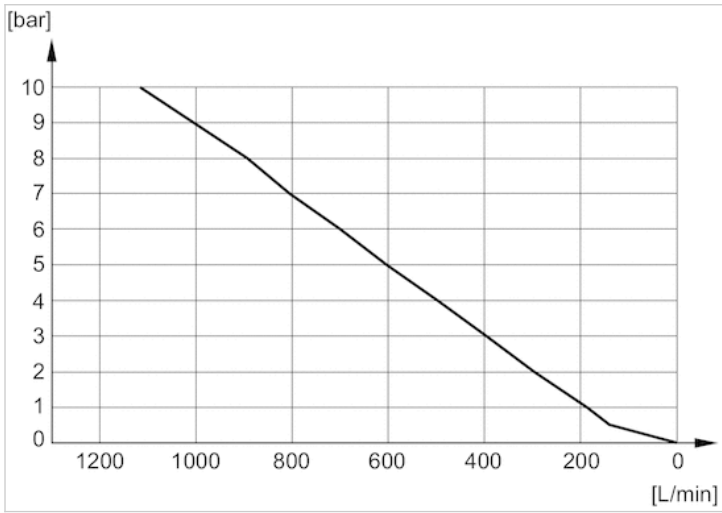

Flow diagram, 1827000033

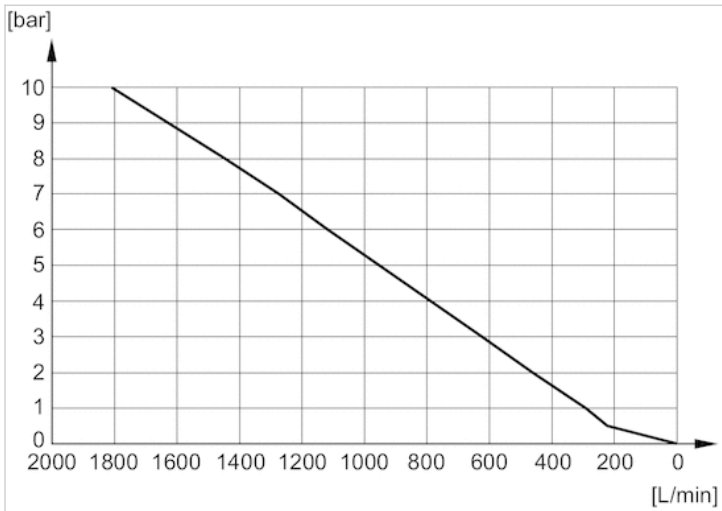

Flow diagram, 1827000034

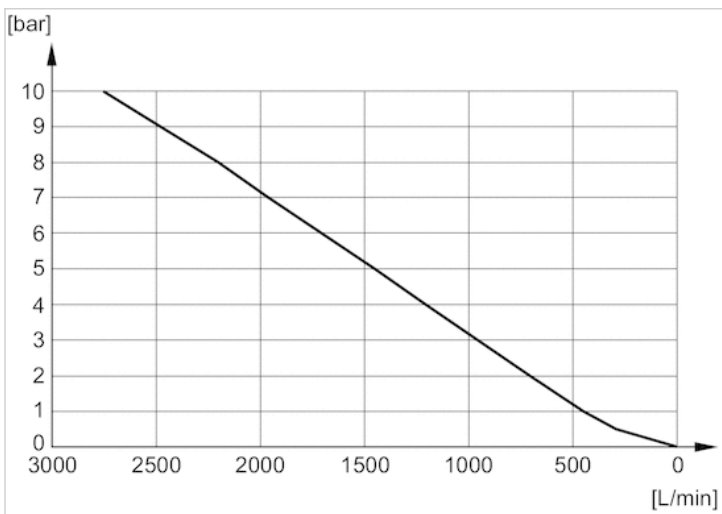

Flow diagram, 1827000035

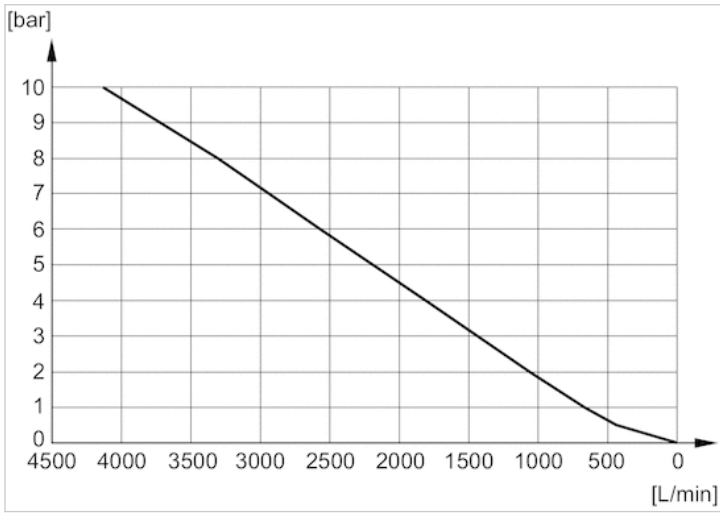

Flow diagram, 8145003400

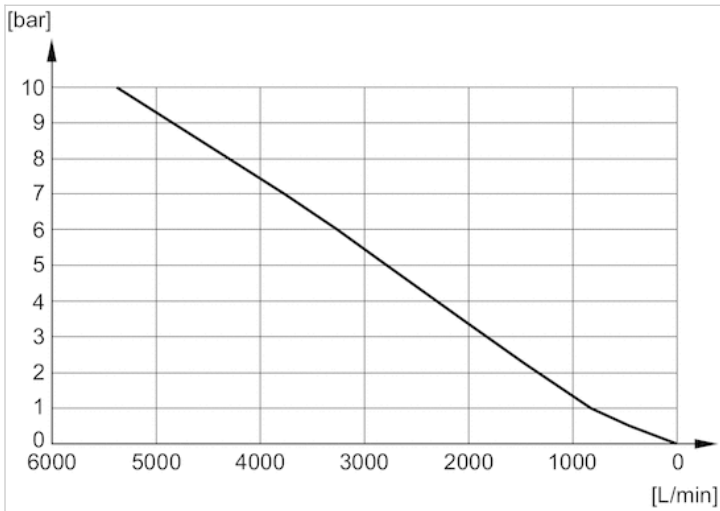

Flow diagram, 8145001000

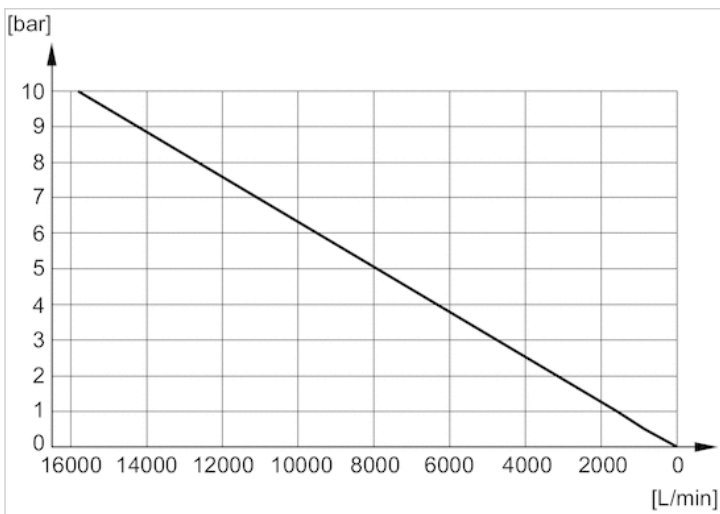

Silencers, series SI1

- G 1/8
- Sintered bronze



Working pressure min./max.

0 ... 10 bar

Ambient temperature min./max.

-25 ... 80 °C

Medium

Compressed air

Comment

Flow characteristic curves can be found under "Diagrams".

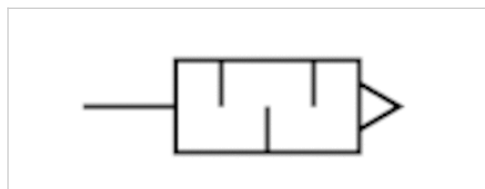

Technical data

Part No.	Compressed air connection	Flow	Delivery unit
		Qn	
1827430004	G 1/8	311 l/min	10 piece

Nominal flow Qn at p1 = 6 bar (absolute) freely discharged. Sound pressure level measured at 6 bar against atmosphere at 1 m distance.

Technical information

Material	
Silencer	Sintered bronze
Thread	Brass

Dimensions

Dimensions

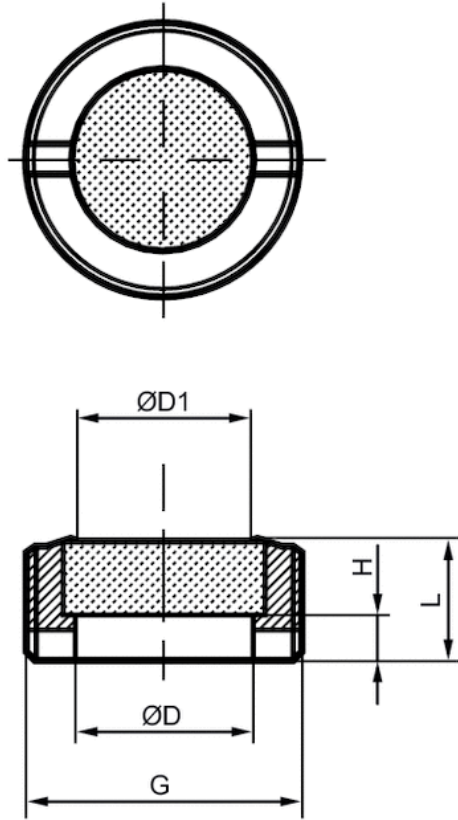

Dimensions

Part No.	Port G	$\varnothing D$	$\varnothing D1$	H	L
1827430004	G 1/8	6	5	2	4

Diagrams

Flow diagram, 1827430004

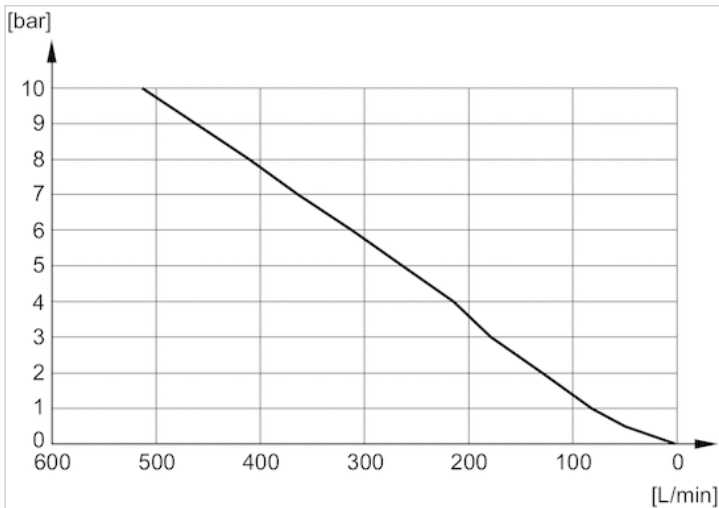

Flow diagram, R414000155

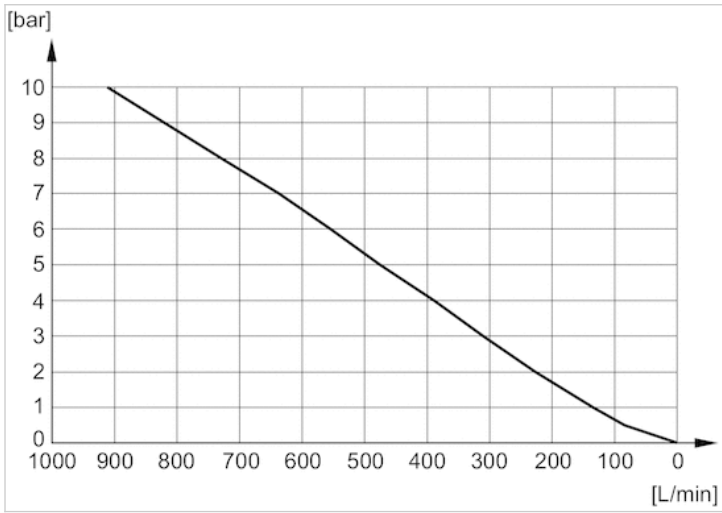

R412007875

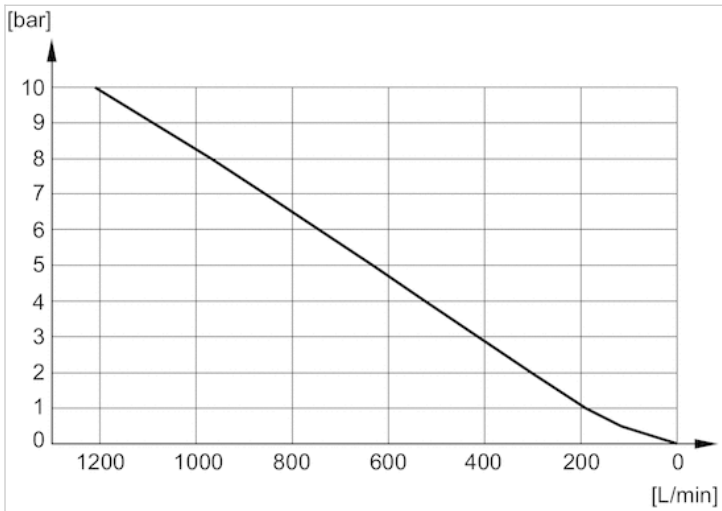

Flow diagram, R412007876

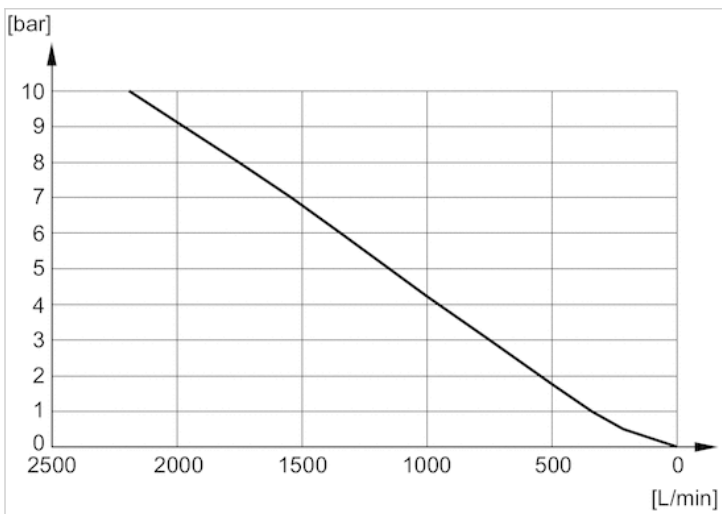

Flow diagram, R412007877

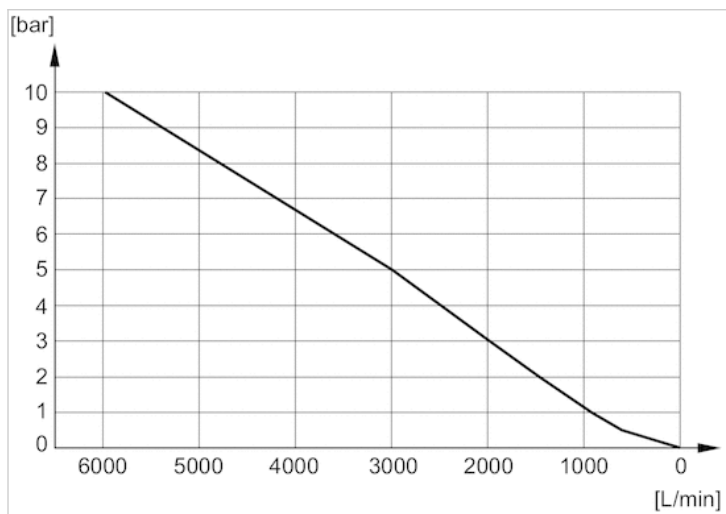

Flow diagram, R412007878

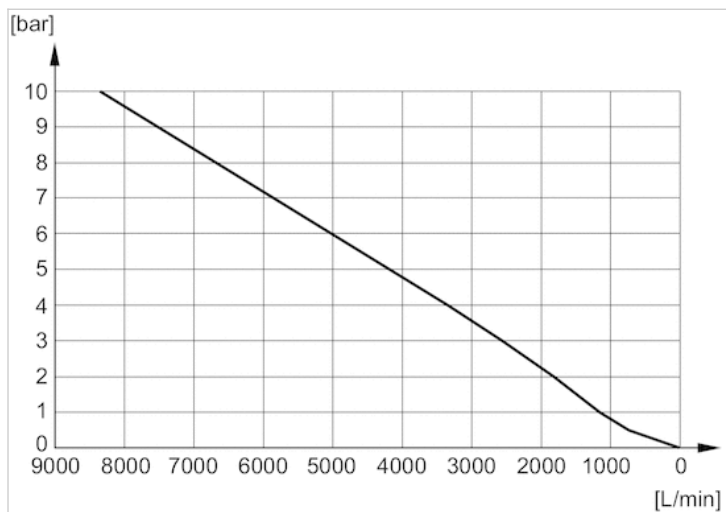

Silencers, series SI1

- G 1/8
- Polyethylene



Working pressure min./max.	0 ... 10 bar
Ambient temperature min./max.	-25 ... 80 °C
Medium	Compressed air
Sound pressure level	78 dB
Weight	0.002 kg

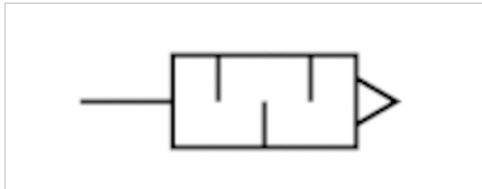

Technical data

Part No.	Compressed air connection	Flow	Delivery unit
		Qn	
1827000019	G 1/8	1560 l/min	5 piece

Weight per piece

Nominal flow Qn at p1 = 6 bar (absolute) freely discharged. Sound pressure level measured at 6 bar against atmosphere at 1 m distance.

Technical information

Flow characteristic curves can be found under "Diagrams".

Technical information

Material	
Silencer	Polyethylene
Thread	Polyethylene

Dimensions

Dimensions

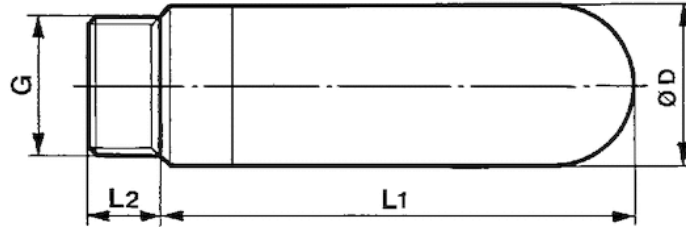

Dimensions

Part No.	Port G	Ø D	L1	L2
1827000019	G 1/8	12.5	28.5	5.5

Diagrams

Flow diagram, 1827000018

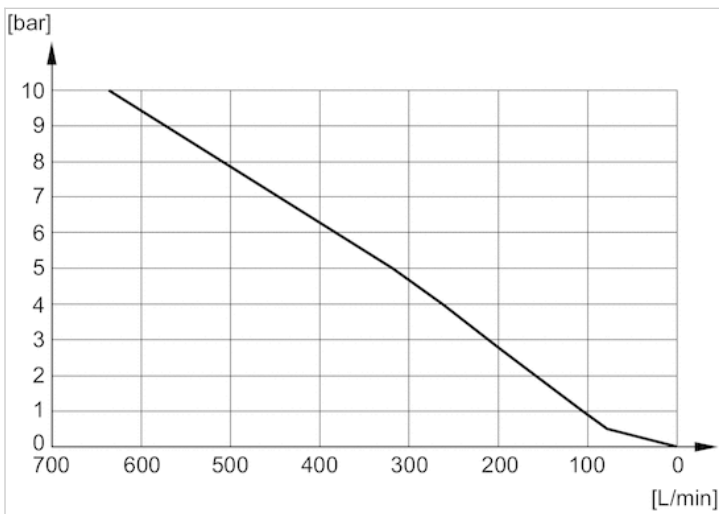

Flow diagram, 1827000019

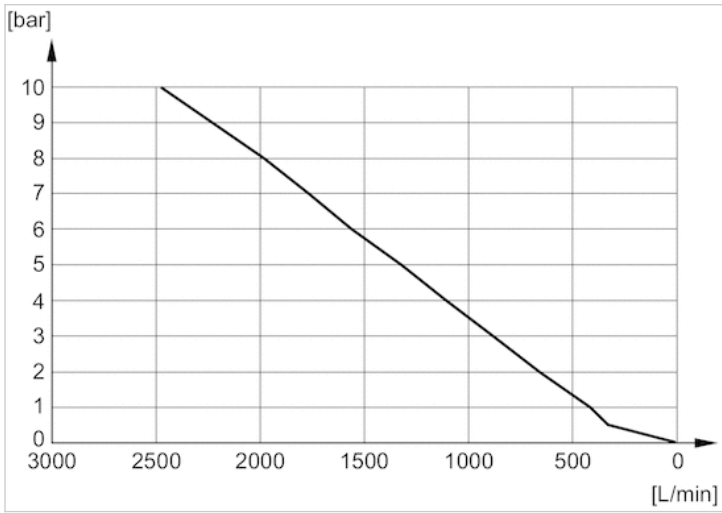

Flow diagram, 1827000020

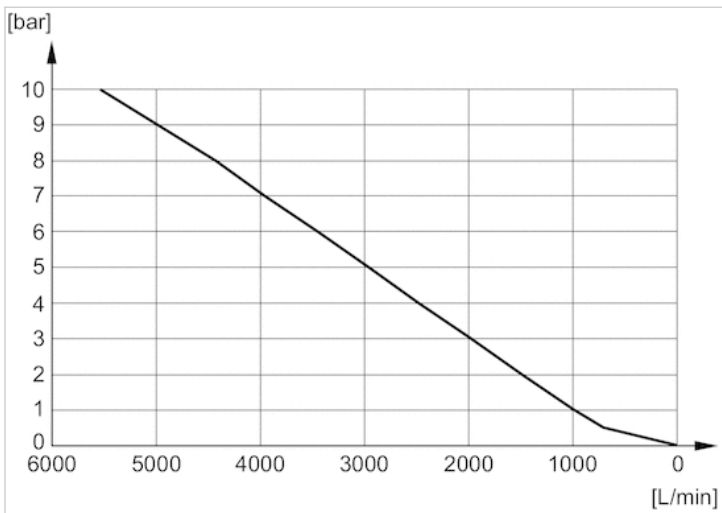

Flow diagram, 1827000021

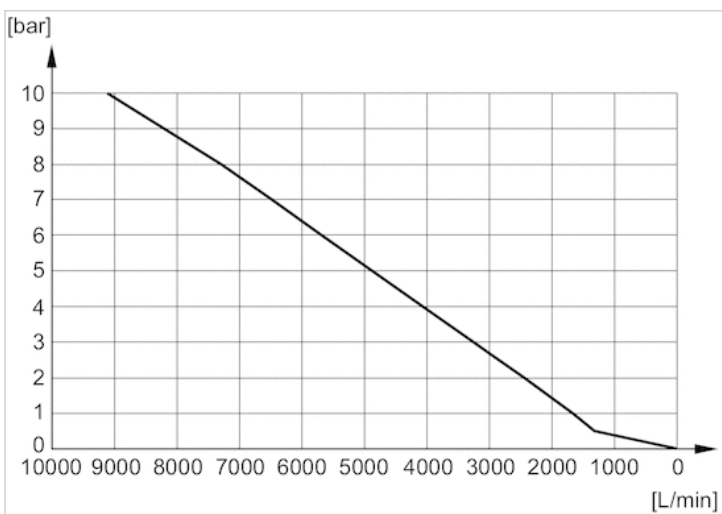

Flow diagram, 1827000022

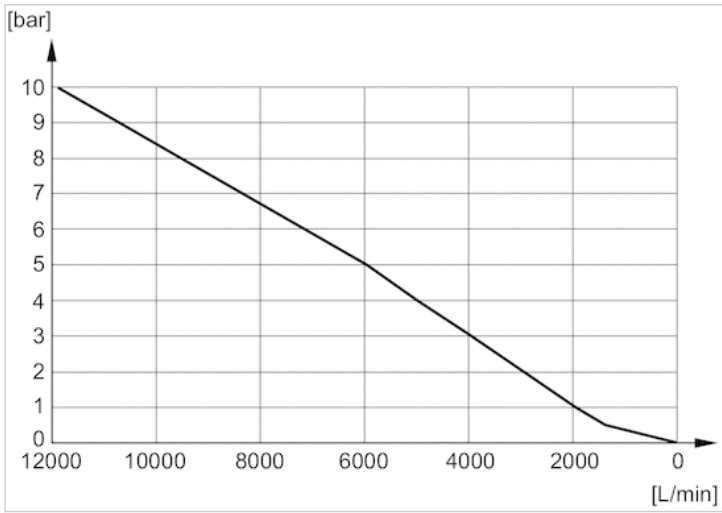

Flow diagram, 1827000023

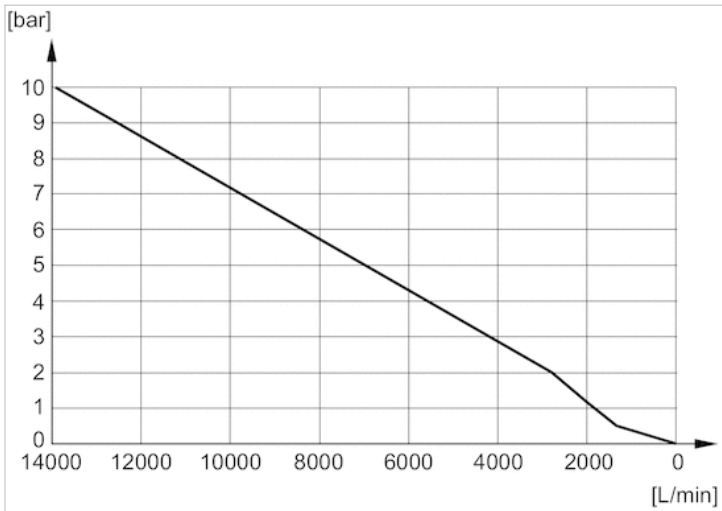

Flow diagram, 1827000024

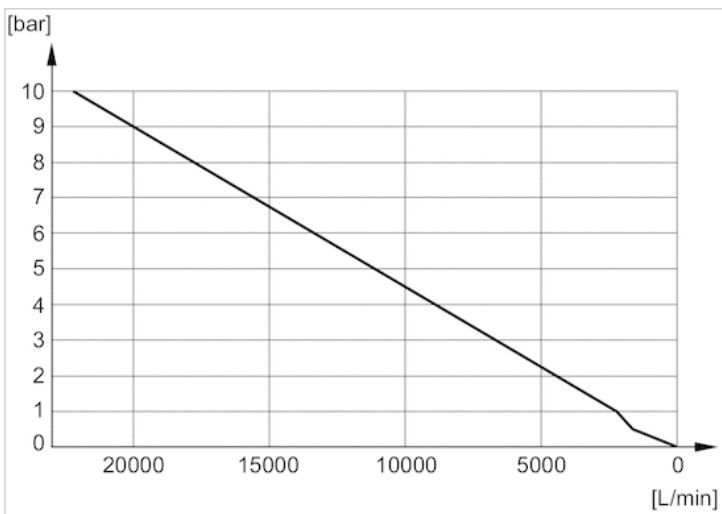

Manifold strip, Series CD04

- 5/2 and 5/3-directional valves



Compressed air connection	according to ISO 228-1
Working pressure min./max.	-0.95 ... 16 bar
Ambient temperature min./max.	-25 ... 80 °C
Medium temperature min./max.	-25 ... 80 °C
Medium	Compressed air
Exhaust (3,5)	uncollected exhaust

Technical data

Part No.	Compressed air connection Input [1]	Number of valve positions
3337110222	Ø 10x1	2
3337110232	Ø 10x1	3
3337110242	Ø 10x1	4
3337110252	Ø 10x1	5
3337110262	Ø 10x1	6
3337110272	Ø 10x1	7
3337110282	Ø 10x1	8
3337110292	Ø 10x1	9
3337110302	Ø 10x1	10
3337110312	Ø 10x1	11
3337110322	Ø 10x1	12

Technical information

The min. control pressure must be adhered to, since otherwise faulty switching and valve failure may result!

The pressure dew point must be at least 15 °C under ambient and medium temperature and may not exceed 3 °C .

The oil content of compressed air must remain constant during the life cycle.

Use only the approved oils from AVENTICS. Further information can be found in the "Technical information" document (available in the MediaCentre).

Technical information

Material	
Base plate	Aluminum Polyoxymethylene
Seal	Acrylonitrile butadiene rubber
Mounting bracket	Steel

Dimensions

Dimensions

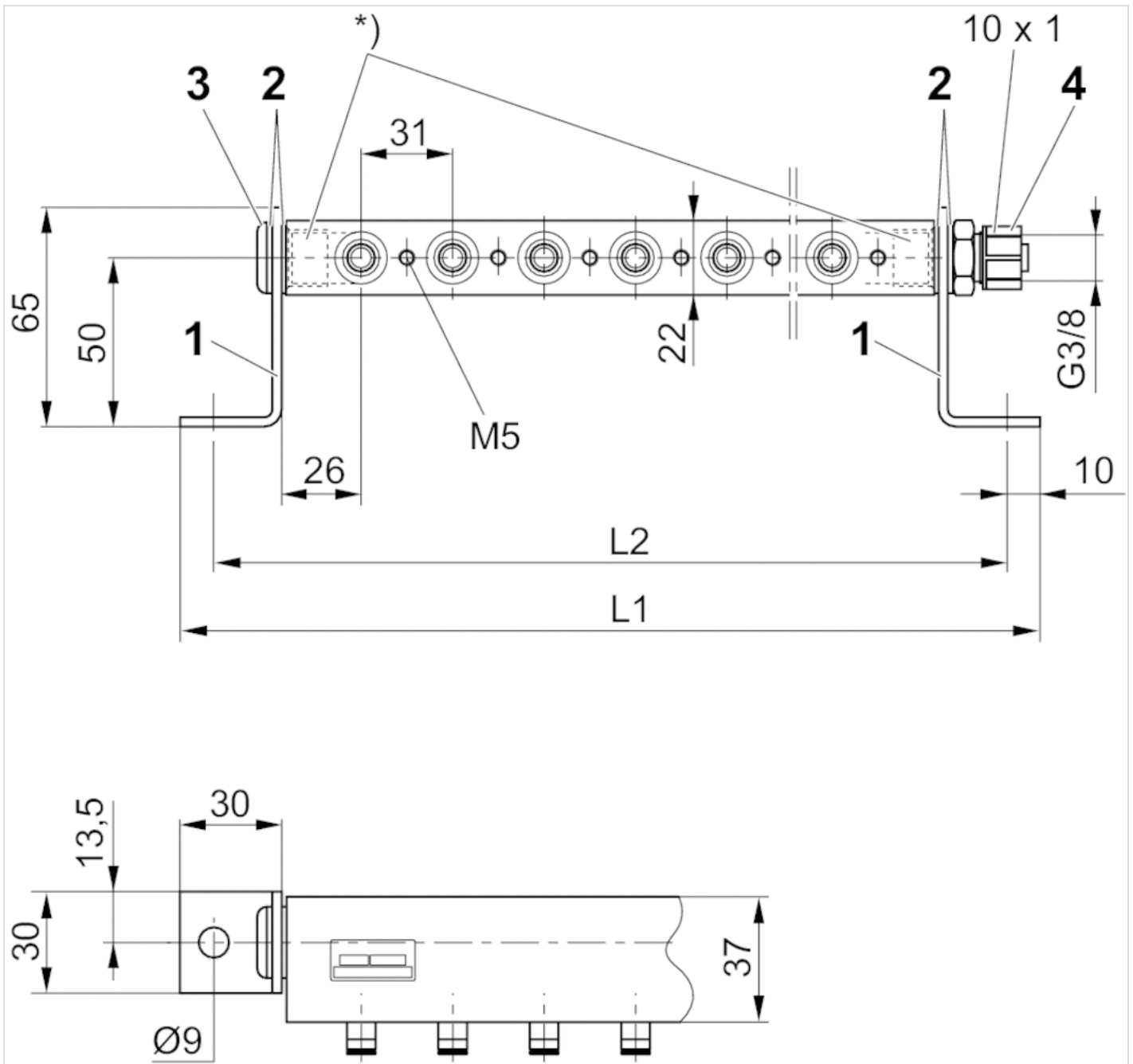

Angled bracket (1), seal DIN 7603 AI (2), blanking screw G 3/8 ISO 228/1 (3), push-in fittings G 3/8 ISO 228/1, diameter 10x1 (4)

* Only use fittings with max. length of thread engagement equal to 12 mm.

Valve mounting screws (depending on the valve used): washer, screw, O-ring must be ordered separately.

Dimensions

Part No.	L1	L2
3337110222	142	122
3337110232	169	149
3337110242	196	176
3337110252	223	203

Part No.	L1	L2
3337110262	250	230
3337110272	277	257
3337110282	304	284
3337110292	331	311
3337110302	358	338
3337110312	385	365
3337110322	412	392

R, P, S subbase, Series CD04

- 5/2 and 5/3-directional valves



Compressed air connection	according to ISO 228-1
Working pressure min./max.	-0.95 ... 16 bar
Ambient temperature min./max.	-25 ... 80 °C
Medium temperature min./max.	-25 ... 80 °C
Medium	Compressed air
Exhaust (3,5)	With directional exhaust (3/5)
Exhaust type	Ports separated
Weight	See table below

Technical data

Part No.	Compressed air connection Input [1]	Compressed air connection Exhaust [3 / 5]
8985070042	G 3/8	G 3/8
8985070062	G 3/8	G 3/8
8985070082	G 3/8	G 3/8
8985070102	G 3/8	G 3/8
8985070122	G 3/8	G 3/8

Part No.	Compressed air connection Pilot connection [X]	Number of valve positions	Weight
8985070042	G 1/8	4	1.3 kg
8985070062	G 1/8	6	1.8 kg
8985070082	G 1/8	8	2.3 kg
8985070102	G 1/8	10	2.7 kg
8985070122	G 1/8	12	3.2 kg

Technical information

The min. control pressure must be adhered to, since otherwise faulty switching and valve failure may result!

The pressure dew point must be at least 15 °C under ambient and medium temperature and may not exceed 3 °C .

The oil content of compressed air must remain constant during the life cycle.

Use only the approved oils from AVENTICS. Further information can be found in the "Technical information" document (available in the MediaCentre).

Order 3354800092 coupling kit separately

Technical information

Material	
Base plate	Aluminum Polyoxymethylene
Seal	Acrylonitrile butadiene rubber

Dimensions

Dimensions

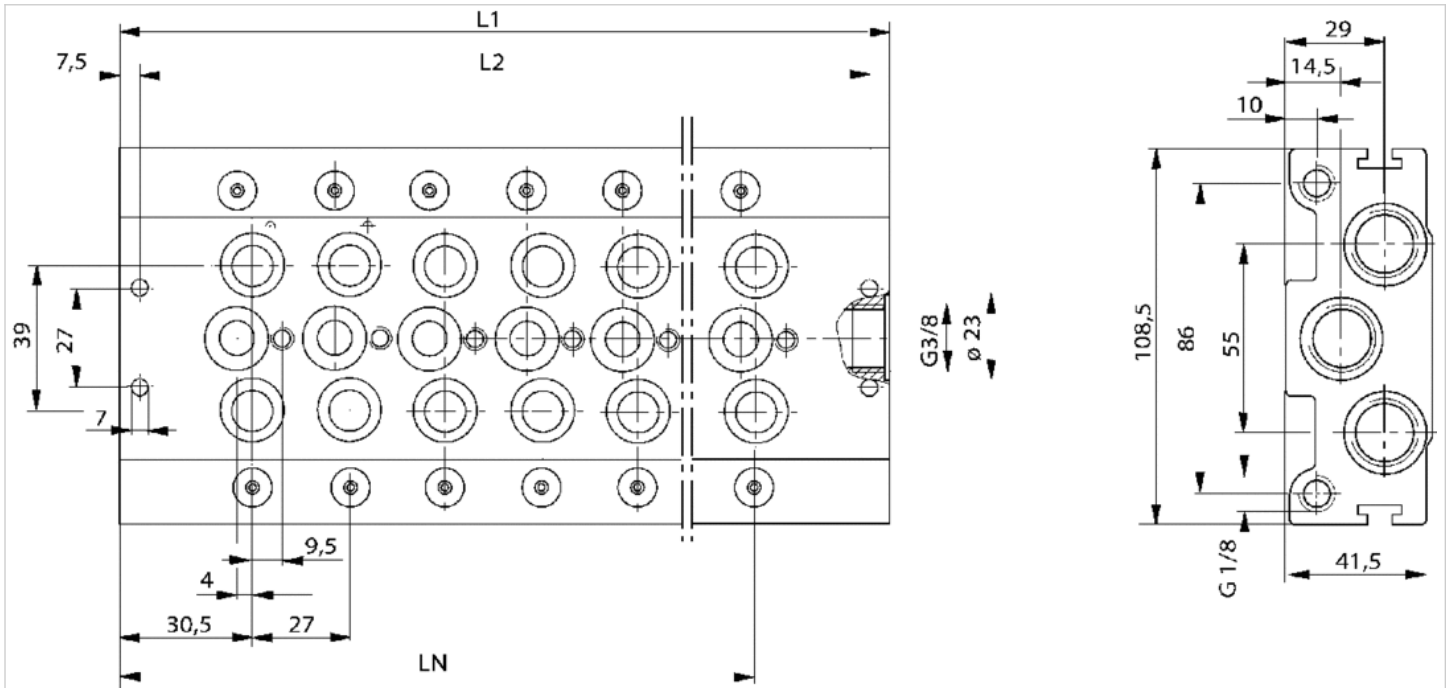

Order 3354800092 coupling kit separately

Dimensions

Part No.	L1	L2	LN	Weight
8985070042	142	127	112	1.3 kg
8985070062	196	181	166	1.8 kg
8985070082	250	235	200	2.3 kg
8985070102	304	289	274	2.7 kg
8985070122	358	343	328	3.2 kg

Blanking plate



Working pressure min./max.	-0.95 ... 16 bar
Ambient temperature min./max.	-25 ... 80 °C
Medium temperature min./max.	-25 ... 80 °C
Medium	Compressed air
Number of valve positions max.	1
Weight	0.104 kg

Technical data

Part No.
3354801004

Technical information

The min. control pressure must be adhered to, since otherwise faulty switching and valve failure may result!
 The pressure dew point must be at least 15 °C under ambient and medium temperature and may not exceed 3 °C .
 The oil content of compressed air must remain constant during the life cycle.
 Use only the approved oils from AVENTICS. Further information can be found in the "Technical information" document (available in the MediaCentre).

Technical information

Material	
Base plate	Aluminum

Dimensions

Dimensions

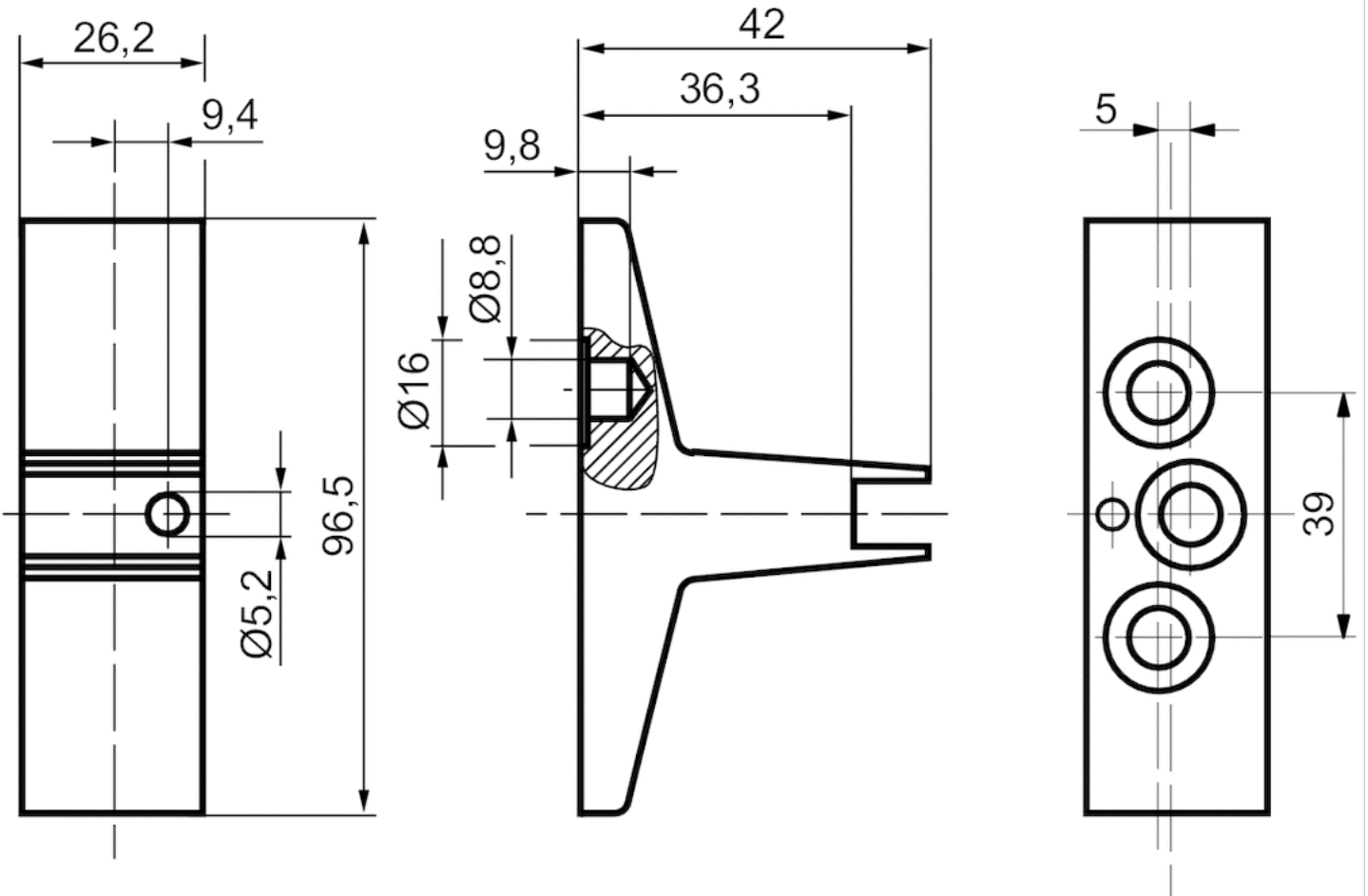

Accessories

- for CD04



Weight

See table below

Technical data

Part No.	Fig.	Type
3354800092	Fig. 1	Mounting kit for 10 valves, delivery includes: 30 seals, 10 washers, and 10 mounting screws.
3354800082	Fig. 2	P plug
3354800072	Fig. 3	R/S plug

Part No.	Suitable for	Weight
3354800092	R, P, S subbase	-
3354800082	R, P, S subbase	0.017 kg
3354800072	R, P, S subbase	0.022 kg

Dimensions

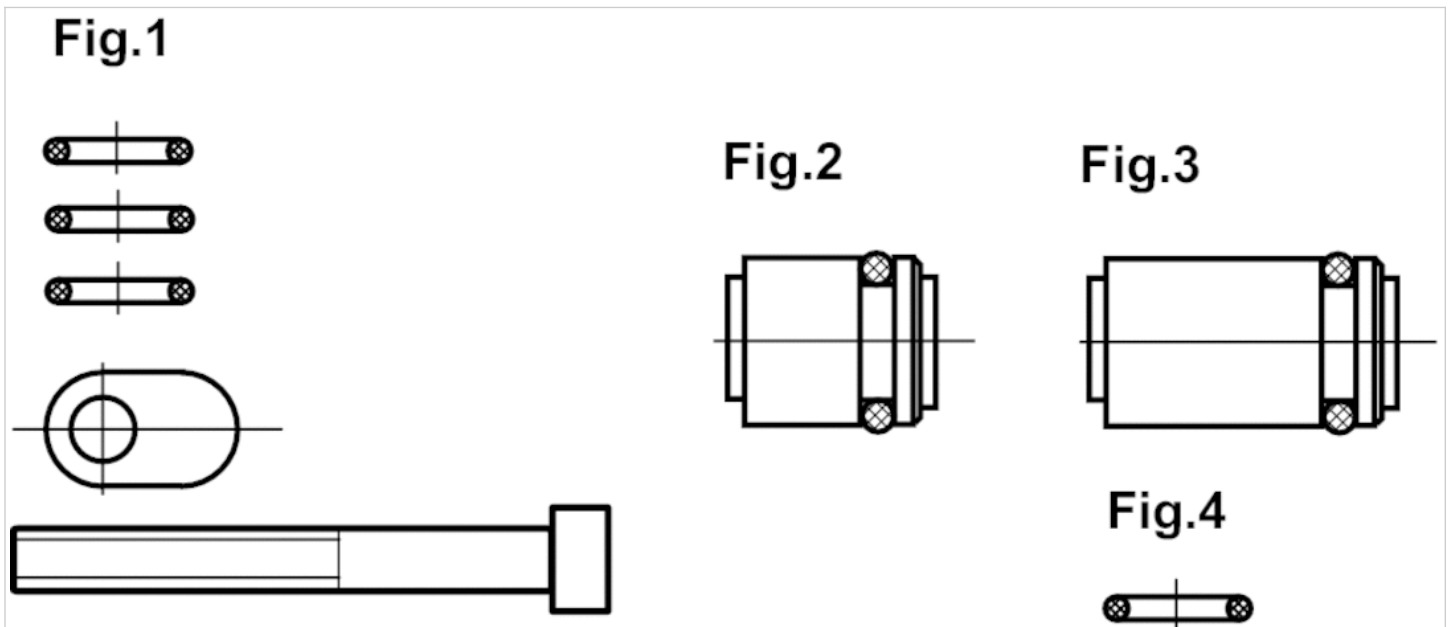

Blanking screw, gasket

- M5

- FPT-S-RBI



Working pressure min./max.

0 ... 16 bar

Ambient temperature min./max.

-20 ... 80 °C

The delivered product may vary from that in the illustration.

Technical data

Part No.	Port G	Delivery unit
1823462016	M5	25 piece

Technical information

Material	
Material	Steel, galvanized
Seal	Polyvinyl chloride, hard

Dimensions

Dimensions

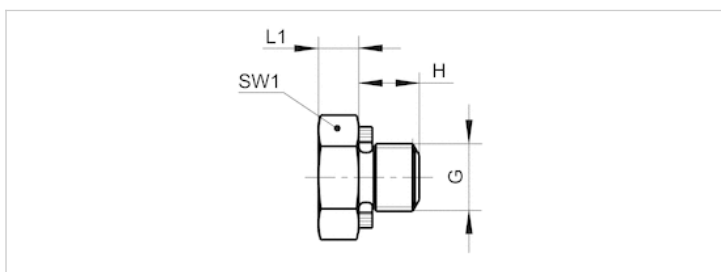

Dimensions

Port G	H	L1	SW1
M5	4.5	3	8

Blanking screw, gasket

- G 1/8 G 1/4 G 3/8 G 1/2 G 3/4 G 1

- FPT-S-RBI



Working pressure min./max.

0 ... 16 bar

Ambient temperature min./max.

-20 ... 80 °C

The delivered product may vary from that in the illustration.

Technical data

Part No.	Port G	Delivery unit
1823462028	G 1/8	25 piece
1823462029	G 1/4	25 piece
1823462030	G 3/8	25 piece
1823462031	G 1/2	25 piece
1823462032	G 3/4	10 piece
1823462033	G 1	5 piece

Technical information

Material

Material	Steel, galvanized
Seal	Polyvinyl chloride, hard

Dimensions

Dimensions

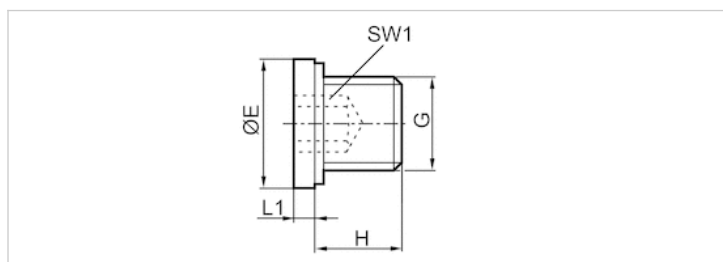

Dimensions

Port G	Ø E	H	L1	SW1
G 1/8	14	8	3	5
G 1/4	18	12	3	6
G 3/8	22	12	3	8
G 1/2	26	14	4	10
G 3/4	32	16	4	12
G 1	39	16	5	17

Efficient pneumatic solutions, our program: cylinders and drives, valves and valve systems, air supply management



Visit us: [Emerson.com/Aventics](https://www.emerson.com/Aventics)

Your local contact: [Emerson.com/contactus](https://www.emerson.com/contactus)



Emerson.com



[Facebook.com/EmersonAutomationSolutions](https://www.facebook.com/EmersonAutomationSolutions)



[LinkedIn.com/company/Emerson-Automation-Solutions](https://www.linkedin.com/company/Emerson-Automation-Solutions)



[Twitter.com/EMR_Automation](https://twitter.com/EMR_Automation)

An example configuration is depicted on the title page. The delivered product may thus vary from that in the illustration. Subject to change. This Document, as well as the data, specifications and other information set forth in it, are the exclusive property of AVENTICS GmbH. It may not be reproduced or given to third parties without its consent. Only use the AVENTICS products shown in industrial applications. Read the product documentation completely and carefully before using the product. Observe the applicable regulations and laws of the respective country. When integrating the product into applications, note the system manufacturer's specifications for safe use of the product. The data specified only serve to describe the product. No statements concerning a certain condition or suitability for a certain application can be derived from our information. The information given does not release the user from the obligation of own judgment and verification. It must be remembered that the products are subject to a natural process of wear and aging.

The Emerson logo is a trademark and service mark of Emerson Electric Co. Brand logotype are registered trademarks of one of the Emerson family of companies. All other marks are the property of their respective owners. © 2017 Emerson Electric Co. All rights reserved.
2019-03



CONSIDER IT SOLVED™