

Klein-Magnete

**ziehend, stossend, Doppel- oder Umkehrhub
für Gleichstrom**

Small Solenoids

**pull or push, double or return operation
DC Solenoids**



ziehend
pull operation



stossend
push operation

Doppel- oder Umkehrhub
double or return operation



GKz-20.03
ziehend
pull operation

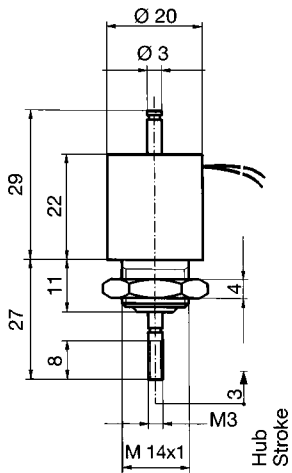

Litzenlänge 300 mm AWG 24
Stranded leads length 300 mm

GKs-20.03
stossend
push operation

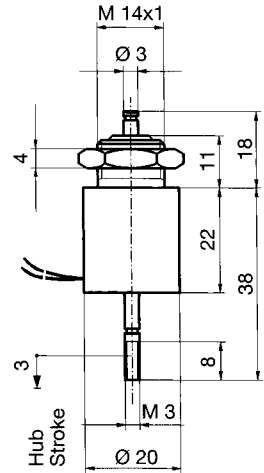

mit Federcharakteristik F ...

Solenoid fitted with return spring to characteristic F ...

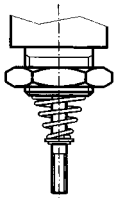

GKz-20.05
ziehend
pull operation

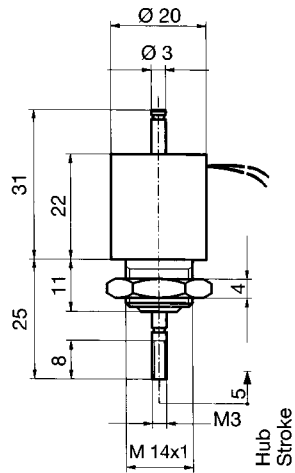

Litzenlänge 300 mm AWG 24
Stranded leads length 300 mm

GKs-20.05
stossend
push operation

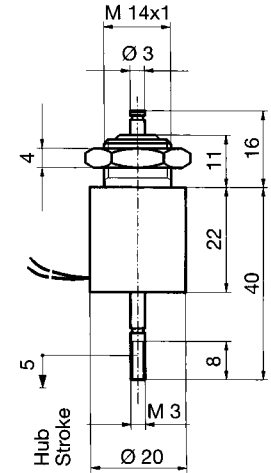

mit Federcharakteristik F ...

Solenoid fitted with return spring to characteristic F ...

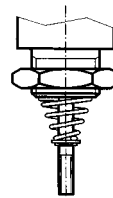

Magnettyp GK-20.03
Solenoid GK-20.03

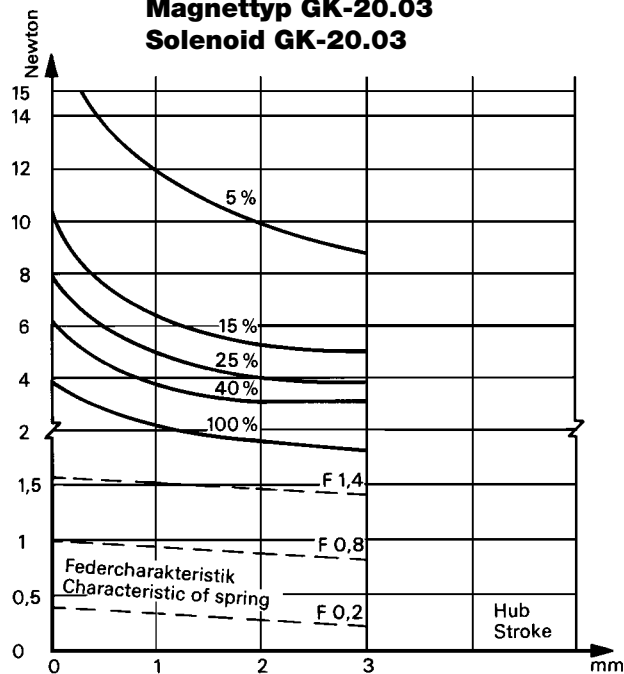

Magnettyp GK-20.05
Solenoid GK-20.05

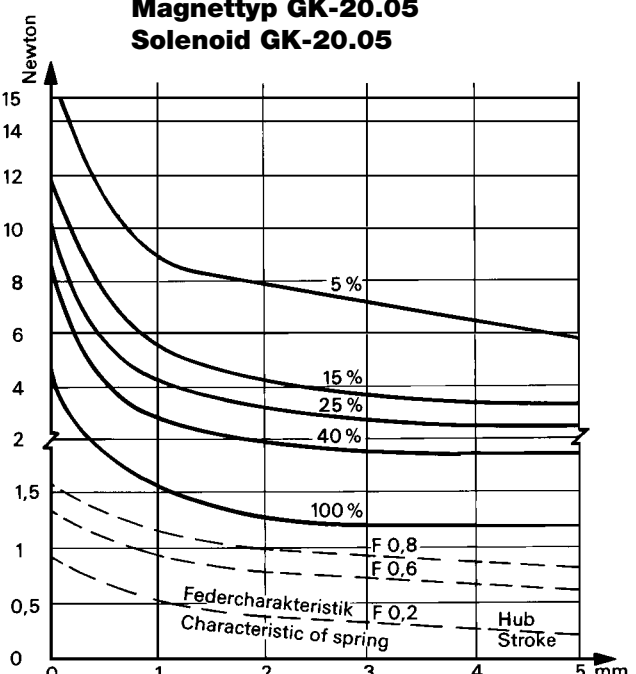

ED %		100	40	25	15	5	Duty cycle %							
Hubarbeit	Ncm	0,55	0,95	1,2	1,5	2,7	100	0,6	1	1,3	1,6	2,9	Work done	Ncm
El. Leistung P ₂₀	W	4	9	14	21	52	40	4	9	14	21	52	Power requirement P ₂₀	W
Anzugszeit	ms	34	32	30	29	26	25	48	40	38	38	36	Operate time	ms
Abfallzeit	ms	30	25	22	20	16	100	38	31	29	28	21	Release time	ms
Magnetgewicht	kg				0,055								Total weight	kg
Ankergewicht	kg				0,007								Plunger weight	kg

GKz-26.04

ziehend
pull operation

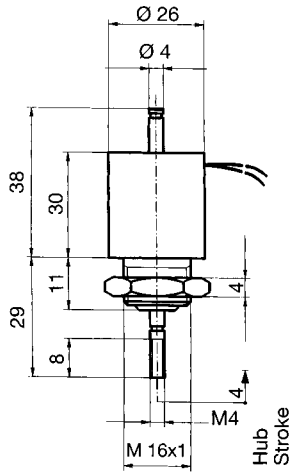

Litzenlänge 300 mm AWG 24
Stranded leads length 300 mm

GKs-26.04

stossend
push operation

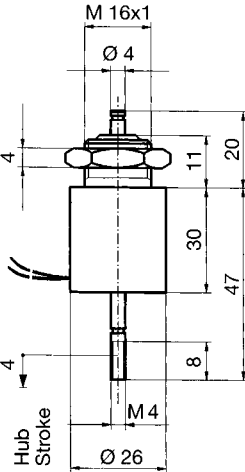

Magnet mit Rückzugsfeder
mit Federcharakteristik F ...

Solenoid fitted with return
spring to characteristic F ...

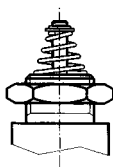
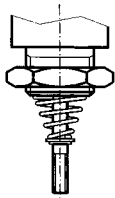

GKz-26.07

ziehend
pull operation

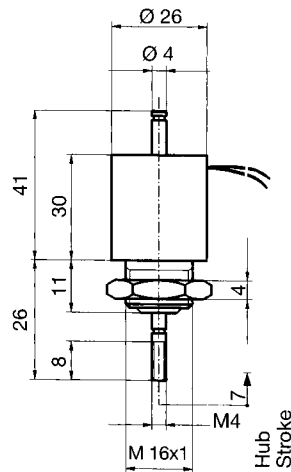

Litzenlänge 300 mm AWG 24
Stranded leads length 300 mm

GKs-26.07

stossend
push operation

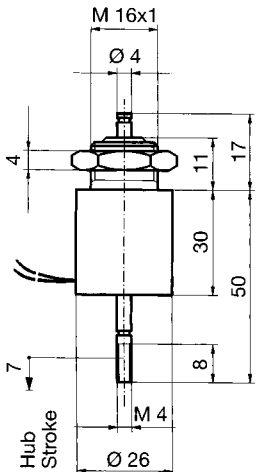

Magnet mit Rückzugsfeder
mit Federcharakteristik F ...

Solenoid fitted with return
spring to characteristic F ...

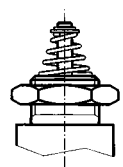
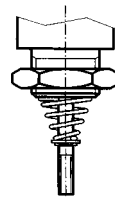

Magnettyp GK-26.04
Solenoid GK-26.04

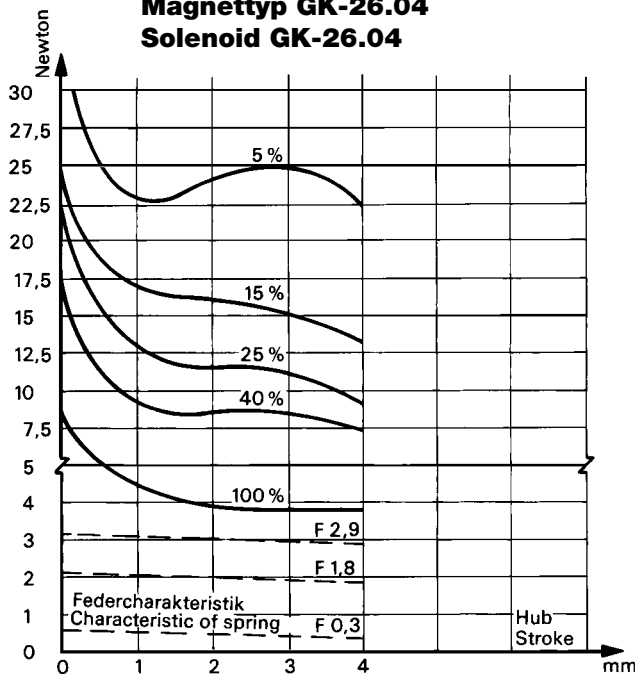

Magnettyp GK-26.07
Solenoid GK-26.07

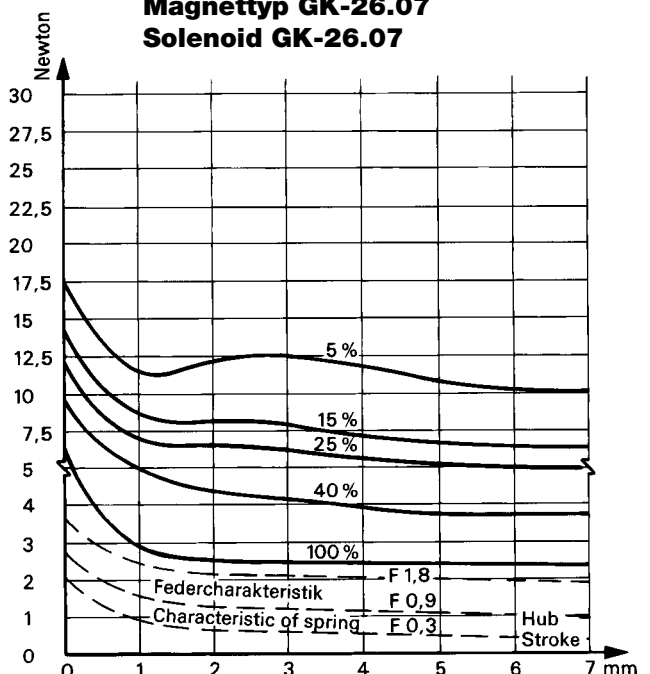

ED %		100	40	25	15	5
Hubarbeit	Ncm	1,5	2,9	3,9	5,3	8,8
El. Leistung P ₂₀	W	6	13	22	30	90
Anzugszeit	ms	55	52	47	45	43
Abfallzeit	ms	34	27	25	24	24
Magnetgewicht	kg	0,095				
Ankergewicht	kg	0,020				

		100	40	25	15	5	Duty cycle %
Hubarbeit	Ncm	1,6	2,6	3,7	4,5	7,7	Work done
El. Leistung P ₂₀	W	6	13	22	30	90	Power requirement P ₂₀
Anzugszeit	ms	70	66	63	61	55	Operate time
Abfallzeit	ms	45	42	40	40	34	Release time
Magnetgewicht	kg	0,095					Total weight
Ankergewicht	kg	0,020					Plunger weight

GKz-32.06
ziehend
pull operation

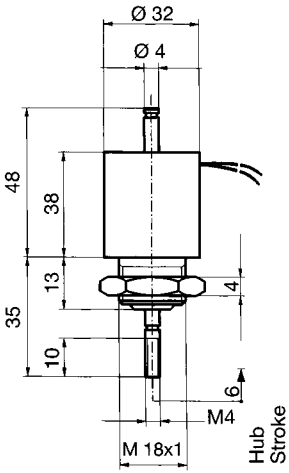

GKs-32.06
stossend
push operation

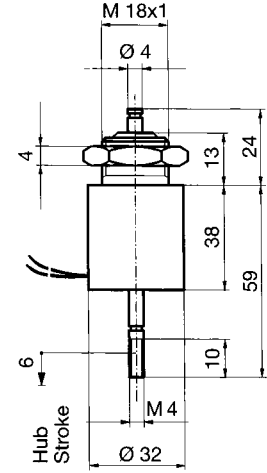

Litzenlänge 300 mm AWG 24
Stranded leads length 300 mm

**Magnet mit Rückzugsfeder
mit Federcharakteristik F ...**

**Solenoid fitted with return
spring to characteristic F ...**

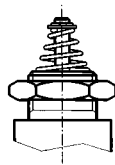
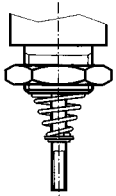

GKz-32.09
ziehend
pull operation

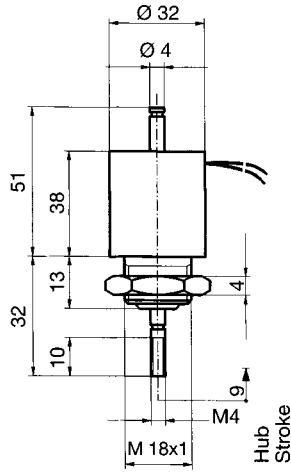

Litzenlänge 300 mm AWG 24
Stranded leads length 300 mm

**Magnet mit Rückzugsfeder
mit Federcharakteristik F ...**

**Solenoid fitted with return
spring to characteristic F ...**

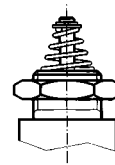
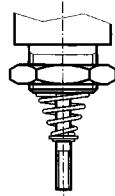

**Magnettyp GK-32.06
Solenoid GK-32.06**

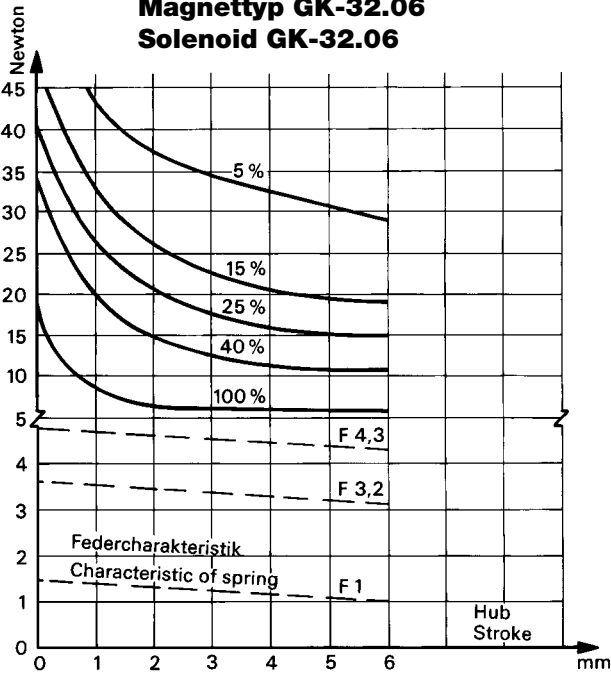

**Magnettyp GK-32.09
Solenoid GK-32.09**

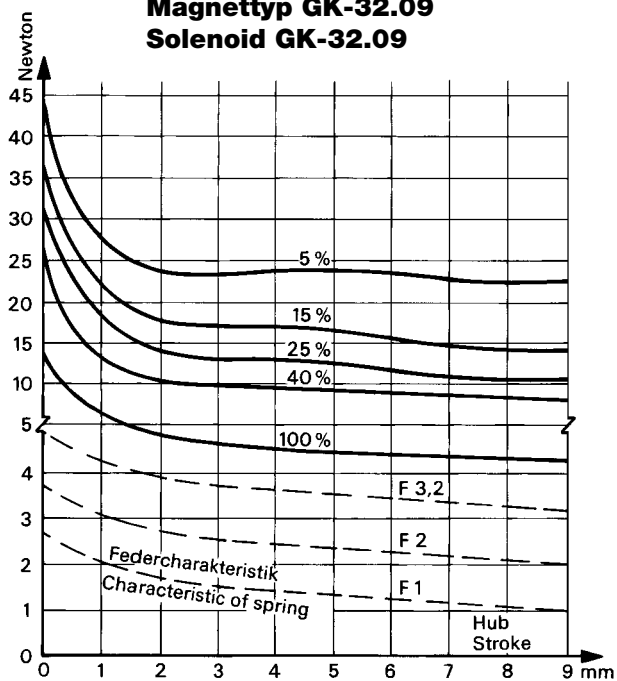

ED %		100	40	25	15	5	Duty cycle %		
Hubarbeit	Ncm	3,5	6,8	9	12	18	Work done	Ncm	
El. Leistung P ₂₀	W	8	25	39	61	120	Power requirement P ₂₀	W	
Anzugszeit	ms	77	68	65	58	57	Operate time	ms	
Abfallzeit	ms	45	42	39	38	37	Release time	ms	
Magnetgewicht	kg			0,180			Total weight	kg	
Ankergewicht	kg			0,030			Plunger weight	kg	

GK-20.03

Doppel- oder Umkehrhub
double or return operation

Ausführung I
Design I

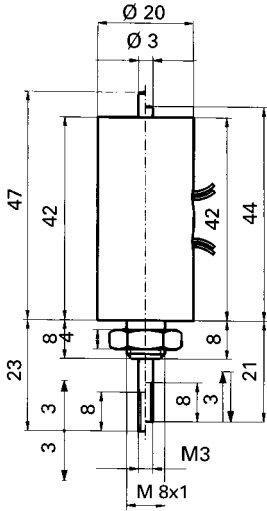

Doppelhub
Double stroke

Umkehrhub
Return stroke

GK-20.03

Ausführung II
Design II

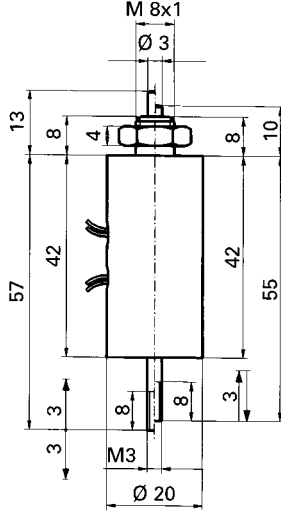

Doppelhub
Double stroke

Umkehrhub
Return stroke

Litzenlänge 300 mm AWG 24
Stranded leads length 300 mm

GK-20.05

Doppel- oder Umkehrhub
double or return operation

Ausführung I
Design I

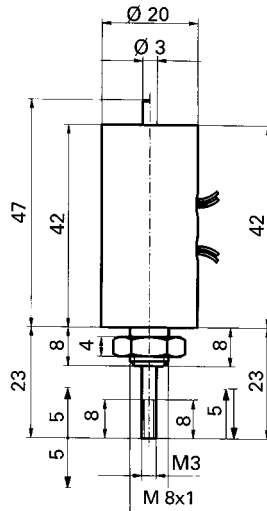

Doppelhub
Double stroke

Umkehrhub
Return stroke

GK-20.05

Ausführung II
Design II

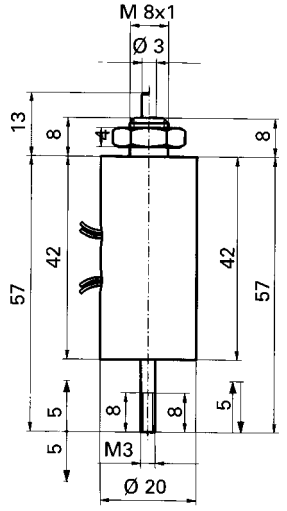

Doppelhub
Double stroke

Umkehrhub
Return stroke

Litzenlänge 300 mm AWG 24
Stranded leads length 300 mm

Magnettyp GK-20.03 Solenoid GK-20.03

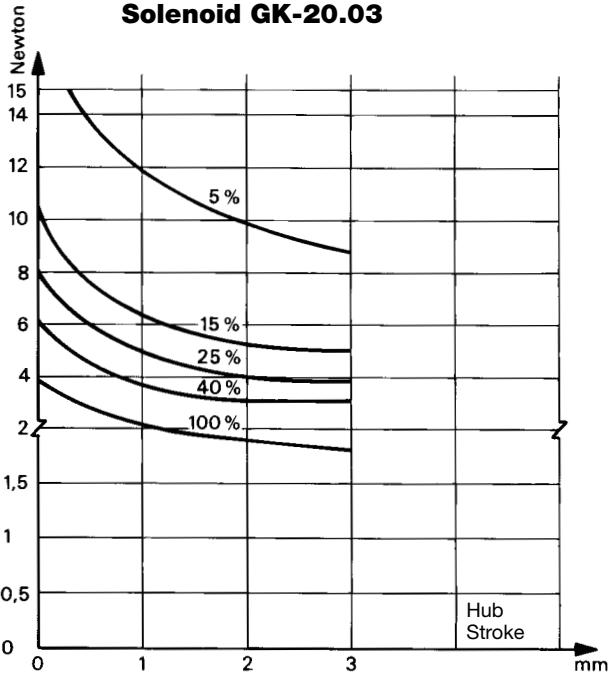

Magnettyp GK-20.05 Solenoid GK-20.05

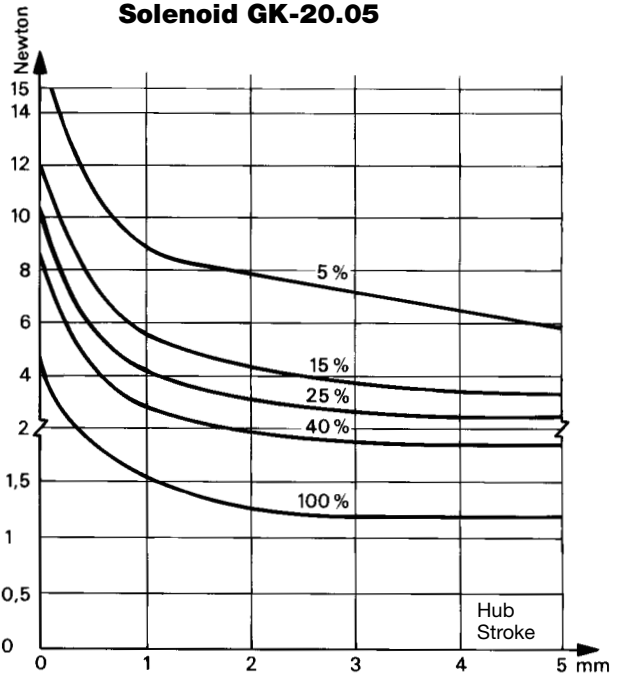

ED %		100	40	25	15	5
Hubarbeit	Ncm	0,55	0,95	1,2	1,5	2,7
El. Leistung P ₂₀	W	4	9	14	21	52
Anzugszeit	ms	34	32	30	29	26
Abfallzeit	ms	30	25	22	20	16
Totalgewicht	kg			0,081		
Anker-Doppelhub	kg			0,011		
Anker-Umkehrhub	kg			0,012		

		100	40	25	15	5	Duty cycle %	
	Ncm	0,6	1	1,3	1,6	2,9	Work done	Ncm
	W	4	9	14	21	52	Power requirement P ₂₀	W
	ms	48	40	38	38	36	Operate time	ms
	ms	38	31	29	28	21	Release time	ms
Total weight	kg			0,081			Total weight	kg
Plunger double stroke	kg			0,011			Plunger double stroke	kg
Plunger return stroke	kg			0,012			Plunger return stroke	kg

GK-26.04

GK-26.04

Doppel- oder Umkehrhub
double or return operation

Ausführung I
Design I

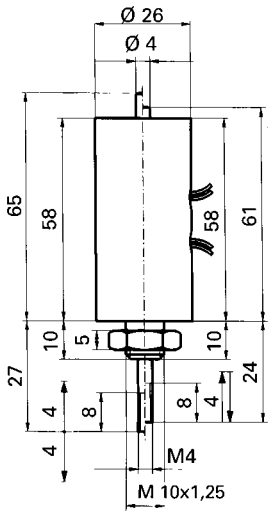

Ausführung II
Design II

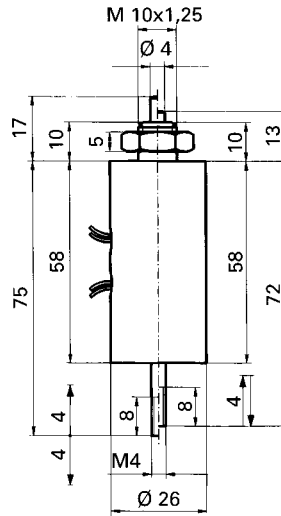

Litzenlänge 300 mm AWG 24
Stranded leads length 300 mm

Litzenlänge 300 mm AWG 24
Stranded leads length 300 mm

Doppelhub
Double stroke

Umkehrhub
Return stroke

Doppelhub
Double stroke

Umkehrhub
Return stroke

GK-26.07

GK-26.07

Doppel- oder Umkehrhub
double or return operation

Ausführung I
Design I

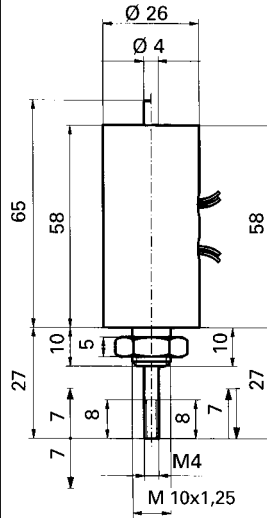

Ausführung II
Design II

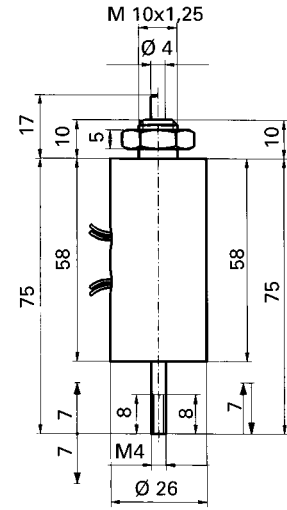

Litzenlänge 300 mm AWG 24
Stranded leads length 300 mm

Doppelhub
Double stroke

Umkehrhub
Return stroke

Doppelhub
Double stroke

Umkehrhub
Return stroke

Magnettyp GK-26.04
Solenoid GK-26.04

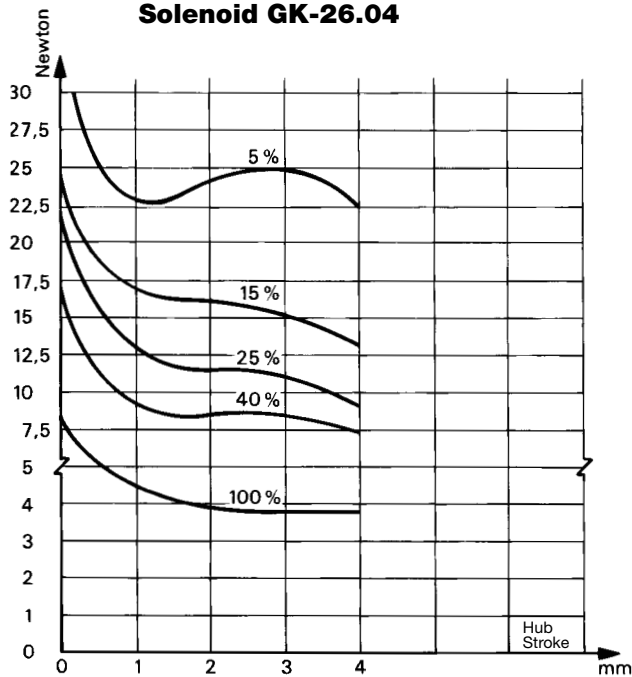

Magnettyp GK-26.07
Solenoid GK-26.07

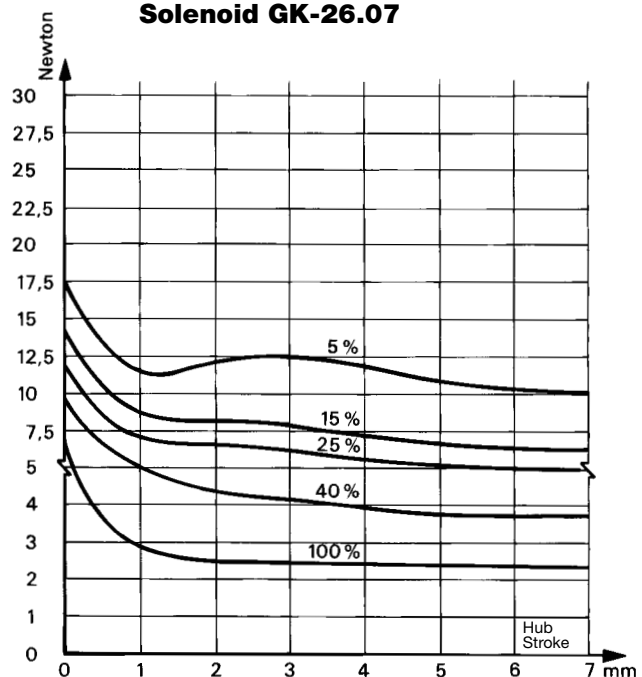

ED %		100	40	25	15	5	Duty cycle %		
Hubarbeit	Ncm	1,5	2,9	3,9	5,3	8,8	Work done	Ncm	
El. Leistung P ₂₀	W	6	13	22	30	90	Power requirement P ₂₀	W	
Anzugszeit	ms	55	52	47	45	43	Operate time	ms	
Abfallzeit	ms	34	27	25	24	24	Release time	ms	
Totalgewicht	kg						0,133	Total weight	kg
Anker-Doppelhub	kg						0,034	Plunger double stroke	kg
Anker-Umkehrhub	kg						0,037	Plunger return stroke	kg

GK-32.06

Doppel- oder Umkehrhub
double or return operation

Ausführung I
Design I

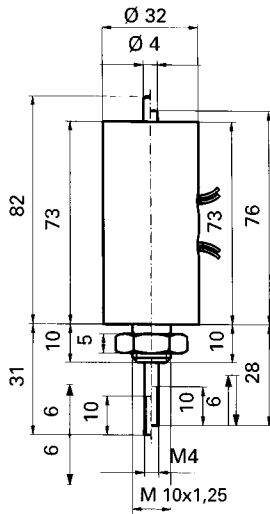

Doppelhub
Double stroke

Umkehrhub
Return stroke

GK-32.06

Ausführung II
Design II

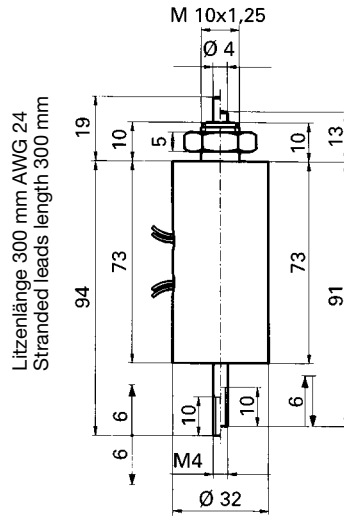

Doppelhub
Double stroke

Umkehrhub
Return stroke

Litzenlänge 300 mm AWG 24
Stranded leads length 300 mm

GK-32.09

Doppel- oder Umkehrhub
double or return operation

Ausführung I
Design I

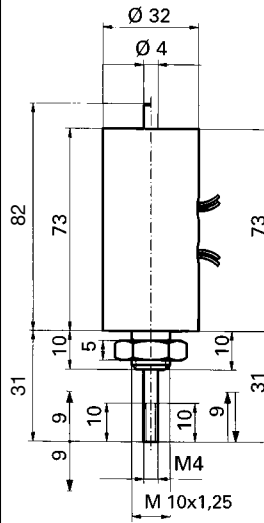

Doppelhub
Double stroke

Umkehrhub
Return stroke

GK-32.09

Ausführung II
Design II

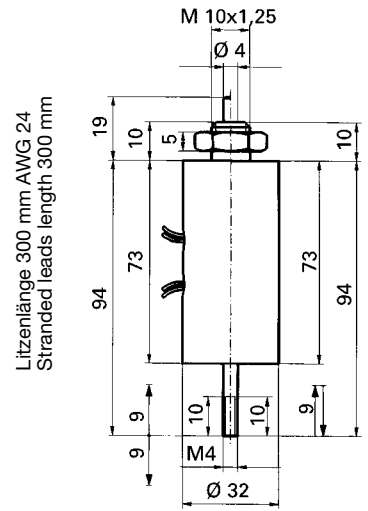

Doppelhub
Double stroke

Umkehrhub
Return stroke

Litzenlänge 300 mm AWG 24
Stranded leads length 300 mm

Magnettyp GK-32.06
Solenoid GK-32.06

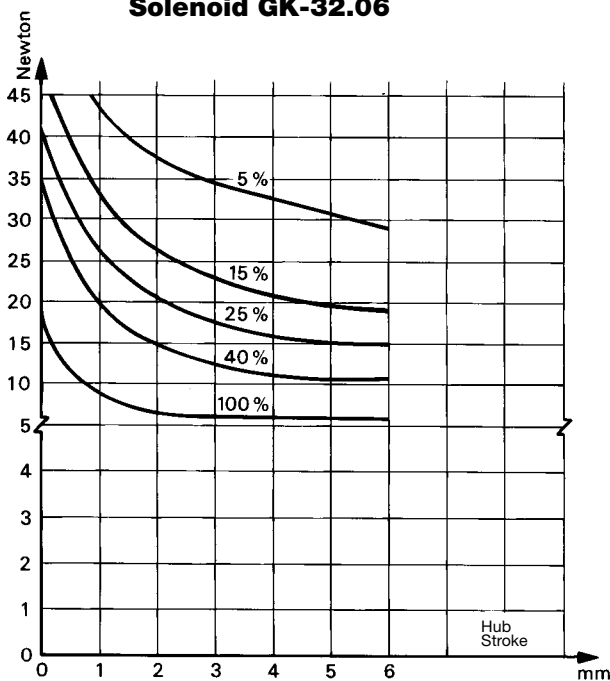

Magnettyp GK-32.09
Solenoid GK-32.09

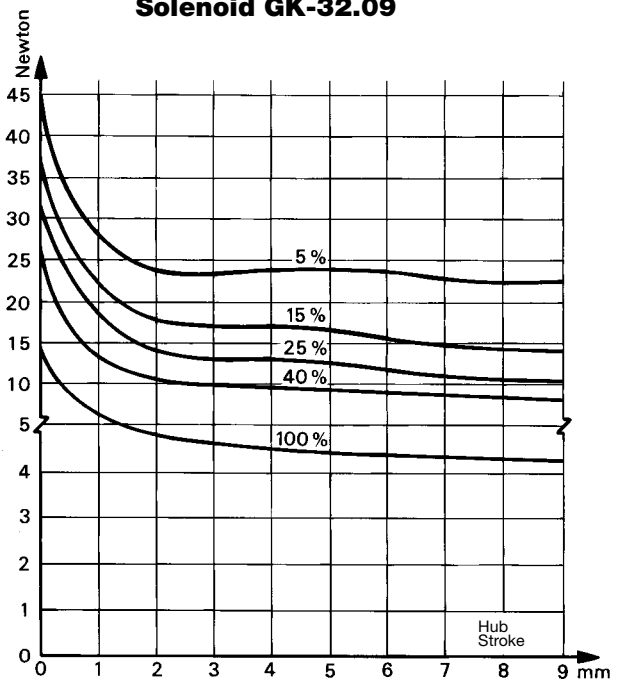

ED %		100	40	25	15	5
Hubarbeit	Ncm	3,5	6,8	9	12	18
El. Leistung P ₂₀	W	8	25	39	61	120
Anzugszeit	ms	77	68	65	58	57
Abfallzeit	ms	45	42	39	38	37
Totalgewicht	kg			0,257		
Anker-Doppelhub	kg			0,046		
Anker-Umkehrhub	kg			0,053		

Duty cycle %		100	40	25	15	5
Work done	Ncm	4	7,4	9,7	13	20
Power requirement P ₂₀	W	8	25	39	61	120
Operate time	ms	90	83	70	65	65
Release time	ms	61	52	50	49	47
Total weight	kg			0,257		
Plunger double stroke	kg			0,046		
Plunger return stroke	kg			0,053		

Erläuterungen

Magnetkraft

Die in den Tabellen angegebenen Kräfte sind bei einer Umgebungstemperatur von 20 °C gemessen und werden bei betriebswarmen Magneten und bei 90 % Nennspannung erreicht. Sie gelten für die Vorzugsspannung 24 VDC. Die Magnetkraftwerte können infolge natürlicher Streuung ±10% von den Tabellenwerten abweichen.

Hub-Kraft-Charakteristik

Die Hub-Kraft-Charakteristiken sind in den Grafiken für jede Baugröße und jede normierte Einschaltdauer dargestellt.

Anzugs- und Abfallzeiten

Die Werte für die Anzugs- und Abfallzeiten sind Richtwerte und gelten für Nennspannung, betriebswarmen Zustand, bei Belastung mit 70 % der in den Tabellen angegebenen Magnetkraft und gleichstromseitig geschaltet über einen Quecksilberschalter.

Vorzugs-Nennspannung

ISLIKER-Magnete haben eine Vorzugs-Nennspannung von 24 VDC. Andere Nennspannungen bis max. 48 VDC auf Wunsch möglich.

Einschaltdauer

Die Spieldauer für die Berechnung der Einschaltdauer beträgt 30 s.

El. Anschlussart

Mit Litzenanschluss AWG 24 (300 mm) nach UL-1569

Lagerung des Magnetankers

Die Magnete sind mit wartungsfreien PTFE-Lagern ausgerüstet.

Oberflächenbehandlung der Magnete

Oberfläche nitrocarburisiert, rostbeständig.

Isolierstoffklasse

F (155 °C) nach VDE 0580

Schutzart

IP 20 DIN 40 050/1

Montagehinweise

Seitliche Kräfte auf den Anker sind zu vermeiden, da durch die dabei entstehenden Reibungskräfte die Lebensdauer und die Funktion beeinträchtigt werden könnten.

Sonderausführungen

Sonderausführungen sind lieferbar. Wenn Sie das Gewünschte nicht finden, bitten wir um Rückfrage.

Funktionsbeschreibung

Umkehrhub

Der Umkehrhub-Kleinmagnet ist mit zwei Spulen ausgerüstet. Sein Anker kann zwei verschiedene Positionen einnehmen. Je nach Spule, die eingeschaltet wird, bewegt sich der Anker in die eine oder andere Endlage.

Doppelhub

Der Doppelhub-Kleinmagnet ist mit zwei Spulen ausgerüstet. Sein Anker kann drei verschiedene Positionen einnehmen. Je nach Spule, die eingeschaltet wird, bewegt sich der Anker von der Mittellage in die eine oder andere Endlage. Dieser muss nach dem Ausschalten mechanisch (mittels Feder) in die Mittellage zurückgestellt werden.

General

Force of the solenoid

The forces indicated in the performance data are measured at an ambient temperature of 20 °C with the solenoid functioning at its normal operating temperature, with 90 % of its rated voltage. They apply to the preferred rated voltage of 24 VDC. The values shown in the diagrams can differ ±10% as a result of natural dispersion.

Force/stroke characteristics

The force/stroke characteristics are represented in the graphs for the various solenoid sizes and the standard duty cycles.

Operate and release times

Operate and release times are standard time data, apply to the preferred rated voltage, are measured with a load equal to 70 % of the values shown in the diagrams and have been switched on d.c. side with a wet reed relay.

Preferred rated voltage

ISLIKER-solenoids have a preferred rated voltage of 24 VDC. Other rated voltages up to 48 VDC can be delivered.

Duty cycle

The max. cycle time to determine the duty cycle is 30 sec.

Electrical terminations

Stranded leads AWG 24 (300 mm) UL-1569

The magnetic plunger bush bearing

The plunger is supported in place by PTFE-bushings.

Protective finish of the solenoids

Solenoid housing nitrocarburized, rust-resistant.

Insulation class

F (155 °C) to VDE 0580

Protection classification

IP 20 DIN 40 050/1

Mounting instructions

Side forces on the plunger should be avoided, as this could cause undue frictional forces which may effect the solenoid function and life-time expectancy.

Special models

Special types of solenoid are possible. Should you not find a solenoid which performs your specific application, please contact us.

Description

Return operation

The return operation small solenoid is manufactured with two coils. The plunger can presume two different positions. The end position of the plunger is determined by the coil being energized.

GKu-26.07

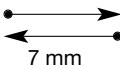

Double operation

The double operation small solenoid is manufactured with two coils. The plunger can presume three different positions. The plunger moves in one direction or the other from the middle position depending on which coil is energized. The plunger must be returned to its central position by a mechanical means, i. e. a spring.

GKd-26.07



Bestelltext

Zug- oder Stossmagnet

Gleichstrom-Klein-Magnet

z: ziehend

s: stossend

d: Doppelhub

u: Umkehrhub

Durchmesser des Magneten in mm

Aktiver Hub des Magneten in mm

Einschaltdauer in %

Doppel- oder Umkehrhubmagnet

Einschaltdauer in %

Wellenende stossend

Einschaltdauer in %

Wellenende ziehend

W: mit Litzenanschluss

Spannung in Volt

Mit Rückzugsfeder

Ohne Rückzugsfeder kein Index

Index der Federkennlinie

Ausführung I oder II

Doppel- oder Umkehrhubmagnet

GKz - 26.04 - 100 W - 24 F 1,8

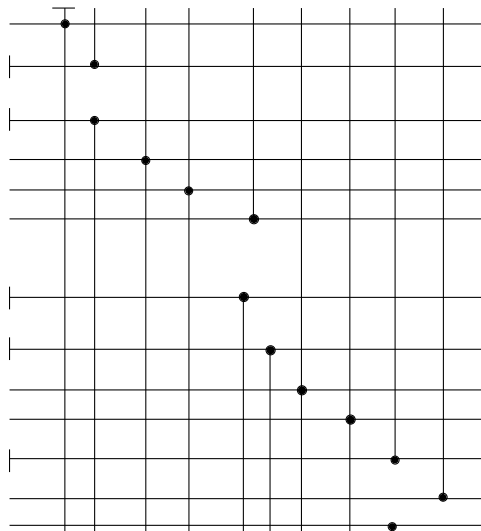

GKu - 26.04 - 5/5 W - 24 I

Ordering specification

pull or push solenoid

Type **GK**: D. C. small solenoid

z: pull operation

s: push operation

d: double operation

u: return operation

Diameter of solenoid in mm

Active stroke of solenoid in mm

Duty cycle in %

Double or Return Stroke Solenoid

duty cycle in %

push action

duty cycle in %

pull action

W: stranded leads

Voltage

with return-spring assembly

without spring - No index

Index of return-spring

Design I or II

Double or Return Solenoid