

SANMOTION

STEPPING SYSTEMS

F2

2-Phase Stepping Systems

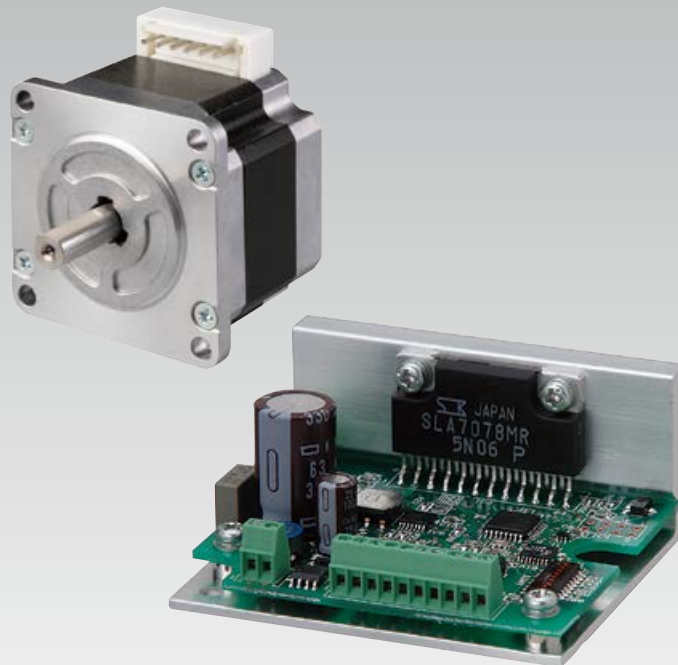

SANYO DENKI

Ver.9



SANMOTION

2-PHASE STEPPING SYSTEMS

F2



DC Input Set Orders



DC Input Stepping Drivers



Stepping Motors

Stepping Motors, IP65-Rated Stepping Motors,
In-Vacuum Stepping Motors, Synchronous Motors

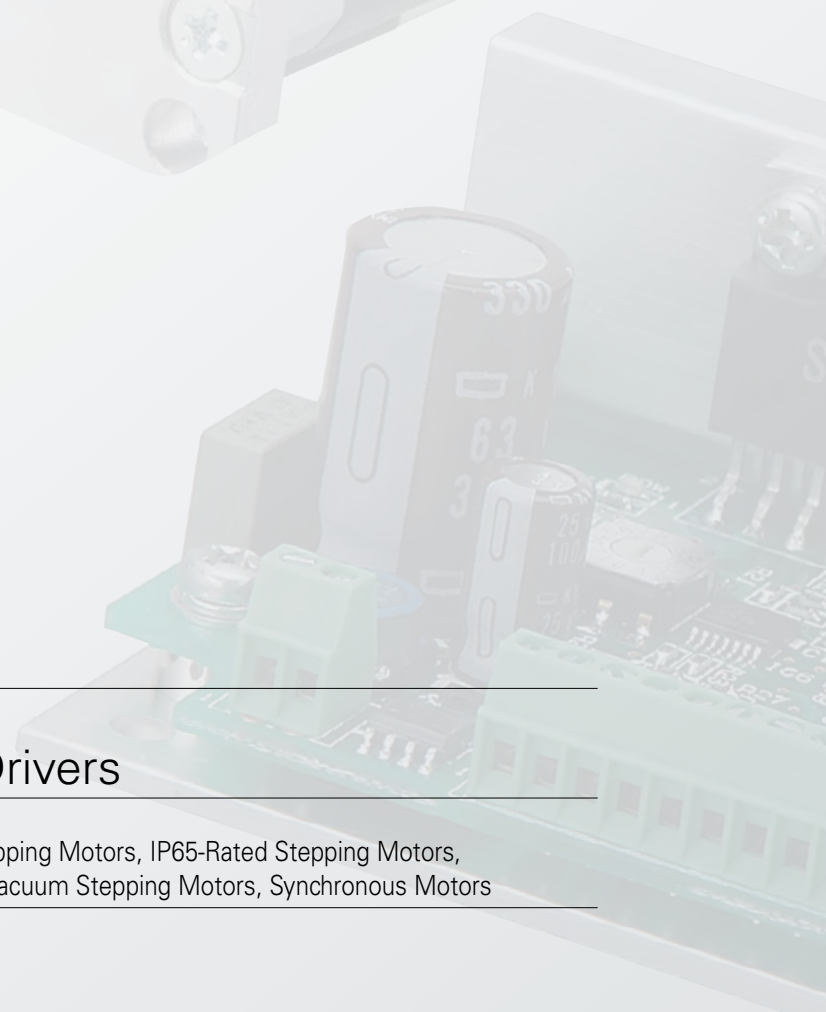

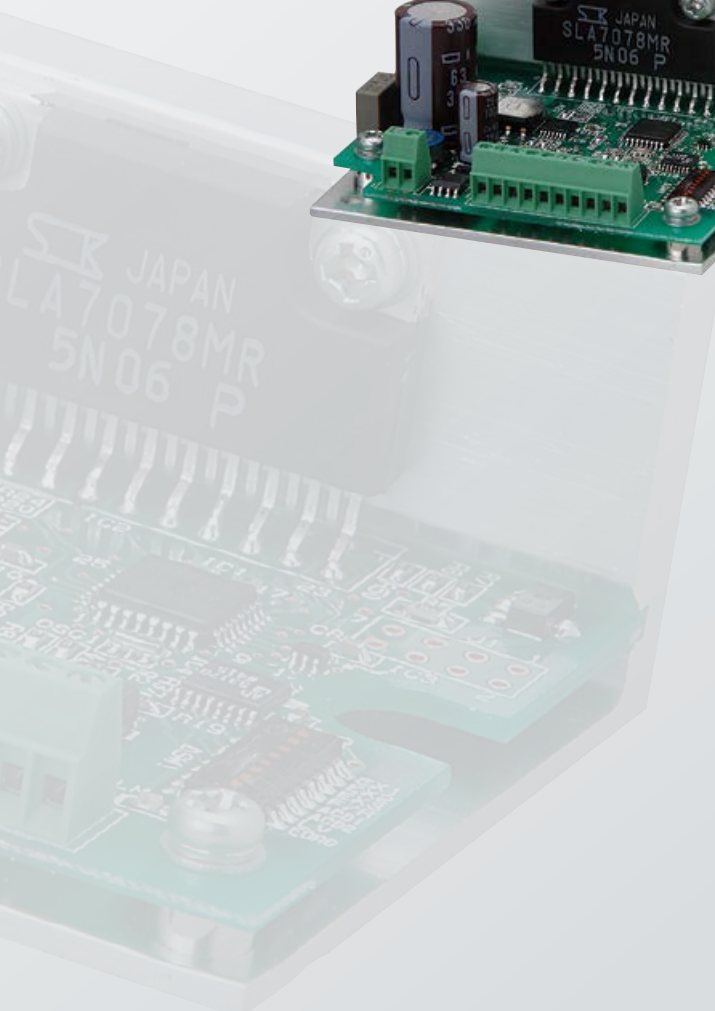
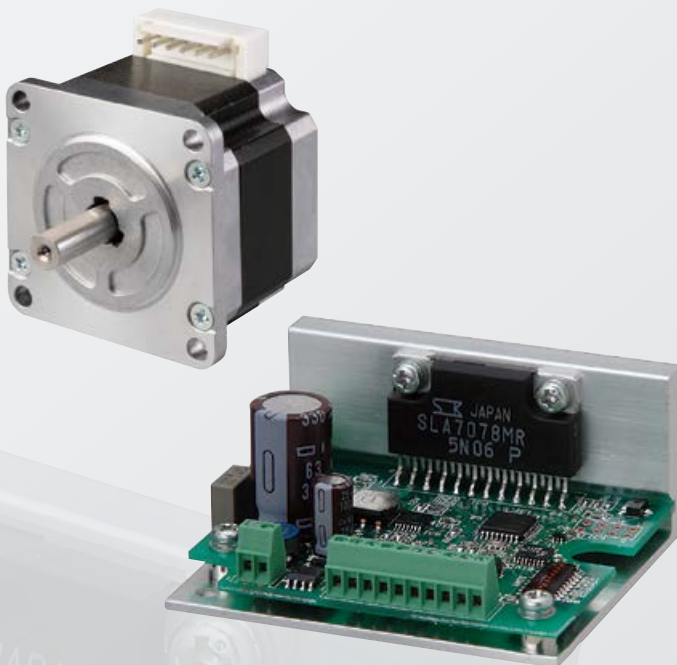

Contents

Application Examples	p. 4
Lineup	p. 6
Lineup Details	p. 7

Set Orders

DC Input Set Orders	p. 10
System Configuration Diagram	p. 10
How to Read Set Order Numbers	p. 11
Items Included in a Set	p. 12
Unipolar Motor Specifications	p. 13
Bipolar Motor Specifications	p. 17
Stepping Motor Dimensions	p. 22
General Specifications of Stepping Motors	p. 24
Driver Dimensions	p. 26
Driver Specifications	p. 26
Driver Part Names and Functions	p. 27
Connections and Signals	p. 28

Stepping Motors (Single Items)

Stepping Motors	p. 36
IP65-Rated Stepping Motors	p. 72
In-Vacuum Stepping Motors	p. 77
Synchronous Motors	p. 77
Models No Longer Listed and Their Replacing Models	p. 78
Safety Precautions	p. 80

Easy positioning control

by simple encoder-less stepping systems



Stepping motors rotate precisely at a fixed angle (step angle) with each pulse the driver receives from a pulse generator.

SANMOTION F2 motors typically have a full step angle of 1.8°.

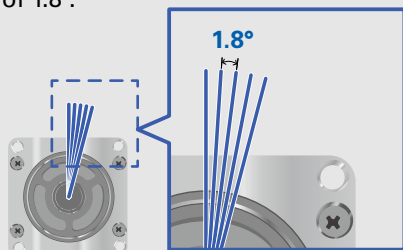

Full step angle
1.8°

200 steps

These use open-loop control without an encoder (position detection sensor), helping build simple and low-cost systems. Ease of use is a key point.

In addition, they use holding force when stopped, and feature stable stopping without micro vibrations.



Application Examples

The SANMOTION F2 can be used in a wide variety of applications, including fixed-speed drive synchronized with command pulses, accurate positioning, and stable stopping.



ATM



Blood analyzer



Wafer cleaning equipment

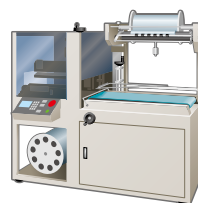

Food packaging equipment

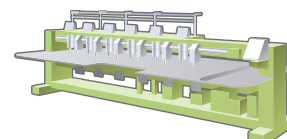

Embroidery machine

We hereby declare that the products listed in the catalog comply with the threshold values listed in Annex II, Directive (EU) 2015/863, which is an amendment to Directive 2011/65/EU of the European Parliament and of the Council of June 8, 2011 on the restriction of the use of certain hazardous substances (RoHS) in electrical and electronic equipment. However, the applications listed in ANNEX III of RoHS Directive 2011/65/EU are exempted from the restriction. Also, all models of SANMOTION F2 drivers conform to CE/EN and UL as standard.



Application Examples

Blood analyzer

For rotating the specimen tray and rotary table

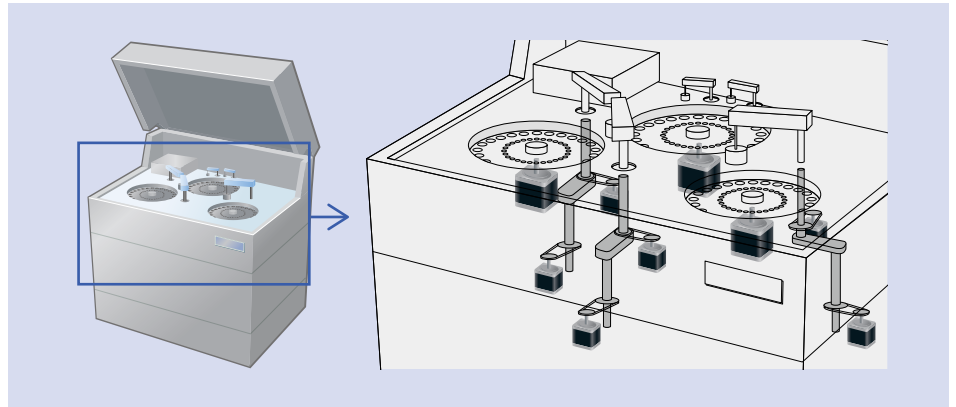

Ophthalmology inspection equipment

For moving the camera vertically and horizontally

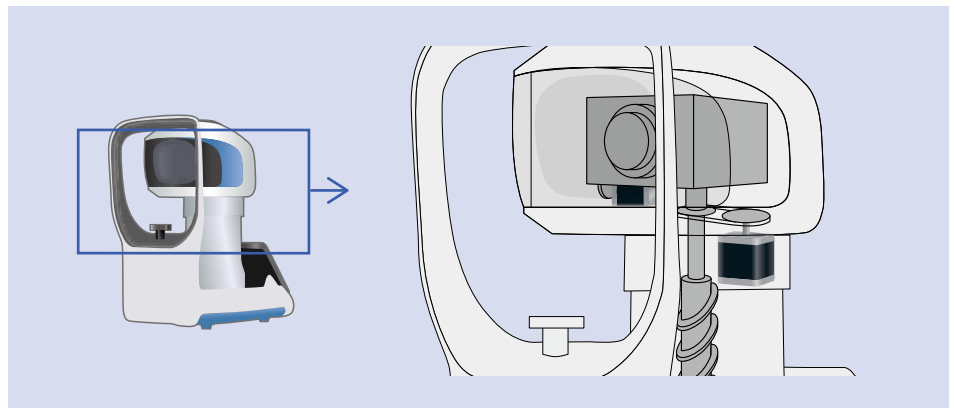

Belt conveyor

For driving the belt and rollers

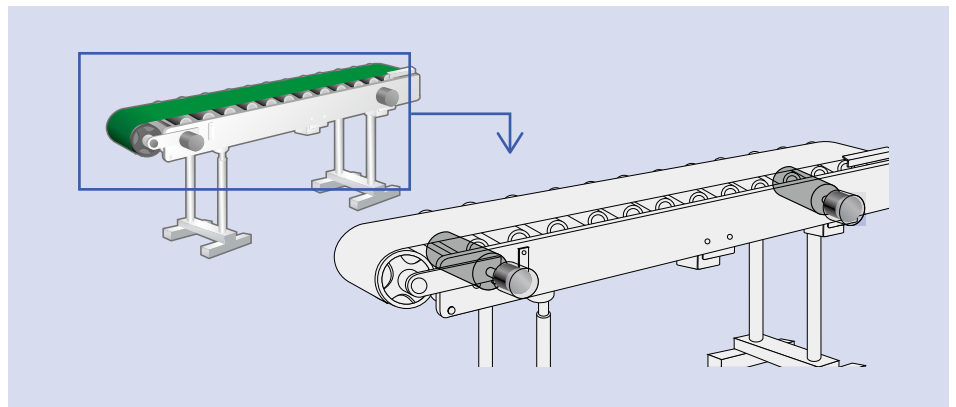

Filling machine

For filling liquids and pastes

With an induction motor

As the motor speed is affected by the viscosity of the filling material, the number of rotations must be adjusted by an inverter. Startup time is also slow.

The diagram shows two filling stations. The first station is labeled 'High viscosity' and shows 'Under-filling'. The second station is labeled 'Low viscosity' and shows 'Over-filling'. Below each station is a 'Speed vs. Time' graph. The 'Actual operation' (blue line) shows a slow ramp-up to a lower speed for high viscosity and a slow ramp-down for low viscosity, compared to the 'Ideal operation' (orange line) which is a sharp step function.

With a stepping motor

Stepping motors can stably dispense a constant amount because they simply rotate at a fixed angle regardless of the viscosity of the material. Startup time is also short.

The diagram shows two filling stations. Both stations show a 'Constant filling amount'. Below each station is a 'Speed vs. Time' graph. The 'Actual operation' (blue line) shows a very sharp, vertical ramp-up and ramp-down, matching the 'Ideal operation' (orange line) which is a sharp step function.

— Ideal operation
— Actual operation

Lineup

Set Orders ▶ p. 8-

DC Input

Unipolar

We offer orders of a unipolar stepping motor and a DC stepping driver as a set.

Input voltage:
24/36 VDC

Motor size:
28 mm sq., 42 mm sq., 56 mm sq.



Bipolar

We offer orders of a bipolar stepping motor and a DC stepping driver as a set.

Input voltage:
24/36 VDC

Motor size:
28 mm sq., 42 mm sq., 50 mm sq., 56 mm sq., 60 mm sq.



The unipolar drive allows current to flow in a single direction along the winding. The drive circuit is simpler than that of the bipolar drive. The bipolar drive allows current to flow in both directions along the winding. The drive circuit is more complex, but it offers higher torque.

Stepping Motors (Single Items) ▶ p. 31-

Stepping Motors ▶ p. 36-

These stepping motors feature high torque. Select from among a broad lineup of products from an ultra-compact 14 mm sq. sized motor to a thin-profile motor with a 11.4 mm motor length.

Consult us regarding customization. ▶ p. 34
A driver is required separately.

Motor size:
14 mm sq., 28 mm sq., 35 mm sq., 42 mm sq., 50 mm sq.,
56 mm sq., 60 mm sq., 86 mm sq., ø106 mm



IP65-Rated Stepping Motors Water and dust protection ▶ p. 72-

These IP65-rated motors* have superior water and dust resistance, and can be safely used in water-exposed environments such as in food processing machines.

* Except for the shaft and cable ends.

A driver is required separately.

Motor size:
56 mm sq., 86 mm sq.



In-Vacuum Stepping Motors Custom product ▶ p. 77

We can customize motors for use in low to ultra-high vacuum environments to suit your system requirements.

A driver is required separately.



Synchronous Motors Custom product ▶ p. 77

Synchronous motors rotate at a constant speed in sync with the AC power frequency. Since they can be driven with AC power directly, a driver is not necessary.



Lineup Details

Set Orders ▶ p. 8-

Series	DC input set orders Unipolar	DC input set orders Bipolar
Input voltage	24/36 VDC	24/36 VDC
Microsteps	1, 2, 4, 8, 16	1, 2, 4, 8, 16
Step angle	1.8° full step angle motors	1.8° to 0.1125° /pulse
	0.9° full step angle motors	0.9° to 0.05625° /pulse
Motor size	28 mm sq., 42 mm sq., 56 mm sq.	28 mm sq., 42 mm sq., 50 mm sq., 56 mm sq., 60 mm sq.
Items included in a set	A driver, motor, and motor cable with connectors (Supplied only with connector-type motors)	A driver, motor, and motor cable with connectors (Supplied only with connector-type motors)
Page	p.10 to 29	

Stepping Motors (Single Items) ▶ p. 31-

Stepping Motors ▶ p. 36-

Full step angle	Motor size	Holding torque [N·m]	Model no.	Page
				Specifications/Characteristics/ Dimensions
0.9°	42 mm sq.	0.2 to 0.48	SH142□-□□□1	p. 41 to 42
0.9°	60 mm sq.	0.57 to 2.15	SH160□-□□□0	p. 56 to 57
1.8°	14 mm sq. Ultra-compact	0.0065 to 0.01	SH214□-5□□1	p. 36
1.8°	28 mm sq.	0.055 to 0.145	SH228□-5□□1	p. 37 to 38
1.8°	35 mm sq.	0.12 to 0.32	SH35□□-1□□□0	p. 39 to 40
1.8°	42 mm sq. Thin-profile	0.083 to 0.186	SS242□-50□□□	p. 43
1.8°	42 mm sq.	0.22 to 0.8	SF242□-1□□□1	p. 44 to 45
1.8°	50 mm sq.	0.28 to 0.53	103H670□-□□□0	p. 46 to 48
1.8°	50 mm sq. Thin-profile	0.1 to 0.215	SS250□-80□□0	p. 49
1.8°	56 mm sq. (UL models)	0.53 to 2.5	SM256□C□0□□1	p. 50 to 55
1.8°	60 mm sq. *	It is recommended you use a 56 mm sq. motor (SM256□C□0□□1)		p. 55
1.8°	86 mm sq.	2.5 to 9	SH286□-□□□1	p. 58 to 61
1.8°	∅106 mm	10.8 to 19	103H8922□-□□□1	p. 62
1.8°	56 mm sq. (CE models)	0.39 to 1.27	103H712□-6□□0	p. 63
1.8°	86 mm sq. (CE/UL models)	2.5 to 9	SM286□-□□□□	p. 64 to 67
1.8°	∅106 mm (CE models)	13.2 to 19	103H8922□-63□1	p. 68

Note: We provide motor customization services such as motors with an encoder, gear, and brake. For more information, see respective specifications and characteristics pages.

* For 60 mm sq. size: It is recommended you use a 56 mm sq. motor (SM256□C□0□□1) that has equivalent torque as a conventional motor (103H782) with a smaller size. We also offer customization that makes the flange compatible with 60 mm sq. motors for easy replacement.

IP65-Rated Stepping Motors **Water and dust protection** ▶ p. 72-

Full step angle	Motor size	Holding torque [N·m]	Safety standards	Model no.	Page
					Specifications/Characteristics/ Dimensions
1.8°	56 mm sq.	1 to 1.7	CE and UL	SP256□-5□□0	p. 73 to 74
1.8°	86 mm sq.	3.3 to 9	CE and UL	SP286□-5□□0	p. 75 to 76

In-Vacuum Stepping Motors **Custom product** ▶ p. 77

Motor size
42 mm sq. to ∅106 mm

Synchronous Motors **Custom product** ▶ p. 77

Motor size
56 mm sq. to ∅106 mm

Set Orders

Features

Low vibration

Thanks to their low vibration mode, SANMOTION F2 stepping drivers can smoothly operate stepping motors even at low resolution settings such as full-step and half-step modes. Vibrations can be suppressed regardless of the host controller.

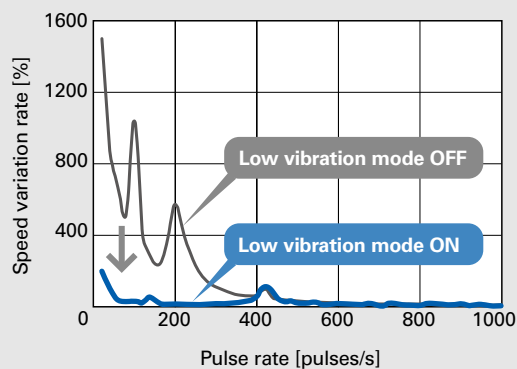

Microstepping drive

Resolution settings up to 16 subdivisions of the full step angle can be used, enabling smooth equipment operation with low vibration.

How to Read Specifications

Unipolar DC input driver (model: US1D200P10) and stepping motor

RoHS

		28 mm sq. (1.8° full step angle)		42 mm sq. (1.8° full step angle)	
		32 mm	51.5 mm	33 mm	39 mm
2 Size	Motor size				
	Motor length				
3 Single shaft	Set order no.	DU14S281S	DU14S285S	DU15S421S	DU15S422S
	Motor model no.	SH2281-5271	SH2285-5271	SF2421-12U41	SF2422-12U41
3 Dual shaft	Set order no.	DU14S281D	DU14S285D	DU15S421D	DU15S422D
	Motor model no.	SH2281-5231	SH2285-5231	SF2421-12U11	SF2422-12U11
4 Holding torque	N·m	0.055	0.115	0.22	0.33
5 Rotor inertia	×10 ⁻⁴ kg·m ²	0.01	0.022	0.031	0.046
6 Rated current	A/phase	1	1	1.2	1.2
7 Motor mass ⁽¹⁾	kg	0.11	0.2	0.23	0.3
8 Allowable thrust load	N	3	3	10	10
9 Allowable radial load ⁽²⁾	N	42	49	39	37

(1) For the driver mass, see p. 26 (2) Load is exerted to the shaft end.

10 Characteristics

With rubber coupling used

Pull-out torque Full step — Half step — fs: Maximum starting pulse rate with no load Full step ● Half step ●
Input current (with no load) Full step - - - Half step - - - Input current (with load) Full step ● Half step ●

DU14S281S
DU14S281D

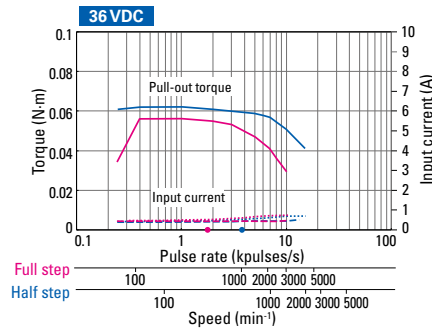
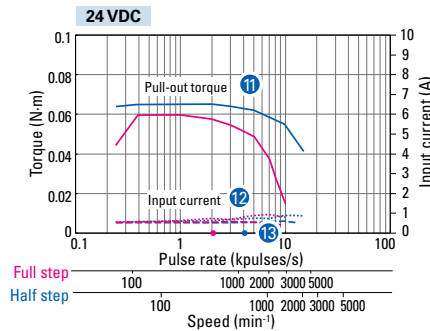

- Model number of the driver included in the set.
- Flange size and length of the stepping motor included in the set. The full step angle is the angle at which the motor rotates with each pulse in full step mode. In half step mode, the motor rotates by a half the full step angle with each pulse.
- The set order number and the model number of the stepping motor included in the set. The model number varies depending on whether the motor's shaft is single shaft or dual shaft.
- This is the maximum torque that is generated when the stepping motor is rotated by exerting an external force on the shaft at 2-phase excitation at the rated current.
- This is the moment of inertia of the rotor.
- This is the rated current that flows to the motor winding.
- This is the mass of the stepping motor.
- This is the maximum allowable load to the shaft in the axial direction. Take care not to exceed this limit.
- This is the maximum allowable load to the shaft in the direction perpendicular to the axial direction. Take care not to exceed this limit.
- This graph shows the relationship between the pulse rate (frequency), motor speed, and torque. The driver's input current is shown in addition to the torque. Characteristics in full step mode is shown in red, and in half step mode is shown in blue.
- The pull-out torque is the maximum torque in which synchronized operation with command pulses can be maintained. If a torque that exceeds this value is applied to the stepping motor, it will be unable to syn-

chronize with command pulses. Thus, when selecting a motor, you should allow for a torque margin of 1.4 to 2 times, in order to avoid step-out.

- This graph shows the current value of the power supply powering the driver.

— — — — — The red and blue dashed lines show the source current value when there is no load (motor by itself).

● ● ● ● ● The red and blue dotted lines show the source current value when the maximum torque is applied to the stepping motor (with a load).

The required power supply capacity (W) is calculated from this graph.

- The red- and blue-colored dots in the lower part of the graph show the upper limit for the maximum starting pulse rate (fs) of the stepping motor by itself (with no load). Values in full step mode is shown in red, and in half step mode is shown in blue. The stepping motor will not operate normally if it is started using pulse rates that exceed these values. For this reason, it is necessary to start the stepping motor using pulse rates that are lower than these values. The maximum starting pulse rate with loads (f_L) can be determined using the expression below.

$$f_L = \frac{f_s}{\sqrt{1 + \frac{J_L}{J_M}}}$$

J_M: Rotor inertia
J_L: Load inertia
f_s: Maximum starting pulse rate with no load

DC Input Set Orders

Unipolar/Bipolar

Items included in a set...▶p. 12 Specifications/Characteristics...▶p. 13 to 21
 Motor dimensions...▶p. 22 to 23 Motor specifications...▶p. 24
 Driver dimensions...▶p. 26 Driver specifications...▶p. 26

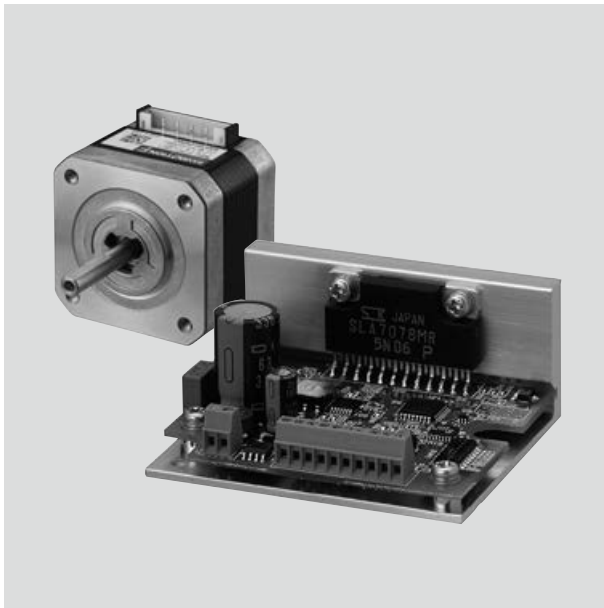



Items included in a set **RoHS**

Driver Terminal block type    

Unipolar Model no.: US1D200P10 Input voltage: 24/36 VDC

Bipolar Model no.: BS1D200P10 Input voltage: 24/36 VDC

- The Instruction Manual is available for download from our website.
 - Drivers are available for separate purchase.
- Connector-type drivers are also available. Contact us for details.

Motor   (Only for 56 mm sq. motors)

Unipolar motor sizes: 28 mm sq., 42 mm sq., 56 mm sq.

Bipolar motor sizes: 28 mm sq., 42 mm sq., 50 mm sq.,
56 mm sq., 60 mm sq.

Cable with connectors

Supplied only with connector-type motors

System Configuration

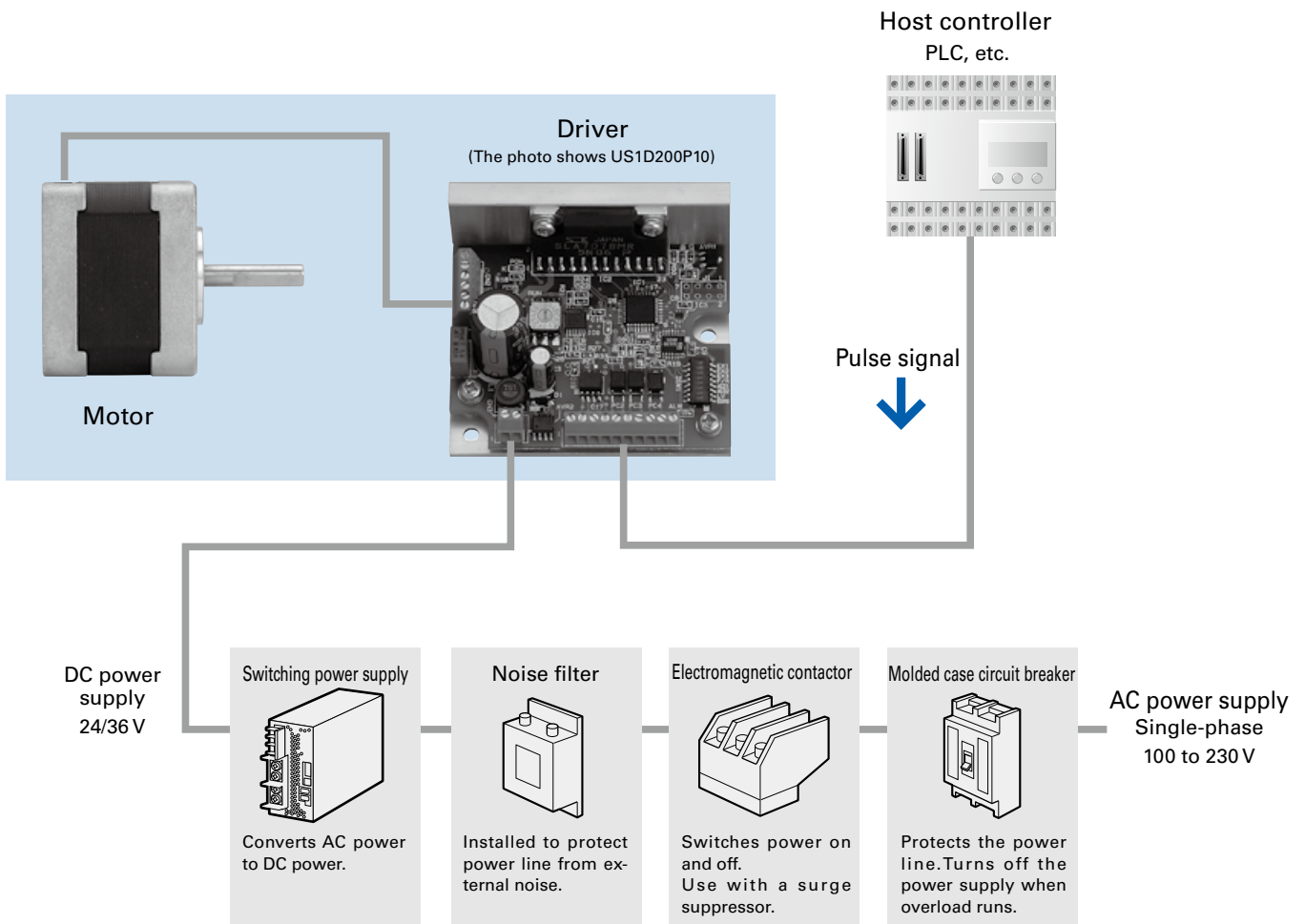

How to Read Set Order Numbers

Note that not all possible parameter combinations are valid. Contact us or see Items Included in a Set on the next page for details of the items included in individual sets.

e.g., The model number shown below is a set of a DC input driver (US1D200P10) and a motor (SM2561C20U41). The motor's specifications are: 56 mm sq. size, 41.8 mm length, and single shaft.

D U 1 6 M 71 1 S

Stepping motor shaft
S: Single shaft, D: Dual shaft

Stepping motor length

Motor size												
Name	28 mm sq.		42 mm sq.				50 mm sq.		56 mm sq.		60 mm sq.	
	Motor model no.	Motor length [mm]	Motor model no.	Motor length [mm]	Motor model no.	Motor length [mm]	Motor model no.	Motor length [mm]	Motor model no.	Motor length [mm]	Motor model no.	Motor length [mm]
1	SH2281	32	SF2421	33	SH1421	33	103H6701	39.8	SM2561	41.8	SH1601	42
2			SF2422	39	SH1422	39			SM2562	53.8	SH1602	54
3			SF2423	48			103H6703	51.3	SM2563	75.8		
4			SF2424	59.5	SH1424	48			SM2564	85.8		
5	SH2285	51.5										

Motor size Full step angle
 28: 28 mm sq., 1.8°
 42: 42 mm sq., 1.8°
 14: 42 mm sq., 0.9°
 67: 50 mm sq., 1.8°
 71: 56 mm sq., 1.8°
 16: 60 mm sq., 0.9°

Stepping motor series
 H : H series
 S : SH or SF series
 M : SM series

Rated current
 4: 1 A/phase, 5: 1.2 A/phase, 6: 2 A/phase

Model

Windings
 U: Unipolar, B: Bipolar

D: DC input

Items Included in a Set These sets include a driver, motor, and motor cable with connectors.

Motors marked with (L) are lead-type motors. 300 mm or longer leads are attached to the motor.
 Motors marked with (C) are connector-type motors. The following motor cables with connectors are included.

Unipolar Bundled driver model no.: US1D200P10

Motor size	Single shaft			Dual shaft			Full step angle	Rated current [A/phase]	Page	
	Set order no.	Items included in a set		Set order no.	Items included in a set				Specifi-cations	Dimen-sions
		Motor model no.	Motor cable with connectors model no.		Motor model no.	Motor cable with connectors model no.				
28 mm sq.	DU14S281S	SH2281-5271	L -	DU14S281D	SH2281-5231	L -	1.8°	1	p. 13	p. 22
	DU14S285S	SH2285-5271	L -	DU14S285D	SH2285-5231	L -	1.8°	1	p. 13	p. 22
42 mm sq.	DU15S421S	SF2421-12U41	C 4835774-1	DU15S421D	SF2421-12U11	C 4835774-1	1.8°	1.2	p. 13	p. 22
	DU15S422S	SF2422-12U41	C 4835774-1	DU15S422D	SF2422-12U11	C 4835774-1	1.8°	1.2	p. 13	p. 22
	DU15S423S	SF2423-12U41	C 4835774-1	DU15S423D	SF2423-12U11	C 4835774-1	1.8°	1.2	p. 14	p. 22
	DU15S424S	SF2424-12U41	C 4835774-1	DU15S424D	SF2424-12U11	C 4835774-1	1.8°	1.2	p. 14	p. 22
	DU15S141S	SH1421-0441	L -	DU15S141D	SH1421-0411	L -	0.9°	1.2	p. 14	p. 22
	DU15S142S	SH1422-0441	L -	DU15S142D	SH1422-0411	L -	0.9°	1.2	p. 14	p. 22
	DU15S144S	SH1424-0441	L -	DU15S144D	SH1424-0411	L -	0.9°	1.2	p. 15	p. 22
56 mm sq.	DU16M711S	SM2561C20U41	C 4837798-1	DU16M711D	SM2561C20U11	C 4837798-1	1.8°	2	p. 15	p. 23
	DU16M712S	SM2562C20U41	C 4837798-1	DU16M712D	SM2562C20U11	C 4837798-1	1.8°	2	p. 15	p. 23
	DU16M713S	SM2563C20U41	C 4837798-1	DU16M713D	SM2563C20U11	C 4837798-1	1.8°	2	p. 15	p. 23
	DU16M714S	SM2564C20U41	C 4837798-1	DU16M714D	SM2564C20U11	C 4837798-1	1.8°	2	p. 16	p. 23

• **Motor cable with connectors** Note: Included with connector-type motors only

For 42 mm sq. unipolar motors (Model no.: 4835774-1)

For 56 mm sq. unipolar motors (Model no.: 4837798-1)

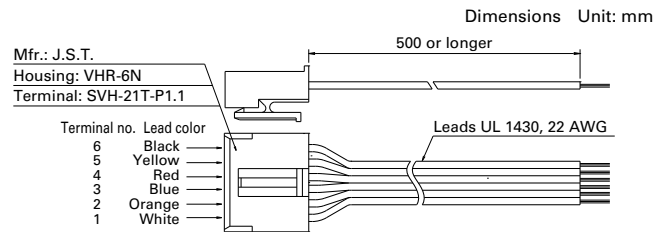
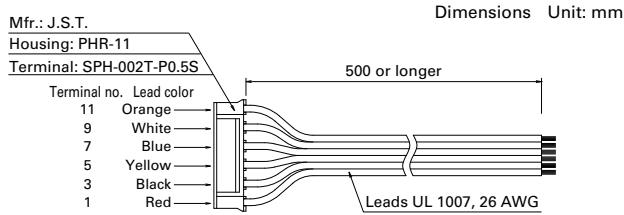

Bipolar Bundled driver model no.: BS1D200P10

Motor size	Single shaft			Dual shaft			Full step angle	Rated current [A/phase]	Page	
	Set order no.	Items included in a set		Set order no.	Items included in a set				Specifi-cations	Dimen-sions
		Motor model no.	Motor cable with connectors model no.		Motor model no.	Motor cable with connectors model no.				
28 mm sq.	DB14S281S	SH2281-5771	L -	DB14S281D	SH2281-5731	L -	1.8°	1	p. 17	p. 22
	DB14S285S	SH2285-5771	L -	DB14S285D	SH2285-5731	L -	1.8°	1	p. 17	p. 22
42 mm sq.	DB14S421S	SF2421-10B41	C 4835775-1	DB14S421D	SF2421-10B11	C 4835775-1	1.8°	1	p. 17	p. 22
	DB14S422S	SF2422-10B41	C 4835775-1	DB14S422D	SF2422-10B11	C 4835775-1	1.8°	1	p. 17	p. 22
	DB14S423S	SF2423-10B41	C 4835775-1	DB14S423D	SF2423-10B11	C 4835775-1	1.8°	1	p. 18	p. 22
	DB14S424S	SF2424-10B41	C 4835775-1	DB14S424D	SF2424-10B11	C 4835775-1	1.8°	1	p. 18	p. 22
	DB16S141S	SH1421-5241	L -	DB16S141D	SH1421-5211	L -	0.9°	2	p. 18	p. 22
	DB16S142S	SH1422-5241	L -	DB16S142D	SH1422-5211	L -	0.9°	2	p. 18	p. 22
	DB16S144S	SH1424-5241	L -	DB16S144D	SH1424-5211	L -	0.9°	2	p. 19	p. 22
50 mm sq.	DB16H671S	103H6701-5040	L -	DB16H671D	103H6701-5010	L -	1.8°	2	p. 19	p. 23
	DB16H673S	103H6703-5040	L -	DB16H673D	103H6703-5010	L -	1.8°	2	p. 19	p. 23
56 mm sq.	DB16M711S	SM2561C20B41	C 4837961-1	DB16M711D	SM2561C20B11	C 4837961-1	1.8°	2	p. 19	p. 23
	DB16M712S	SM2562C20B41	C 4837961-1	DB16M712D	SM2562C20B11	C 4837961-1	1.8°	2	p. 20	p. 23
	DB16M713S	SM2563C20B41	C 4837961-1	DB16M713D	SM2563C20B11	C 4837961-1	1.8°	2	p. 20	p. 23
	DB16M714S	SM2564C20B41	C 4837961-1	DB16M714D	SM2564C20B11	C 4837961-1	1.8°	2	p. 20	p. 23
60 mm sq.	DB16S161S	SH1601-5240	L -	DB16S161D	SH1601-5210	L -	0.9°	2	p. 20	p. 23
	DB16S162S	SH1602-5240	L -	DB16S162D	SH1602-5210	L -	0.9°	2	p. 21	p. 23

• **Motor cable with connectors** Note: Included with connector-type motors only

For 42 mm sq. bipolar motors (Model no.: 4835775-1)

For 56 mm sq. bipolar motors (Model no.: 4837961-1)

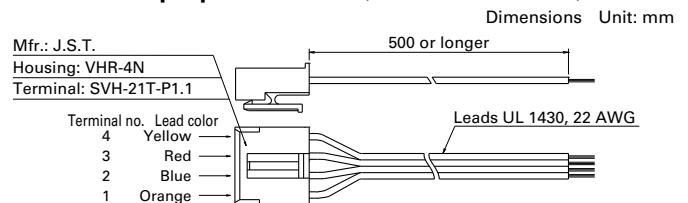
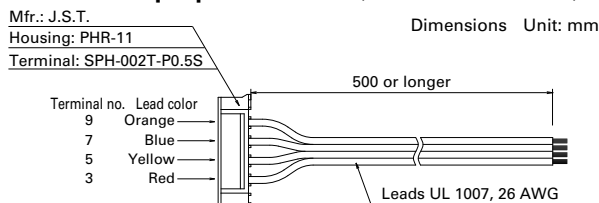

Size	Motor size	28 mm sq. (1.8° full step angle)		42 mm sq. (1.8° full step angle)	
		32 mm	51.5 mm	33 mm	39 mm
Single shaft	Set order no.	DU14S281S	DU14S285S	DU15S421S	DU15S422S
	Motor model no.	SH2281-5271	SH2285-5271	SF2421-12U41	SF2422-12U41
Dual shaft	Set order no.	DU14S281D	DU14S285D	DU15S421D	DU15S422D
	Motor model no.	SH2281-5231	SH2285-5231	SF2421-12U11	SF2422-12U11
Holding torque	N·m	0.055	0.115	0.22	0.33
Rotor inertia	$\times 10^{-4}$ kg·m ²	0.01	0.022	0.031	0.046
Rated current	A/phase	1	1	1.2	1.2
Motor mass ⁽¹⁾	kg	0.11	0.2	0.23	0.3
Allowable thrust load	N	3	3	10	10
Allowable radial load ⁽²⁾	N	42	49	39	37

(1) For the driver mass, see ▶ p. 26

(2) Load is exerted to the shaft end.

Characteristics

With rubber coupling used

Pull-out torque Full step — Half step — fs: Maximum starting pulse rate with no load Full step ● Half step ●
 Input current (with no load) Full step - - - Half step - - - Input current (with load) Full step ····· Half step ·····

DU14S281S DU14S281D

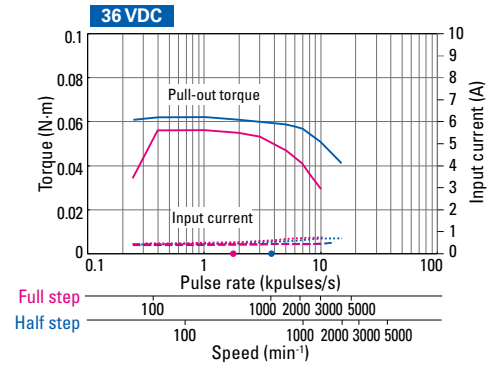
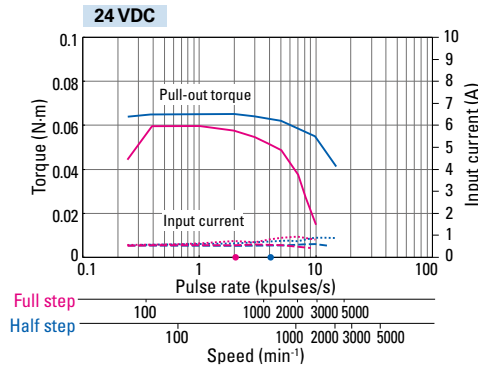

DU14S285S DU14S285D

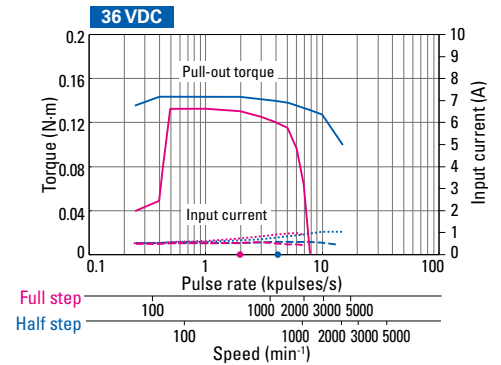
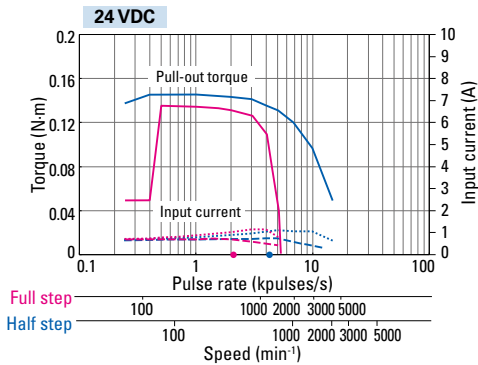

DU15S421S DU15S421D

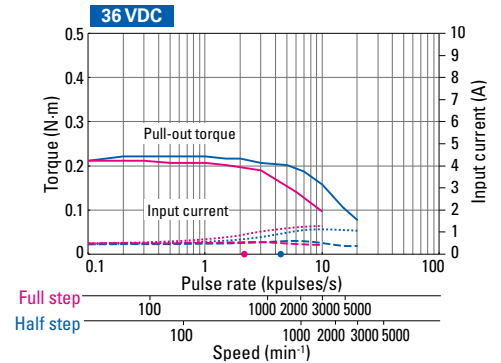
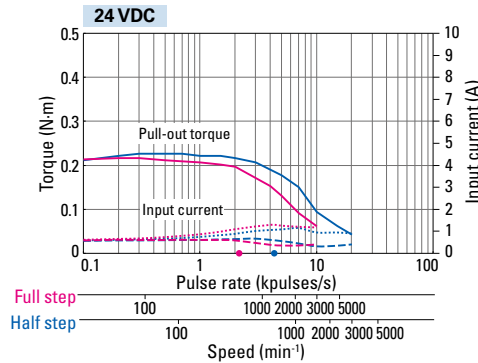

DU15S422S DU15S422D

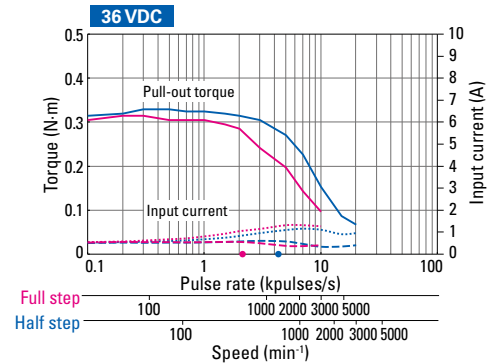
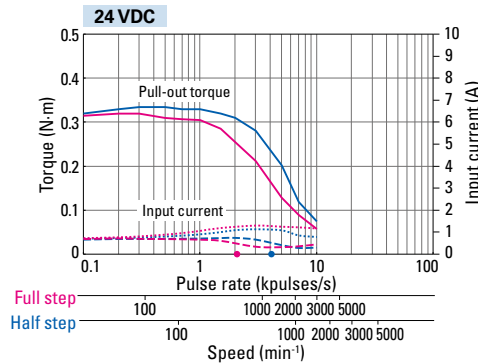

Size	Motor size	42 mm sq. (1.8° full step angle)		42 mm sq. (0.9° full step angle)		
		48 mm	59.5 mm	33 mm	39 mm	
Single shaft	Set order no.	DU15S423S	DU15S424S	DU15S141S	DU15S142S	
	Motor model no.	SF2423-12U41	SF2424-12U41	SH1421-0441	SH1422-0441	
Dual shaft	Set order no.	DU15S423D	DU15S424D	DU15S141D	DU15S142D	
	Motor model no.	SF2423-12U11	SF2424-12U11	SH1421-0411	SH1422-0411	
Holding torque		N·m	0.4	0.58	0.2	0.29
Rotor inertia		$\times 10^{-4}$ kg·m ²	0.063	0.094	0.044	0.066
Rated current		A/phase	1.2	1.2	1.2	1.2
Motor mass ⁽¹⁾		kg	0.38	0.51	0.24	0.29
Allowable thrust load		N	10	10	10	10
Allowable radial load ⁽²⁾		N	35	29	25	24

(1) For the driver mass, see ▶ p. 26

(2) Load is exerted to the shaft end.

Characteristics

With rubber coupling used

Pull-out torque Full step — Half step — fs: Maximum starting pulse rate with no load Full step ● Half step ●
 Input current (with no load) Full step - - - Half step - - - Input current (with load) Full step ····· Half step ·····

DU15S423S DU15S423D

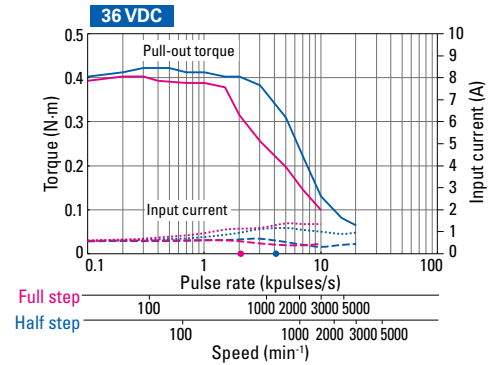
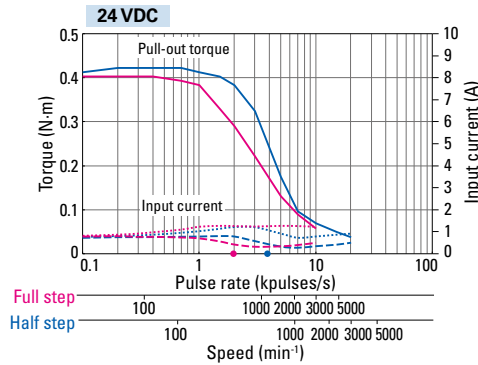

DU15S424S DU15S424D

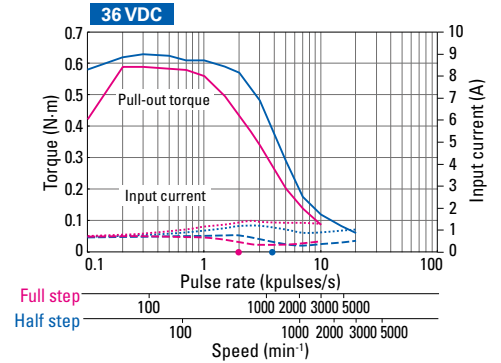
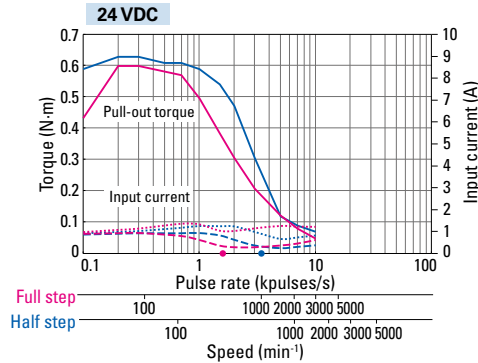

DU15S141S DU15S141D

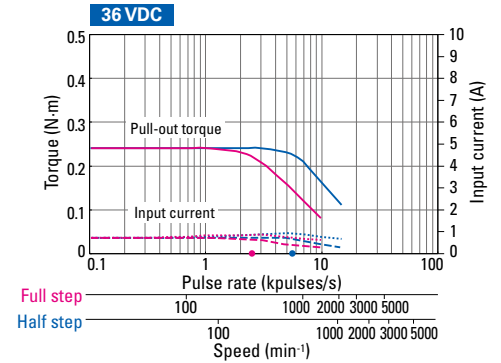
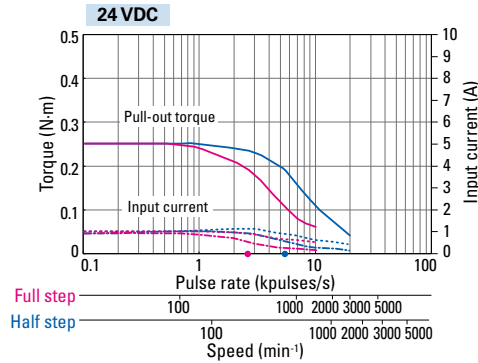

DU15S142S DU15S142D

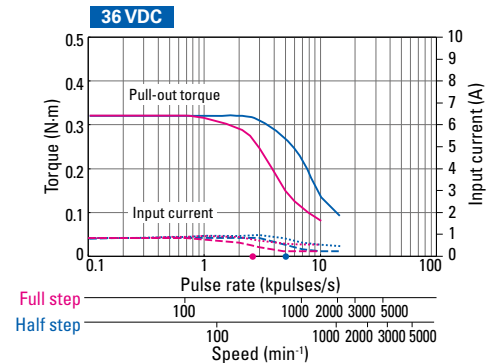
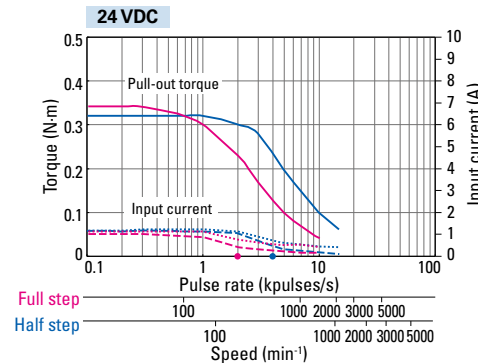

Size	Motor size	42 mm sq. (0.9° full step angle)	56 mm sq. (1.8° full step angle)			
	Motor length	48 mm	41.8 mm	53.8 mm	75.8 mm	
Single shaft	Set order no.	DU15S144S	DU16M711S	DU16M712S	DU16M713S	
	Motor model no.	SH1424-0441	SM2561C20U41	SM2562C20U41	SM2563C20U41	
Dual shaft	Set order no.	DU15S144D	DU16M711D	DU16M712D	DU16M713D	
	Motor model no.	SH1424-0411	SM2561C20U11	SM2562C20U11	SM2563C20U11	
Holding torque		N·m	0.39	0.53	1.1	1.7
Rotor inertia		$\times 10^{-4}$ kg·m ²	0.089	0.14	0.28	0.5
Rated current		A/phase	1.2	2	2	2
Motor mass ⁽¹⁾		kg	0.38	0.49	0.69	1.1
Allowable thrust load		N	10	20	20	20
Allowable radial load ⁽²⁾		N	20	115	106	93

(1) For the driver mass, see ▶ p. 26

(2) Load is exerted to the shaft end.

Characteristics

With rubber coupling used

Pull-out torque — Full step — Half step — fs: Maximum starting pulse rate with no load
 Input current (with no load) — Full step — Half step — Input current (with load) — Full step — Half step

DU15S144S DU15S144D

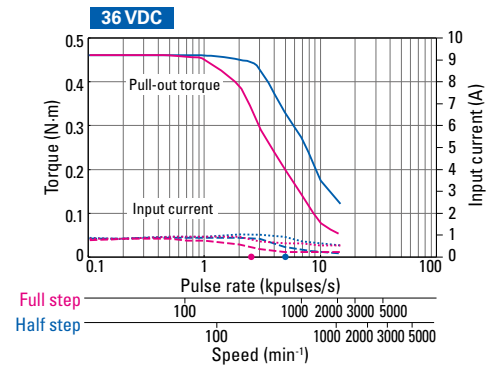
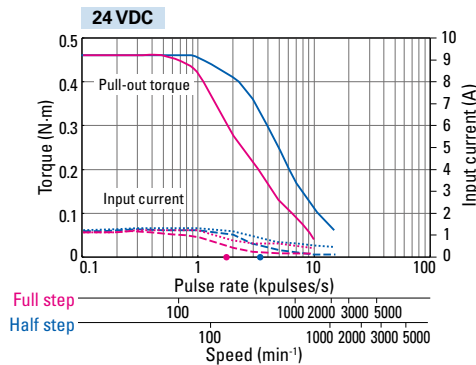

DU16M711S DU16M711D

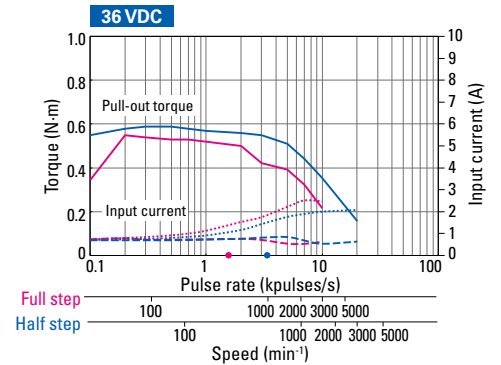
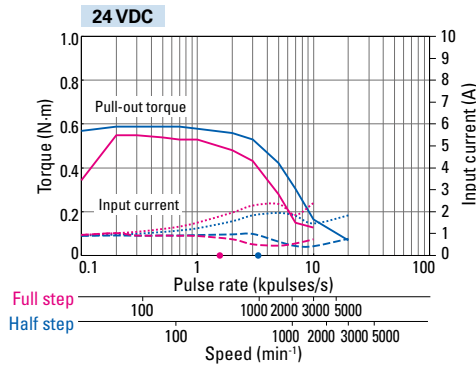

DU16M712S DU16M712D

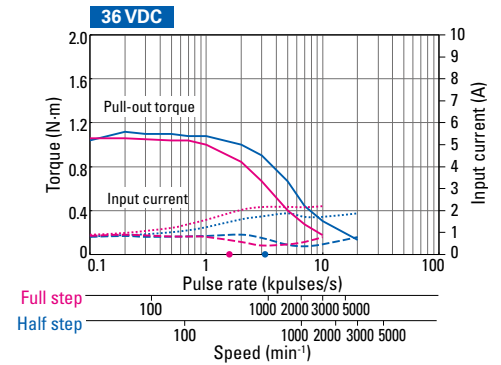
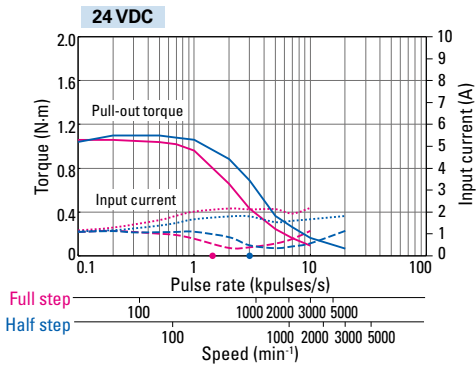

DU16M713S DU16M713D

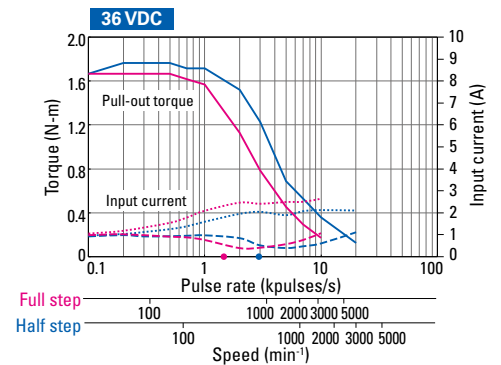
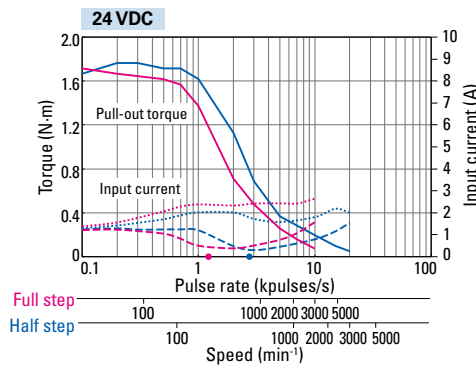

Size	Motor size	56 mm sq. (1.8° full step angle)
	Motor length	85.8 mm
Single shaft	Set order no.	DU16M714S
	Motor model no.	SM2564C20U41
Dual shaft	Set order no.	DU16M714D
	Motor model no.	SM2564C20U11
Holding torque	N·m	1.75
Rotor inertia	$\times 10^{-4}$ kg·m ²	0.6
Rated current	A/phase	2
Motor mass ⁽¹⁾	kg	1.27
Allowable thrust load	N	20
Allowable radial load ⁽²⁾	N	86

(1) For the driver mass, see ▶ p. 26

(2) Load is exerted to the shaft end.

Characteristics

With rubber coupling used

Pull-out torque Full step — Half step — fs: Maximum starting pulse rate with no load Full step ● Half step ●
 Input current (with no load) Full step - - - Half step - - - Input current (with load) Full step Half step

DU16M714S
DU16M714D

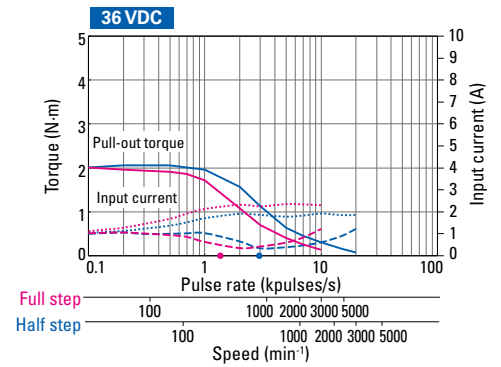
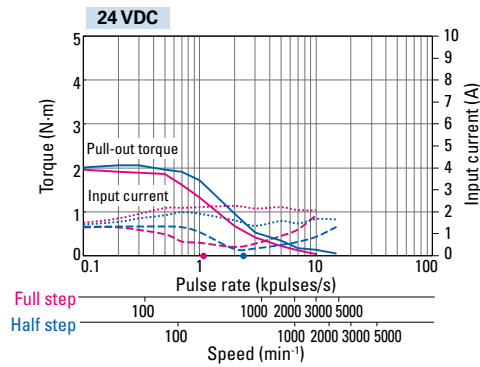

Size	Motor size	28 mm sq. (1.8° full step angle)		42 mm sq. (1.8° full step angle)	
		32 mm	51.5 mm	33 mm	39 mm
Single shaft	Set order no.	DB14S281S	DB14S285S	DB14S421S	DB14S422S
	Motor model no.	SH2281-5771	SH2285-5771	SF2421-10B41	SF2422-10B41
Dual shaft	Set order no.	DB14S281D	DB14S285D	DB14S421D	DB14S422D
	Motor model no.	SH2281-5731	SH2285-5731	SF2421-10B11	SF2422-10B11
Holding torque		N·m		0.29	
Rotor inertia		$\times 10^{-4}$ kg·m ²		0.031	
Rated current		A/phase		1	
Motor mass ⁽¹⁾		kg		0.23	
Allowable thrust load		N		10	
Allowable radial load ⁽²⁾		N		38	

(1) For the driver mass, see ▶ p. 26

(2) Load is exerted to the shaft end.

Characteristics

With rubber coupling used

Pull-out torque Full step — Half step — fs: Maximum starting pulse rate with no load Full step ● Half step ●
 Input current (with no load) Full step - - - Half step - - - Input current (with load) Full step ····· Half step ·····

DB14S281S
DB14S281D

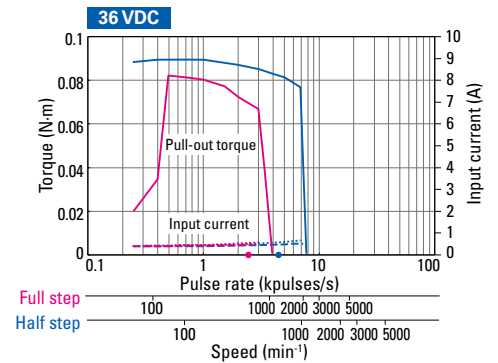
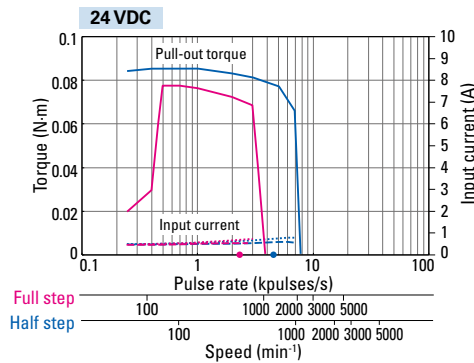

DB14S285S
DB14S285D

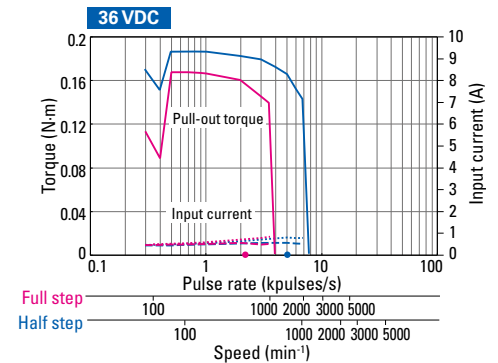
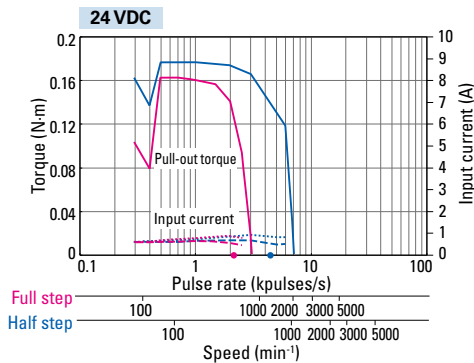

DB14S421S
DB14S421D

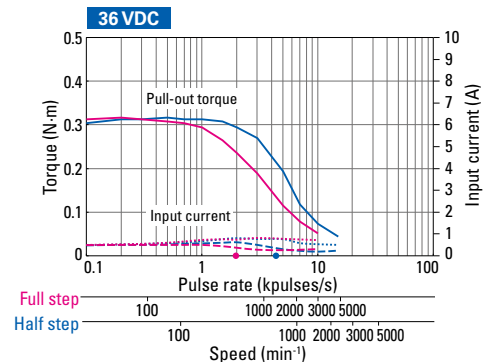
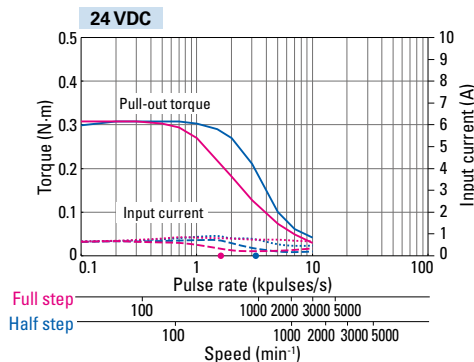

DB14S422S
DB14S422D

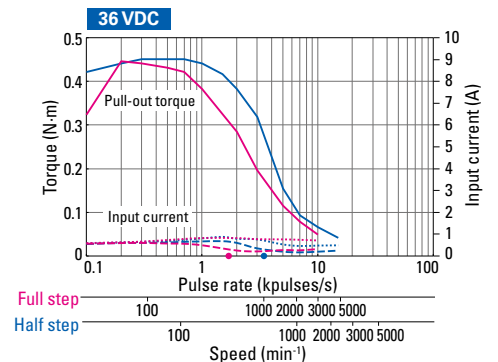
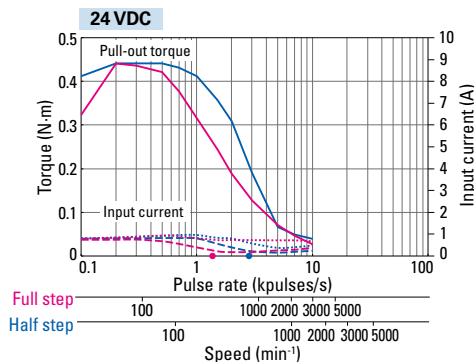

Size	Motor size	42 mm sq. (1.8° full step angle)		42 mm sq. (0.9° full step angle)	
		48 mm	59.5 mm	33 mm	39 mm
Single shaft	Motor length				
	Set order no.	DB14S423S	DB14S424S	DB16S141S	DB16S142S
Dual shaft	Motor model no.	SF2423-10B41	SF2424-10B41	SH1421-5241	SH1422-5241
	Set order no.	DB14S423D	DB14S424D	DB16S141D	DB16S142D
Holding torque	Motor model no.	SF2423-10B11	SF2424-10B11	SH1421-5211	SH1422-5211
	N·m	0.56	0.8	0.23	0.34
Rated current	$\times 10^{-4}$ kg·m ²	0.063	0.094	0.044	0.066
Motor mass ⁽¹⁾	A/phase	1	1	2	2
Allowable thrust load	kg	0.38	0.51	0.24	0.29
Allowable radial load ⁽²⁾	N	10	10	10	10
	N	30	20	25	24

(1) For the driver mass, see ▶ p. 26

(2) Load is exerted to the shaft end.

Characteristics

With rubber coupling used

Pull-out torque Full step — Half step — fs: Maximum starting pulse rate with no load Full step ● Half step ●
 Input current (with no load) Full step - - - Half step - - - Input current (with load) Full step ····· Half step ·····

DB14S423S DB14S423D

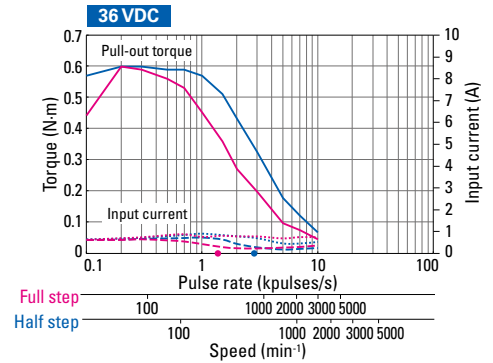
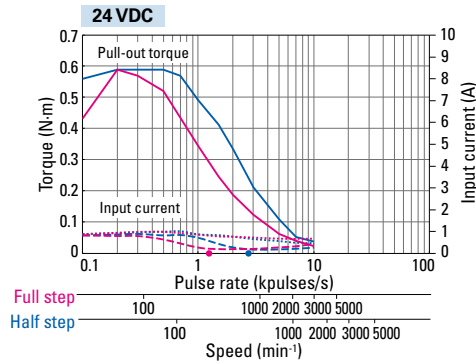

DB14S424S DB14S424D

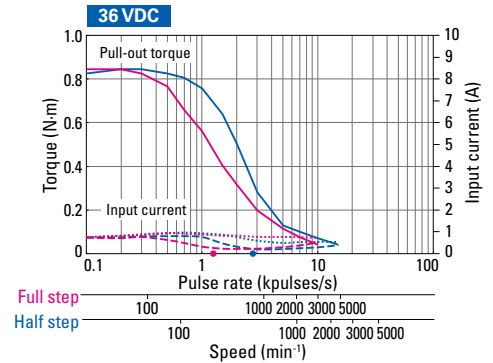
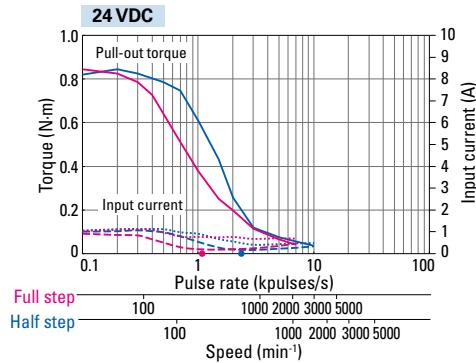

DB16S141S DB16S141D

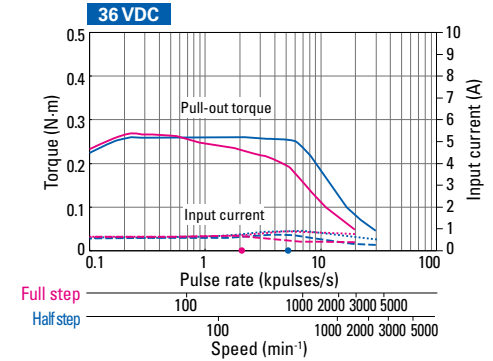
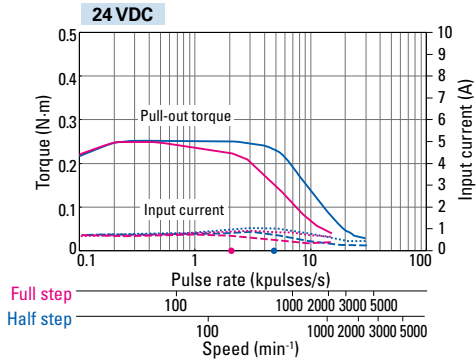

DB16S142S DB16S142D

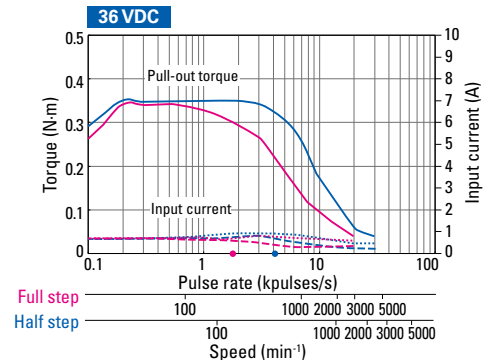
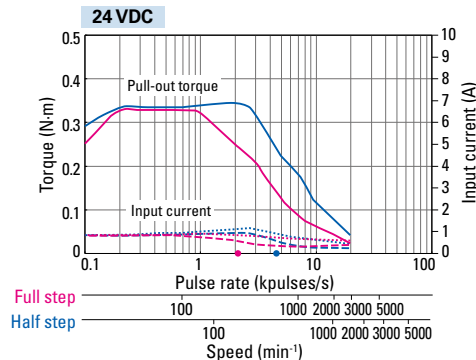

Size	Motor size	42 mm sq. (0.9° full step angle)	50 mm sq. (1.8° full step angle)		56 mm sq. (1.8° full step angle)	
	Motor length	48 mm	39.8 mm	51.3 mm	41.8 mm	
Single shaft	Set order no.	DB16S144S	DB16H671S	DB16H673S	DB16M711S	
	Motor model no.	SH1424-5241	103H6701-5040	103H6703-5040	SM2561C20B41	
Dual shaft	Set order no.	DB16S144D	DB16H671D	DB16H673D	DB16M711D	
	Motor model no.	SH1424-5211	103H6701-5010	103H6703-5010	SM2561C20B11	
Holding torque		N·m	0.48	0.28	0.49	0.75
Rotor inertia		$\times 10^{-4}$ kg·m ²	0.089	0.057	0.118	0.14
Rated current		A/phase	2	2	2	2
Motor mass ⁽¹⁾		kg	0.38	0.35	0.5	0.49
Allowable thrust load		N	10	15	15	20
Allowable radial load ⁽²⁾		N	20	79	75	113

(1) For the driver mass, see ▶ p. 26

(2) Load is exerted to the shaft end.

Characteristics

With rubber coupling used

Pull-out torque Full step — Half step — fs: Maximum starting pulse rate with no load Full step ● Half step ●
 Input current (with no load) Full step - - - Half step - - - Input current (with load) Full step ····· Half step ·····

**DB16S144S
DB16S144D**

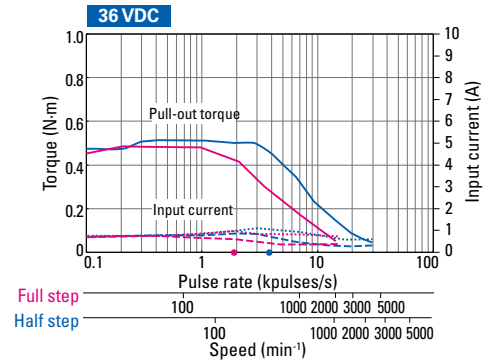
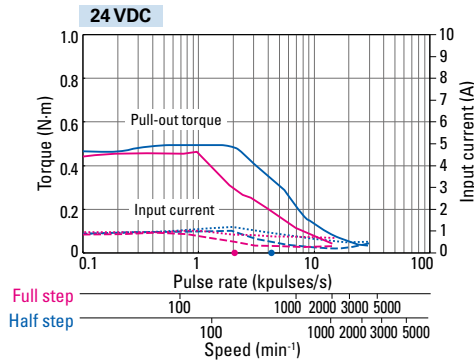

**DB16H671S
DB16H671D**

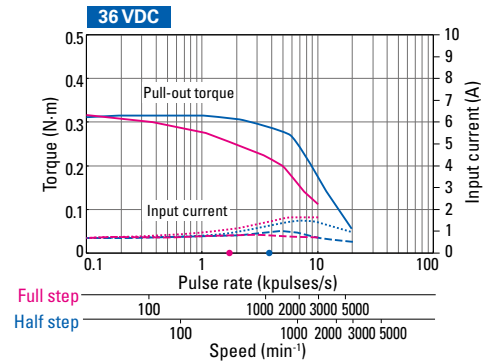
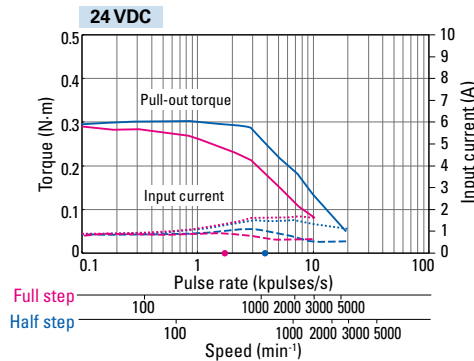

**DB16H673S
DB16H673D**

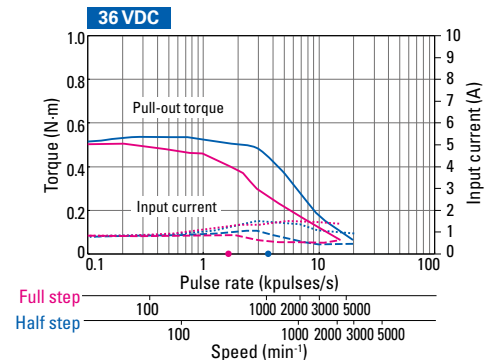
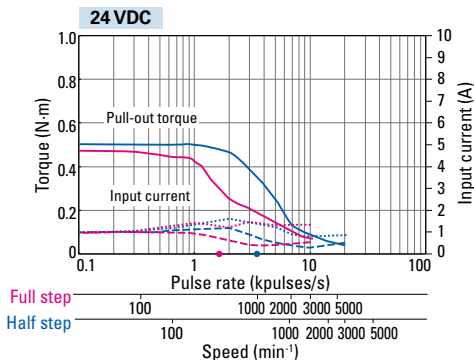

**DB16M711S
DB16M711D**

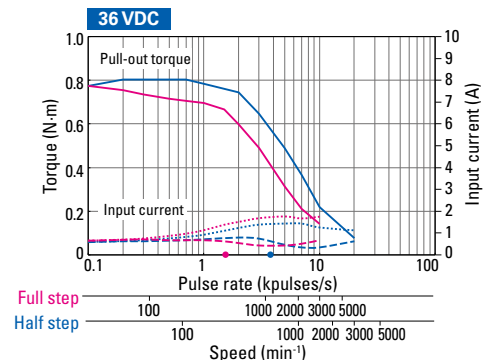
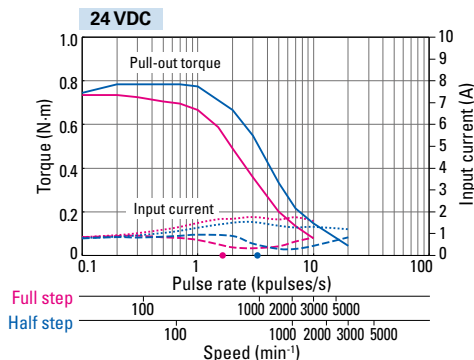

Size	Motor size	56 mm sq. (1.8° full step angle)			60 mm sq. (0.9° full step angle)
	Motor length	53.8 mm	75.8 mm	85.8 mm	42 mm
Single shaft	Set order no.	DB16M712S	DB16M713S	DB16M714S	DB16S161S
	Motor model no.	SM2562C20B41	SM2563C20B41	SM2564C20B41	SH1601-5240
Dual shaft	Set order no.	DB16M712D	DB16M713D	DB16M714D	DB16S161D
	Motor model no.	SM2562C20B11	SM2563C20B11	SM2564C20B11	SH1601-5210
Holding torque	N·m	1.4	2.35	2.5	0.69
Rotor inertia	$\times 10^{-4}$ kg·m ²	0.28	0.5	0.6	0.24
Rated current	A/phase	2	2	2	2
Motor mass ⁽¹⁾	kg	0.69	1.1	1.27	0.55
Allowable thrust load	N	20	20	20	15
Allowable radial load ⁽²⁾	N	102	78	70	78

(1) For the driver mass, see ▶ p. 26

(2) Load is exerted to the shaft end.

Characteristics

With rubber coupling used

Pull-out torque Full step — Half step — fs: Maximum starting pulse rate with no load Full step ● Half step ●
 Input current (with no load) Full step - - - Half step - - - Input current (with load) Full step ····· Half step ·····

DB16M712S DB16M712D

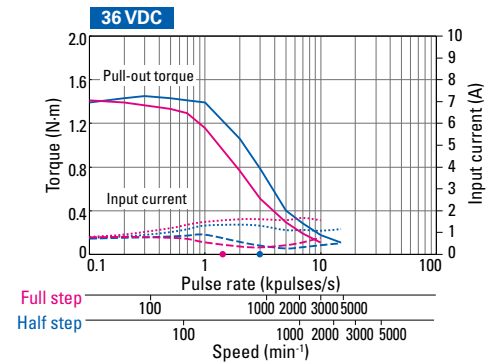
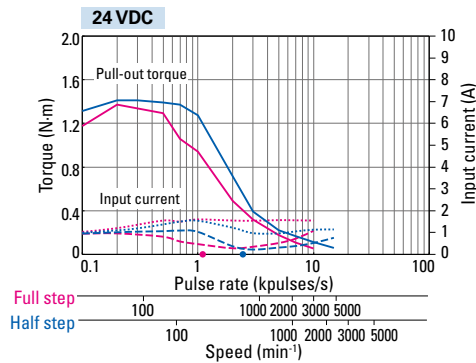

DB16M713S DB16M713D

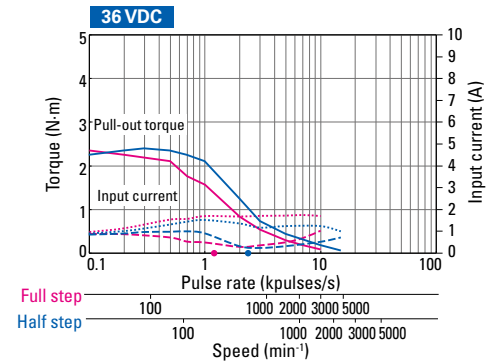
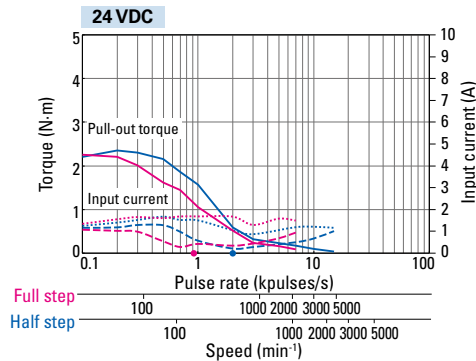

DB16M714S DB16M714D

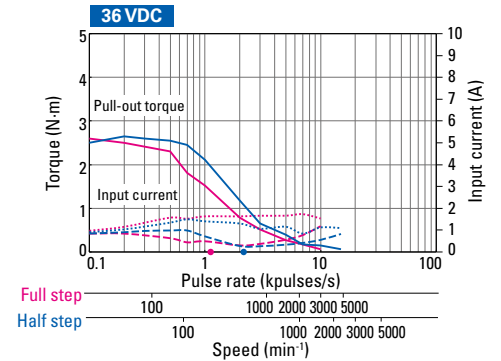
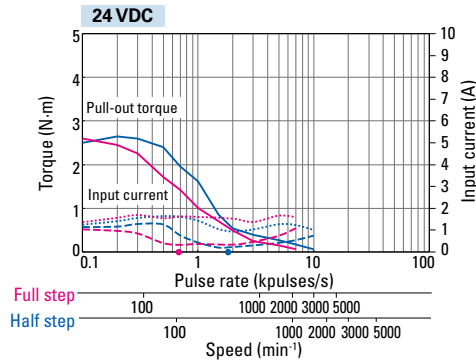

DB16S161S DB16S161D

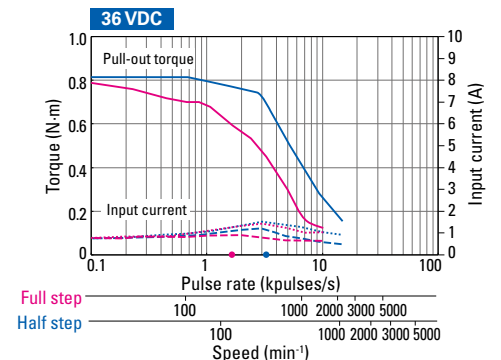
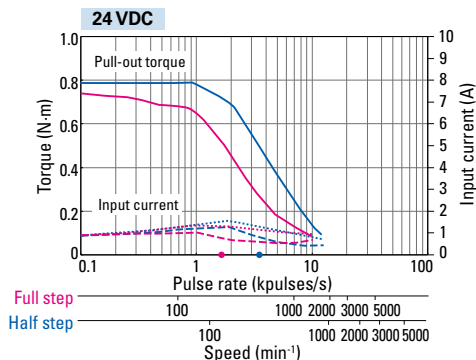

Size	Motor size	60 mm sq. (0.9° full step angle)
	Motor length	54 mm
Single shaft	Set order no.	DB16S162S
	Motor model no.	SH1602-5240
Dual shaft	Set order no.	DB16S162D
	Motor model no.	SH1602-5210
Holding torque	N·m	1.28
Rotor inertia	$\times 10^{-4}$ kg·m ²	0.4
Rated current	A/phase	2
Motor mass ⁽¹⁾	kg	0.8
Allowable thrust load	N	15
Allowable radial load ⁽²⁾	N	65

(1) For the driver mass, see ▶ p. 26

(2) Load is exerted to the shaft end.

Characteristics

With rubber coupling used

Pull-out torque Full step — Half step — fs: Maximum starting pulse rate with no load Full step ● Half step ●
 Input current (with no load) Full step - - - Half step - - - Input current (with load) Full step Half step

DB16S162S
DB16S162D

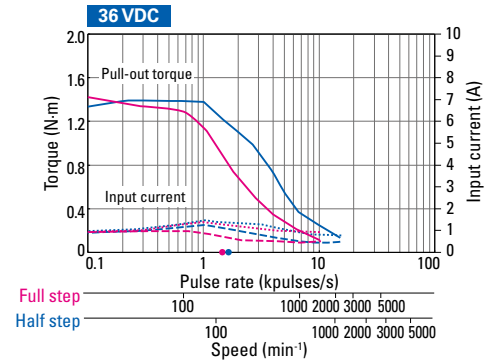
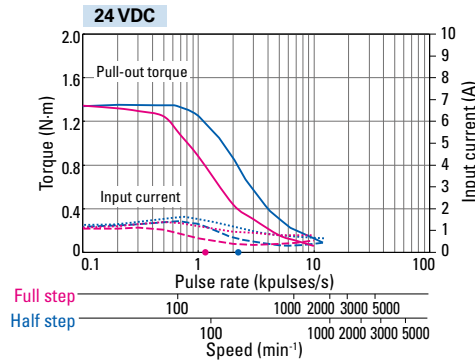

Stepping Motor Dimensions Unit: mm

28 mm sq.

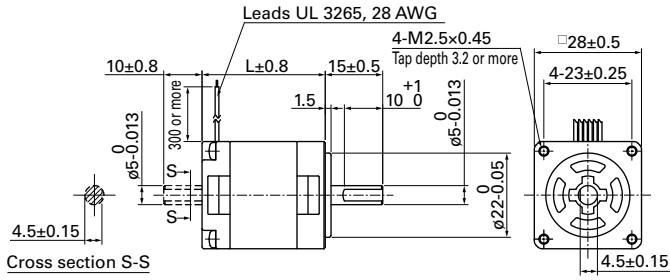

Note: The figure above shows a unipolar motor. The bipolar variant has four leads.

Unipolar

Set order no.		Motor model no.		Motor length (L)
Single shaft	Dual shaft	Single shaft	Dual shaft	
DU14S281S	DU14S281D	SH2281-5271	SH2281-5231	32
DU14S285S	DU14S285D	SH2285-5271	SH2285-5231	51.5

Bipolar

Set order no.		Motor model no.		Motor length (L)
Single shaft	Dual shaft	Single shaft	Dual shaft	
DB14S281S	DB14S281D	SH2281-5771	SH2281-5731	32
DB14S285S	DB14S285D	SH2285-5771	SH2285-5731	51.5

42 mm sq.

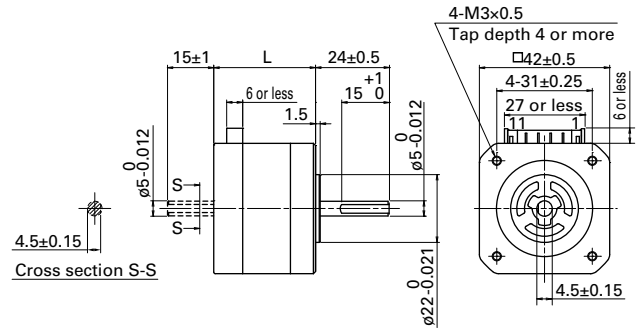

Unipolar

Set order no.		Motor model no.		Motor length (L)
Single shaft	Dual shaft	Single shaft	Dual shaft	
DU15S421S	DU15S421D	SF2421-12U41	SF2421-12U11	33 ± 0.5
DU15S422S	DU15S422D	SF2422-12U41	SF2422-12U11	39 ± 0.5
DU15S423S	DU15S423D	SF2423-12U41	SF2423-12U11	48 ± 0.5
DU15S424S	DU15S424D	SF2424-12U41	SF2424-12U11	59.5 ± 1

Bipolar

Set order no.		Motor model no.		Motor length (L)
Single shaft	Dual shaft	Single shaft	Dual shaft	
DB14S421S	DB14S421D	SF2421-10B41	SF2421-10B11	33 ± 0.5
DB14S422S	DB14S422D	SF2422-10B41	SF2422-10B11	39 ± 0.5
DB14S423S	DB14S423D	SF2423-10B41	SF2423-10B11	48 ± 0.5
DB14S424S	DB14S424D	SF2424-10B41	SF2424-10B11	59.5 ± 1

42 mm sq.

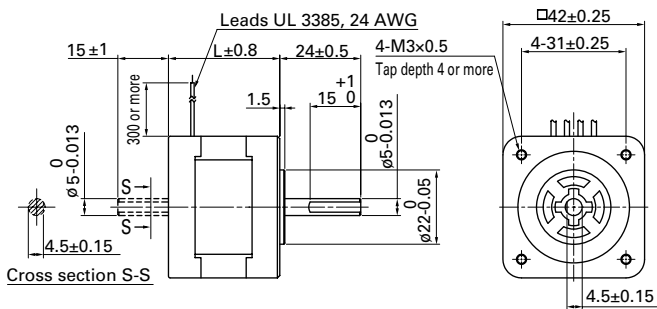

Note: The figure above shows a bipolar motor. The unipolar variant has six leads.

Unipolar

Set order no.		Motor model no.		Motor length (L)
Single shaft	Dual shaft	Single shaft	Dual shaft	
DU15S141S	DU15S141D	SH1421-0441	SH1421-0411	33
DU15S142S	DU15S142D	SH1422-0441	SH1422-0411	39
DU15S144S	DU15S144D	SH1424-0441	SH1424-0411	48

Bipolar

Set order no.		Motor model no.		Motor length (L)
Single shaft	Dual shaft	Single shaft	Dual shaft	
DB16S141S	DB16S141D	SH1421-5241	SH1421-5211	33
DB16S142S	DB16S142D	SH1422-5241	SH1422-5211	39
DB16S144S	DB16S144D	SH1424-5241	SH1424-5211	48

Unipolar motor cable 4835774-1

Mfr.: J.S.T.

Housing: PHR-11

Terminal: SPH-002T-P0.5S

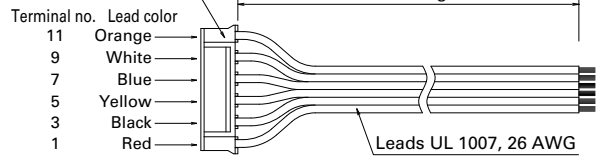

This is a motor-driver cable for use with SF242□-12U□1 motors.

Bipolar motor cable 4835775-1

Mfr.: J.S.T.

Housing: PHR-11

Terminal: SPH-002T-P0.5S

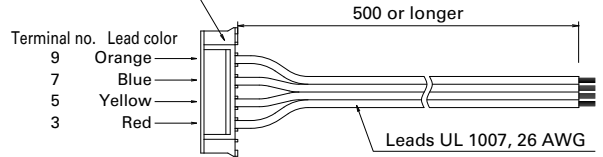

This is a motor-driver cable for use with SF242□-10B□1 motors.

Stepping Motor Dimensions Unit: mm

50 mm sq.

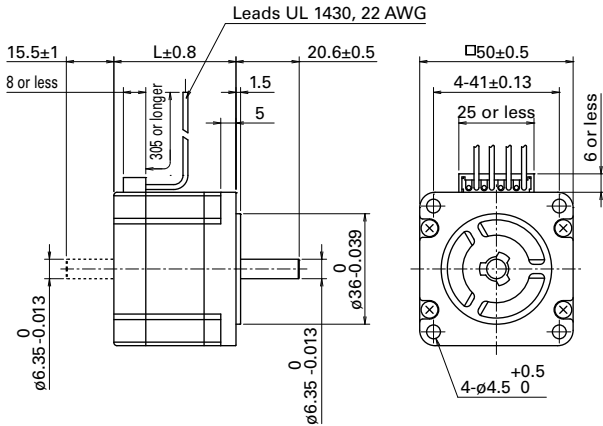

Bipolar

Set order no.		Motor model no.		Motor length (L)
Single shaft	Dual shaft	Single shaft	Dual shaft	
DB16H671S	DB16H671D	103H6701-5040	103H6701-5010	39.8
DB16H673S	DB16H673D	103H6703-5040	103H6703-5010	51.3

56 mm sq.

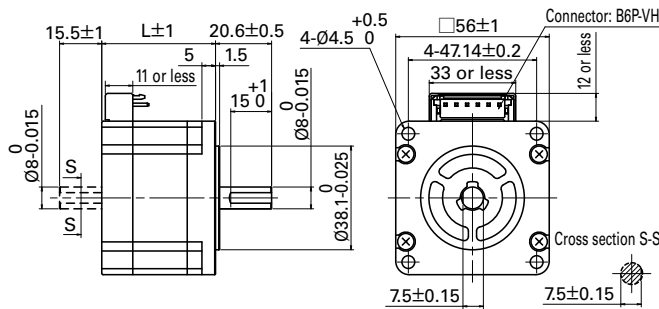

Unipolar

Set order no.		Motor model no.		Motor length (L)
Single shaft	Dual shaft	Single shaft	Dual shaft	
DU16M711S	DU16M711D	SM2561C20U41	SM2561C20U11	41.8
DU16M712S	DU16M712D	SM2562C20U41	SM2562C20U11	53.8
DU16M713S	DU16M713D	SM2563C20U41	SM2563C20U11	75.8
DU16M714S	DU16M714D	SM2564C20U41	SM2564C20U11	85.8

Unipolar motor cable 4837798-1

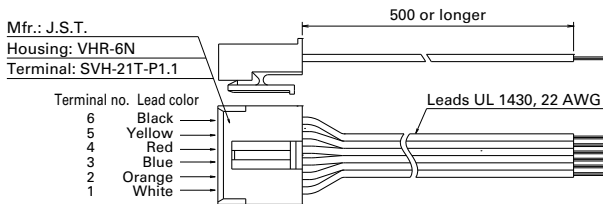

56 mm sq.

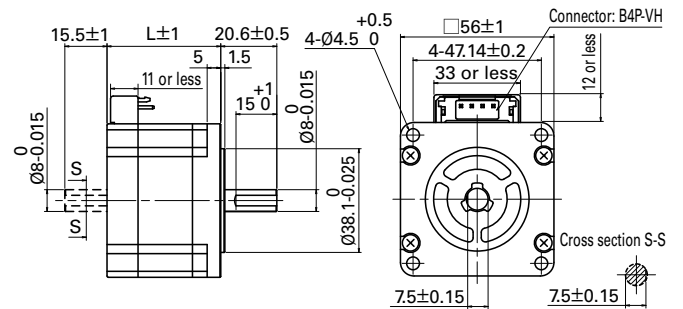

Bipolar

Set order no.		Motor model no.		Motor length (L)
Single shaft	Dual shaft	Single shaft	Dual shaft	
DB16M711S	DB16M711D	SM2561C20B41	SM2561C20B11	41.8
DB16M712S	DB16M712D	SM2562C20B41	SM2562C20B11	53.8
DB16M713S	DB16M713D	SM2563C20B41	SM2563C20B11	75.8
DB16M714S	DB16M714D	SM2564C20B41	SM2564C20B11	85.8

Bipolar motor cable 4837961-1

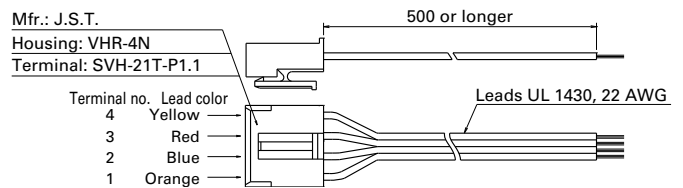

60 mm sq.

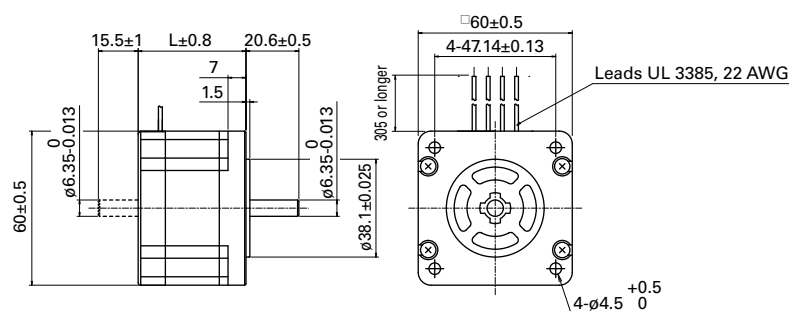

Bipolar

Set order no.		Motor model no.		Motor length (L)
Single shaft	Dual shaft	Single shaft	Dual shaft	
DB16S161S	DB16S161D	SH1601-5240	SH1601-5210	42
DB16S162S	DB16S162D	SH1602-5240	SH1602-5210	54

General Specifications of Stepping Motors

Motor model no.	SH228 <input type="checkbox"/>	SH142 <input type="checkbox"/>	SF242 <input type="checkbox"/>	103H670 <input type="checkbox"/>	SM256 <input type="checkbox"/>	SH160 <input type="checkbox"/>
Operation type	-					
Operating ambient temperature	-10 to +50°C					
Storage temperature	-20 to +65°C					
Operating ambient humidity	20 to 90% RH (non-condensing)					
Storage humidity	5 to 95 % RH (non-condensing)					
Operating altitude	Up to 1000 m above sea level					
Vibration resistance	Frequency 10 to 500 Hz, amplitude 1.52 mm (10 to 70 Hz), acceleration 150 m/s ² (70 to 500 Hz), sweep time 15 min/cycle, 12 cycles for each of both directions in each X, Y, and Z axes.					
Shock resistance	Acceleration 500 m/s ² , duration 11 ms, half sine wave, tested 3 times in both directions for each X, Y, and Z axis for a total of 18 times					
Thermal class	B (+130°C)				B (+130°C) (A for UL models)	B (+130°C)
Dielectric strength	No abnormality after application of 500 VAC at 50/60 Hz between the motor winding and motor frame for one minute at normal temperature and humidity.			No abnormality after application of 1000 VAC at 50/60 Hz between the motor winding and motor frame for one minute at normal temperature and humidity.	No abnormality after application of 1120 VAC at 50/60 Hz between the motor winding and motor frame for one minute at normal temperature and humidity.	No abnormality after application of 1000 VAC at 50/60 Hz between the motor winding and motor frame for one minute at normal temperature and humidity.
Insulation resistance	100 MΩ or more with a 500 VDC megger between the motor winding and motor frame at normal temperature and humidity.					
Protection rating	-					
Winding temperature rise	80 K or less (based on our own standard)					
Positional accuracy tolerance	± 0.09°	± 0.054°	± 0.09°		± 0.054°	± 0.054°
Thrust play ⁽¹⁾	0.075 mm or less (With a 1.5 N load)	0.075 mm or less (With a 5 N load)	0.075 mm (With a 5 N load)	0.075 mm (With a 10 N load)	0.075 mm (With a 10 N load)	0.075 mm (With a 10 N load)
Radial play ⁽²⁾	0.025 mm (With a 5 N load)					
Runout of shaft	0.025 mm					
Concentricity of motor shaft and fitting part	ø0.05 mm	ø0.05 mm	ø0.05 mm	ø0.075 mm	ø0.075 mm	ø0.075 mm
Perpendicularity of mounting surface and motor shaft surface	0.1 mm	0.1 mm	0.1 mm	0.1 mm	0.1 mm	0.1 mm
Motor mounting orientation	Can be installed vertically or horizontally.					

(1) Thrust play: Shaft position displacement when a load is exerted in a direction parallel to the motor shaft.

(2) Radial play: Maximum shaft position displacement when a load is exerted in a direction perpendicular to the motor shaft. Load is exerted on the point 1/3 the shaft length from the shaft end.

Safety standards

Model no.: SM256 UL models

	Classification	Standards	File no.
UL	UL	UL 1004-1, UL 1004-6	E179832
	UL for Canada (cUL)	CSA C22.2 No. 100	

Internal Wiring and Rotational Directions

Unipolar winding

Connector type, model no.: SF242

Internal wiring

In parentheses are lead colors of the motor cable

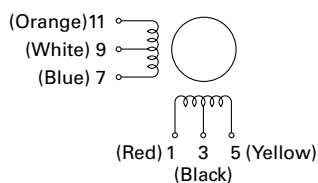

Direction of motor rotation

When excited by a direct current in the order shown below, the direction of rotation is clockwise as viewed from the output shaft side.

		Connector pin no.				
		3, 9	1	7	5	11
Excitation sequence	1	+	-	-		
	2	+		-	-	
	3	+			-	-
	4	+	-			-

Connector type, model no.: SM256

Internal wiring

In parentheses are lead colors of the motor cable

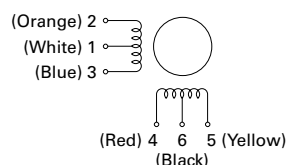

Direction of motor rotation

When excited by a direct current in the order shown below, the direction of rotation is clockwise as viewed from the output shaft side.

		Connector pin no.				
		1, 6	4	3	5	2
Excitation sequence	1	+	-	-		
	2	+		-	-	
	3	+			-	-
	4	+	-			-

Lead type

Internal wiring

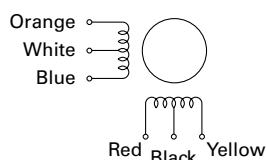

Direction of motor rotation

When excited by a direct current in the order shown below, the direction of rotation is clockwise as viewed from the output shaft side.

		Lead color				
		White, Black	Red	Blue	Yellow	Orange
Excitation sequence	1	+	-	-		
	2	+		-	-	
	3	+			-	-
	4	+	-			-

Bipolar winding

Connector type, model no.: SF242

Internal wiring

In parentheses are lead colors of the motor cable

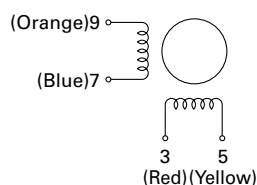

Direction of motor rotation

When excited by a direct current in the order shown below, the direction of rotation is clockwise as viewed from the output shaft side.

		Connector pin no.			
		3	7	5	9
Excitation sequence	1	-	-	+	+
	2	+	-	-	+
	3	+	+	-	-
	4	-	+	+	-

Connector type, model no.: SM256

Internal wiring

In parentheses are lead colors of the motor cable

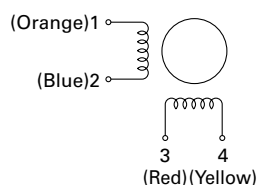

Direction of motor rotation

When excited by a direct current in the order shown below, the direction of rotation is clockwise as viewed from the output shaft side.

		Connector pin no.			
		3	2	4	1
Excitation sequence	1	-	-	+	+
	2	+	-	-	+
	3	+	+	-	-
	4	-	+	+	-

Lead type

Internal wiring

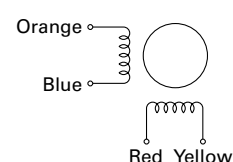

Direction of motor rotation

When excited by a direct current in the order shown below, the direction of rotation is clockwise as viewed from the output shaft side.

		Lead color			
		Red	Blue	Yellow	Orange
Excitation sequence	1	-	-	+	+
	2	+	-	-	+
	3	+	+	-	-
	4	-	+	+	-

Driver Dimensions Unit: mm

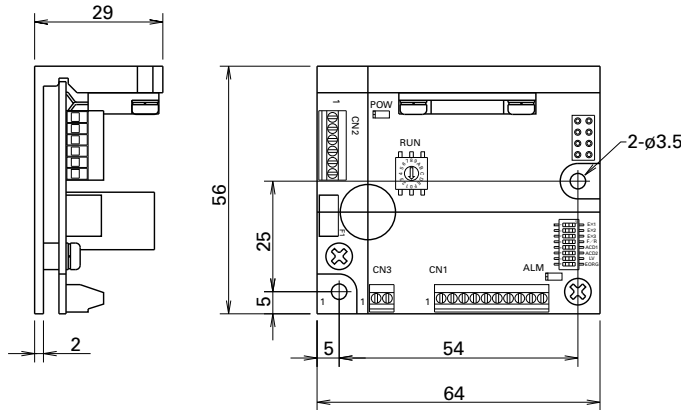

Driver Specifications

General specifications

		Unipolar	Bipolar	
Basic specifications	Model no.	US1D200P10	BS1D200P10	
	Input voltage	24/36 VDC ± 10%		
	Input current	3 A		
	Environment	Protection class	Class III	
		Operating environment	Installation category (Overvoltage category): I, pollution level: 2	
		Operating ambient temperature	0 to +50°C	
		Storage temperature	-20 to +70°C	
		Operating ambient humidity	35 to 85 % RH (non-condensing)	
		Storage humidity	10 to 90% RH (non-condensing)	
		Operating altitude	Up to 1000 m above sea level	
		Vibration resistance	5 m/s ² freq. range 10 to 55 Hz tested for 2 hours in each X, Y and Z-axis directions	
		Shock resistance	Not abnormality observed as per NDS-C-0110 section 3.2.2 category C.	
Dielectric strength		No error when applying 0.5 kVAC for a minute between power input terminal and chassis.		
Insulation resistance	10 MΩ or more with 500 VDC megger between power input terminal and chassis.			
Mass	0.09 kg			
Functions	Mode selection	Step angle mode, input pulse mode, low vibration mode, current at rest, operating current, initial excitation phase		
	Protective functions	Open phase, main circuit power supply undervoltage		
	LED indicators	Power supply monitoring, alarm indicator		
I/O signal	Command pulse input signal	Photocoupler input method; input resistance: 220 Ω, high-level input signal voltage: 4.0 to 5.5 V, low-level input signal voltage: 0 to 0.5 V, maximum starting pulse rate 150 pulses/s		
	Power down input signal	Photocoupler input method; input resistance: 220 Ω, high-level input signal voltage: 4.0 to 5.5 V, low-level input signal voltage: 0 to 0.5 V		
	Phase origin monitor output	Open-collector output through photo coupler, V _{ceo} : 40 V or less, I _c : 10 mA or less		
	Alarm output signal	Open-collector output through photo coupler, V _{ceo} : 40 V or less, I _c : 10 mA or less		

Safety standards

	Directive	Category	Standards	Name
CE (TÜV)	Low Voltage Directive	—	EN 61010-1	—
	EMC Directive	Emission	EN 55011-A	Terminal disturbance voltage
			EN 55011-A	Electromagnetic radiation disturbance
			EN 61000-4-2	ESD (Electrostatic discharge)
		Immunity	EN 61000-4-3	Radiated, radio-frequency, electromagnetic field
			EN 61000-4-4	Fast transients/burst
			EN 61000-4-6	Conducted disturbances
UL	Classification		Standards	File no.
	UL		UL 508C	E179775
	UL for Canada (cUL)			

- Actual EMC levels vary depending on the configuration of the users' control panel where a driver and stepping motor are built in, and the placement layout of other electrical devices and wiring. EMC noise solution parts such as noise filters and toroidal type ferrite cores may be required in some cases.
- Validation test of drivers was performed as per Low-Voltage and EMC Directives at TÜV (TÜV product service) for self-declaration of CE marking.
- Drivers can be purchased not only as a set but also as a single item. Connector-type drivers are also available. Contact us for details.

Driver Part Names and Functions

Unipolar

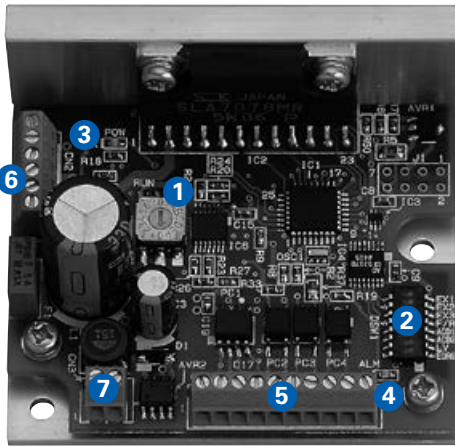

Bipolar

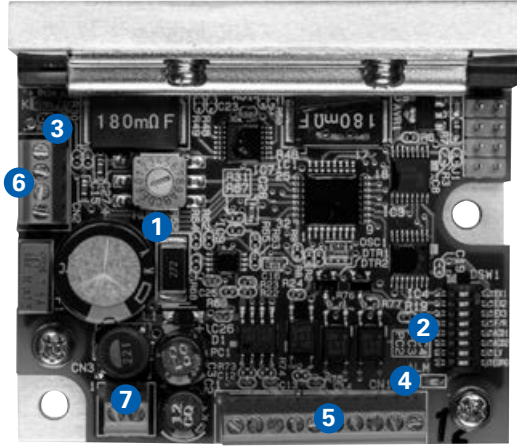

1 Operating current selection switch (RUN)

The value of the motor operating current can be set with a rotary switch.

Dial	0	1	2	3	4	5	6	7
Motor current (A)	2.0	1.9	1.8	1.7	1.6	1.5	1.4	1.3
Dial	8	9	A	B	C	D	E	F
Motor current (A)	1.2	1.1	1.0	0.9	0.8	0.7	0.6	0.5

• The factory setting is F (0.5 A). Select the operating current after checking the rated current of the combination motor.

2 Function selection DIP switchpack

Functions can be selected to suit your application.

Factory settings

	OFF	ON	
EX1	<input type="checkbox"/>	<input type="checkbox"/>	8 subdivisions
EX2	<input type="checkbox"/>	<input type="checkbox"/>	
EX3	<input type="checkbox"/>	<input type="checkbox"/>	
F/R	<input type="checkbox"/>	<input type="checkbox"/>	2-input mode (CW, CCW pulse input)
ACD1	<input type="checkbox"/>	<input type="checkbox"/>	Current at rest: 40% of driving current
ACD2	<input type="checkbox"/>	<input type="checkbox"/>	
LV	<input type="checkbox"/>	<input type="checkbox"/>	Microstepping
EORG	<input type="checkbox"/>	<input type="checkbox"/>	Phase origin

1. Step angle selection (EX1, EX2, EX3)

Number of full step angle subdivisions can be selected.

EX1	EX2	EX3	Microsteps
ON	ON	ON	1 subdivision
OFF	ON	OFF	2 subdivisions
ON	OFF	OFF	4 subdivisions
OFF	OFF	OFF	8 subdivisions
OFF	OFF	ON	16 subdivisions

2. Input mode selection (F/R)

Input pulse mode can be selected.

F/R	Input pulse mode
ON	1-input mode (CK, U/D)
OFF	2-input mode (CW, CCW)

3. Current selection when stopping (ACD1, ACD2)

Select the current value of the motor when stopping.

ACD2	ACD1	Motor current
ON	ON	100% of driving current
ON	OFF	60% of driving current
OFF	ON	50% of driving current
OFF	OFF	40% of driving current

• Initial factory setting is 40% of the rated value. Driver and motor should be operated at around 50% of rated value to reduce heat.

4. Low vibration mode select (LV)

Motors can smoothly operate even at low resolution settings such as full-step (1 subdivision) and half-step (2 subdivisions) modes.

LV	Initial excitation phase
ON	Low vibration
OFF	Microstepping

5. Excitation selection (EORG)

The excitation phase at the time of power activation is selected.

EORG	Initial excitation phase
ON	Excitation phase at power shutdown
OFF	Phase origin

• By turning on EORG, the excitation phase at the time of power shutdown will be saved. Therefore, there will be no shaft displacement when the power is turned on next time.

3 Power supply monitoring LED (POW)

Lights up when the main circuit power supply is turned on.

4 Alarm indicator LED (ALM)

The LED lights up in either of the followings:

- Motor cable is damaged
- The switching device in the driver is damaged
- The main circuit power supply voltage is outside the specification range (below 19 VDC).

When "ALM" is lit, the winding current of the stepping motor is cut off and the status will shift to a "non-excitation" state. At the same time, an output signal (photocoupler ON) is transmitted from the alarm output terminal (AL) to outside. When the alarm circuit is activated, this state is maintained until it is reset by turning on the power supply again. When an alarm goes off, please take corrective actions to eliminate the cause of the alarm before turning on the power supply again.

5 I/O signal terminals (CN1)

For input/output signal connections.

6 Motor connection terminals (CN2)

For motor power connection.

7 Power supply connection terminals (CN3)

For main circuit power supply connection.

Connections and Signals

External wiring diagram

Unipolar

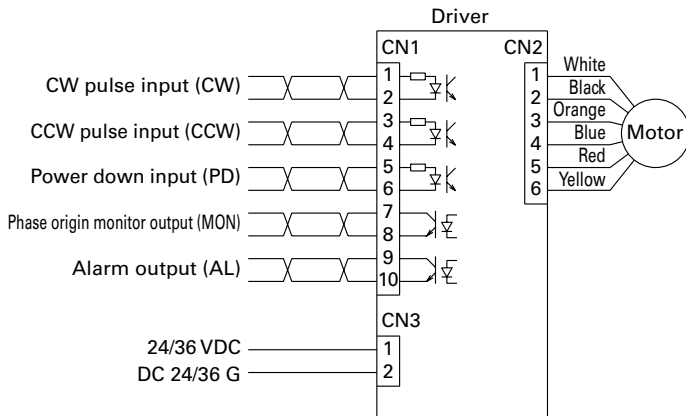

Bipolar

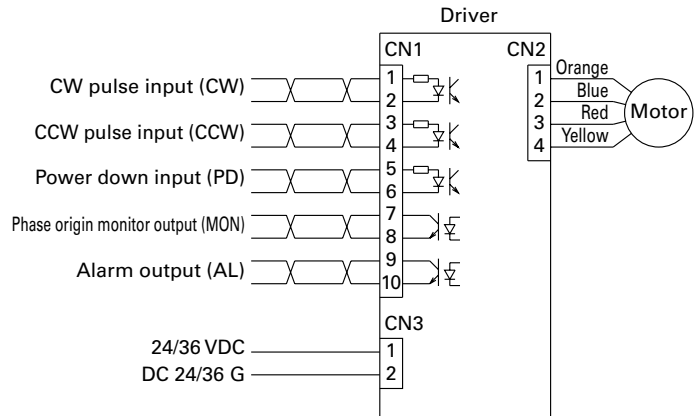

Cable size

Type	Cable Size	Maximum length
Power cable	22 AWG (0.3 mm ²)	2 m or less
I/O signal cable	24 AWG (0.2 mm ²) to 22 AWG (0.3 mm ²)	2 m or less
Motor cable	22 AWG (0.3 mm ²)	Below 3 m

Input/output signal specification overview

Signal	CN1 Pin no.	Function overview
CW pulse input (CW) (Standard)	1 2	When in 2-input mode, a CW-direction pulse is input.
Drive pulse input (CK)	1 2	When in 1-input mode, a drive pulse is input to rotate the motor.
CCW pulse input (CCW) (Standard)	3 4	When in 2-input mode, a CCW-direction pulse is input.
Rotational direction input (U/D)	3 4	When in 1-input mode, a drive pulse is input to designate the rotational direction. Internal photocoupler ON ... CW direction Internal photocoupler OFF ... CCW direction
Power down input (PD)	5 6	A PD signal input will cut off (power off) the current flowing to the motor. PD input signal on (internal photocoupler on) ... PD function is enabled. PD input signal off (internal photocoupler off) ... PD function is disabled.
Phase origin monitor output (MON)	7 8	Turned on when the excitation phase is at the origin (when power is turned on). In full step mode, turned on once for 4 pulses. In half step mode, turned on once for 8 pulses.
Alarm output (AL)	9 10	When the alarm circuit is activated inside the driver, an alarm signal (photocoupler on) is output to outside, which turns the stepping motor to non-excited state.

Note: The CW direction refers to the clockwise direction when the motor is viewed from the output shaft side.

The CCW direction refers to the counter-clockwise direction when the motor is viewed from the output shaft side.

Circuit Configuration of Pulse Input CW (CK), CCW (U/D)

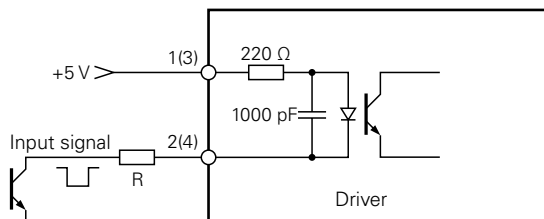

- Ensure that the pulse duty is 50% or less.
- Maximum starting pulse rate is 150 pulses/s.
- If the peak voltage of the input signal exceeds 5.5 V, add an external current-limiting resistor R to limit the input current to around 15 mA. (Take the photocoupler forward voltage of 1.5 V into consideration.)

Input signal specifications

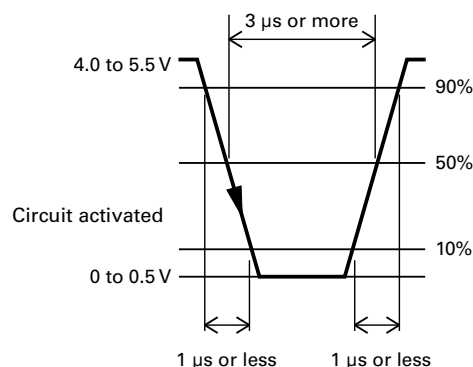

Command pulse timing

2-input mode (CW, CCW)

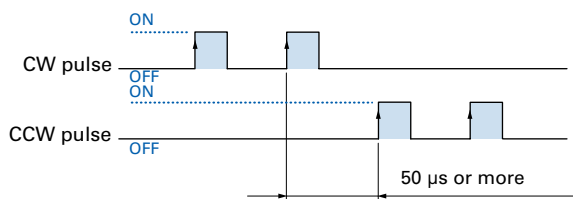

- Shaded areas indicate that internal photocoupler is ON. Internal circuit (motor) starts operating at leading edge of the photocoupler ON.
- When applying a pulse to CW, set the CCW side internal photocoupler to OFF.
- When applying a pulse to CCW, set the CW side internal photocoupler to OFF.

1-input mode (CK, U/D)

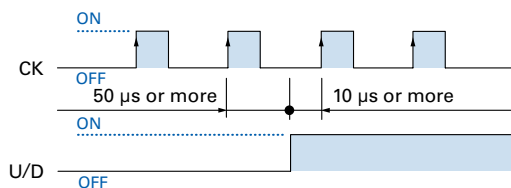

- Shaded areas indicate that internal photocoupler is ON. Internal circuit (motor) starts operating at leading edge of the CK-side photocoupler ON.
- Switching of U/D input signal must be done while the CK-side internal photocoupler is OFF.

Circuit Configuration of Power Down (PD) Input

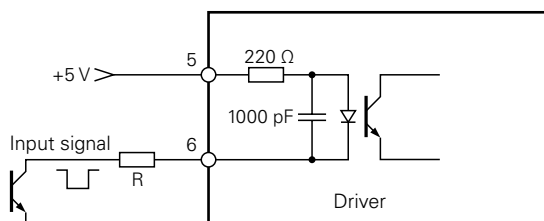

- If the peak voltage of the input signal exceeds 5.5 V, add an external current-limiting resistor R to limit the input current to around 15 mA. (Take the photocoupler forward voltage of 1.5 V into consideration.)

Circuit Configuration of Phase Origin Monitor Output (MON) and Alarm Output (AL)

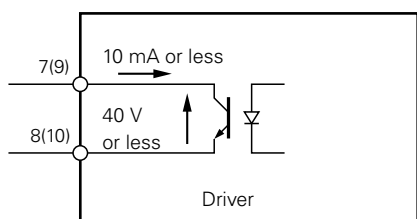

MON output

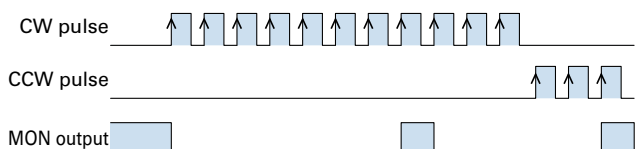

- Photo coupler is turned on when the motor's excitation phase is at the origin (when power is turned on).
- MON output is output every 7.2° rotation of the motor output shaft from the phase origin. (The figure on the left is for when the step angle setting is in a half-step mode)

Stepping Motors (Single Items)

Stepping Motors

▶ p. 36–

IP65-Rated Stepping Motors

Water and dust protection

▶ p. 72–

In-Vacuum Stepping Motors

Custom product

▶ p. 77

Synchronous Motors

Custom product

▶ p. 77

How to Read Specifications

Bipolar, lead type

1 Model no.	2 Holding torque at 2-phase excitation		3 Rated current	4 Winding resistance	5 Winding inductance	6 Rotor inertia	7 Mass	8 Motor length (L)
	Single shaft	Dual shaft	N·m or more	A/phase	Ω/phase	mH/phase	× 10 ⁻⁴ kg·m ²	kg
SH2141-5541	SH2141-5511	0.0065	0.3	21	4.2	0.00058	0.03	30
SH2145-5641	SH2145-5611	0.01	0.4	19	4	0.0011	0.042	43.8

Characteristics

SH2141-5541 SH2141-5511

Constant current circuit
Input voltage: 24 VDC
Winding current:
0.3 A/phase
2-phase excitation (full step)
Pull-out torque:
 $J_L = 0.01 \times 10^{-4} \text{kg}\cdot\text{m}^2$
(Pulley balancer method)
 f_s : Maximum starting pulse
rate with no load

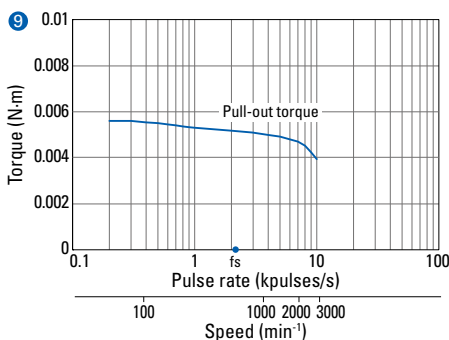

SH2145-5641 SH2145-5611

Constant current circuit
Input voltage: 24 VDC
Winding current:
0.4 A/phase
At 2-phase excitation (full step)
Pull-out torque:
 $J_L = 0.01 \times 10^{-4} \text{kg}\cdot\text{m}^2$
(Pulley balancer method)
 f_s : Maximum starting pulse
rate with no load

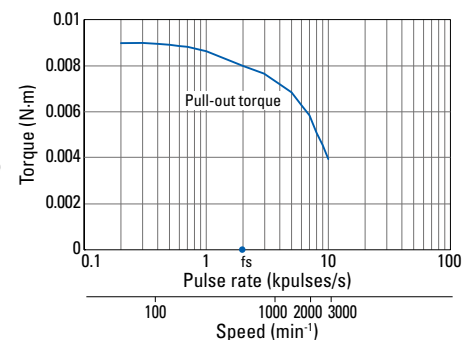

- This is the model number of the stepping motor.
- This is the maximum torque that is generated when the stepping motor is rotated by exerting an external force on the shaft at 2-phase excitation at the rated current.
- This is the rated current that flows to the motor winding. When current of this value flows through a motor, the torque generated will be the same as the holding torque.
- This is the resistance for one phase of stepping motor winding.

- This is the inductance for one phase of stepping motor winding.
- This is the moment of inertia of the rotor. This indicates the degree of ease with which the rotor accelerates or decelerates.
- This is the mass of the stepping motor.
- This is the length of the stepping motor.
- This graph shows the relationship between the pulse rate (frequency), motor speed, and pull-out torque in a full-step mode.

Lineup

Stepping Motors RoHS

These motors can be purchased as a single item.



Full step angle	Motor size	Holding torque [N·m] Model no.	Custom options *	Page
1.8°	14 mm sq. Ultra-compact	0.0065 to 0.01 SH214□-5□□1	Hollow shaft Custom shaft	p. 36
	28 mm sq.	0.055 to 0.145 SH228□-5□□1	Hollow shaft Custom shaft Gear Encoder	p. 37 to 38
	35 mm sq.	0.12 to 0.32 SH35□□-1□□□0	Hollow shaft Custom shaft	p. 39 to 40
0.9°	42 mm sq.	0.2 to 0.48 SH142□-□□□1	Hollow shaft Custom shaft Gear Encoder	p. 41 to 42
1.8°	42 mm sq. Thin-profile	0.083 to 0.186 SS242□-50□□□	Hollow shaft Custom shaft Encoder	p. 43
	42 mm sq.	0.22 to 0.8 SF242□-1□□□1	Custom shaft Gear Encoder Brake	p. 44 to 45
	50 mm sq.	0.28 to 0.53 103H670□-□□□0	Hollow shaft Custom shaft Encoder	p. 46 to 48
	50 mm sq. Thin-profile	0.1 to 0.215 SS250□-80□□0	Hollow shaft Custom shaft	p. 49
	56 mm sq. UL models	0.53 to 2.5 SM256□C□0□□1	Hollow shaft Custom shaft Gear Encoder Brake	p. 50 to 55
	60 mm sq.	It is recommended you use a 56 mm sq. motor (SM256 □ C □ 0 □ □ 1).		
0.9°	60 mm sq.	0.57 to 2.15 SH160□-□□□0	Hollow shaft Custom shaft Gear Encoder	p. 56 to 57
1.8°	86 mm sq.	2.5 to 9 SH286□-□□□1	Hollow shaft Custom shaft Encoder Brake	p. 58 to 61

* Custom options vary depending on the model number and quantity. Contact us for details.

Full step angle	Motor size	Holding torque [N·m] Model no.	Custom options *	Page
1.8°	 ∅106 mm	10.8 to 19 103H8922□-□□□1	Hollow shaft Custom shaft Brake	p. 62
	 56 mm sq. CE models	0.39 to 1.27 103H712□-6□□0	Hollow shaft Custom shaft	p. 63
	 86 mm sq. CE/UL models	2.5 to 9 SM286□-□□□□	Hollow shaft Custom shaft	p. 64 to 67
	 ∅106 mm CE models	13.2 to 19 103H8922□-63□1	Hollow shaft Custom shaft	p. 68

* Custom options vary depending on the model number and quantity. Contact us for details.

IP65-Rated Stepping Motors Water and dust protection RoHS

Fundamental frequency Step angle	Motor size	Holding torque [N·m] Model no.	Custom options *	Page
1.8°	 56 mm sq. CE/UL models	1 to 1.7 SP256□-5□□0	Custom shaft	p. 73 to 74
	 86 mm sq. CE/UL models	3.3 to 9 SP286□-5□□0	Custom shaft	p. 75 to 76

In-Vacuum Stepping Motors Custom product

Motor size	Page
 42 mm sq. to ∅106 mm	p. 77

Synchronous Motors Custom product

Motor size	Page
 56 mm sq. to ∅106 mm	p. 77

Customization Services

Custom options availability varies depending on the requested customization and quantity. Contact us for details.

Custom examples

Custom harness

Connectors, cable ties, and plastic tubing can be added.

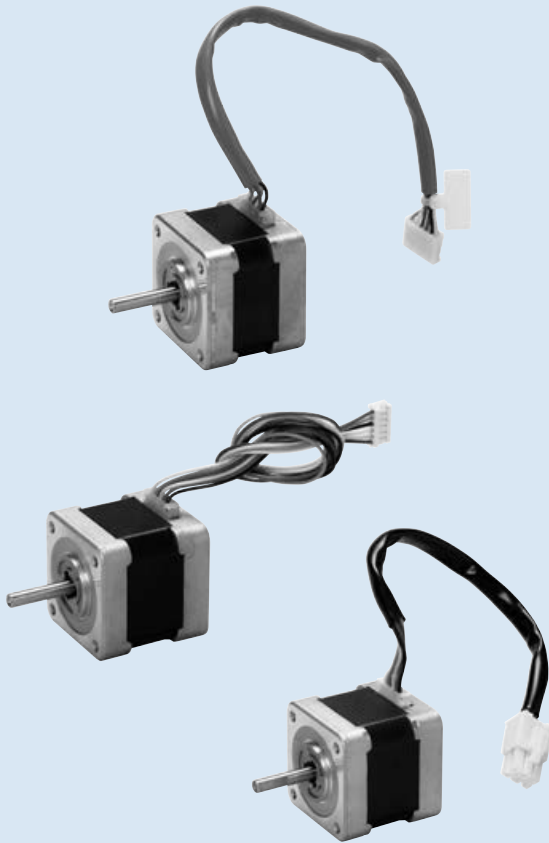

Custom shaft

We also offer custom options such as D-shaped shaft, addition of keyway and through-holes, and mounting of gear and pulley. The shaft can be made a hollow shaft for routing cables and air.

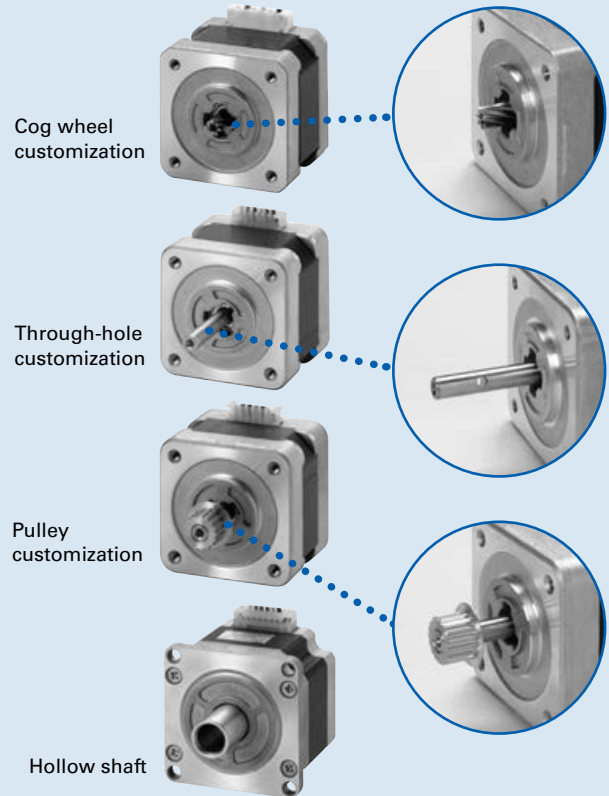

Rotary damper and surface mount damper

A damper can be added to reduce vibrations when rotating.



Rotary damper



Surface mount damper

Gears, encoders, and brake

- A gear can be added for applications where a high load torque is exerted at low speeds.
- An encoder can be added for detecting motor position and speed.
- A brake can be added to hold the motor position at rest.



With encoder



With gear

Geared Motors Applicable motor size: 56 mm sq. Model: S□2561

Low backlash gear model

These models feature low-backlash gear.

Allowable torque	N·m	1.25	2.5	3	3.5	4	4
Gear ratio	—	1:3.6	1:7.2	1:10	1:20	1:30	1:36
Backlash	° or less	0.55	0.25	0.25	0.17	0.17	0.17
Allowable speed	min ⁻¹	500	250	180	90	60	50
Allowable thrust load	N	30	30	30	30	30	30
Allowable radial load*	N	100	100	100	100	100	100

* Load is exerted on the point 1/3 the shaft length from the shaft end.

Note: The motor and shaft rotate in the same direction for 1:3.6 and 1:7.2 gear ratios and in opposite directions for 1:10, 1:20, 1:30, 1:36 gear ratios.

Harmonic gear model

This model has extremely low backlash and superb positioning precision. The lineup has high gear ratios of up to 1:100 available.

Allowable torque	N·m	5.5	8
Peak torque	N·m	14	20
Gear ratio	—	1:50	1:100
Lost motion	arcmin	0.4 to 3 (at ±0.28 N·m)	0.4 to 1.5 (at ±0.4 N·m)
Allowable speed	min ⁻¹	70	35
Maximum allowable speed	min ⁻¹	100	50
Allowable thrust load	N	400	400
Allowable radial load*	N	360	360

* Load is exerted on the point 1/3 the shaft length from the shaft end.

Note: The motor shaft and the gear output shaft rotate in the opposite directions.

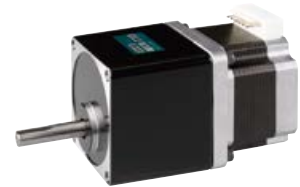

Electromagnetic brake models Compatible motors: 56 mm sq. Model no. SF256□ Note: Non-UL certified

The non-excitation electromagnetic brake holds a workpiece when power is lost, preventing it from falling.

Brake activation type	—	Non-excitation type
Input voltage	—	24 VDC ± 5%
Power consumption	W	6 (at 75° C)
Static friction torque	N·m or more	0.8
Polarity	—	Red: +, black: -



Models with encoder Compatible motors: 56 mm sq. Model no. SF256□

This model can detect vibration and step-out by monitoring the motor's operation status such as position and speed.

Microsteps	P/R	1000	2000	4000
Number of channels	Ch	3	3	3
Output circuit	—	Line driver (CMOS)		
Maximum response frequency	kHz	55	110	220
Input voltage	—	5 V ±5%	5 V ±5%	5 V ±5%
Current consumption	mA or less	100	100	100



Contact us for information on motors other than 56 mm sq. motors.

Stepping Motors

Allowable loads... ▶p. 69
 Internal wiring and rotational directions... ▶p. 70
 General specifications... ▶p. 71



14 mm sq.

1.8°/step **Ultra-compact** **RoHS**
 Bipolar, lead type



Custom options

Hollow shaft **Custom shaft**

Note: Customization feasibility depends on the model number and quantity. Contact us for details.

Bipolar, lead type

Model no.		Holding torque at 2-phase excitation	Rated current	Winding resistance	Winding inductance	Rotor inertia	Mass	Motor length (L)
Single shaft	Dual shaft	N·m or more	A/phase	Ω/phase	mH/phase	×10 ⁻⁴ kg·m ²	kg	mm
SH2141-5541	SH2141-5511	0.0065	0.3	21	4.2	0.00058	0.03	30
SH2145-5641	SH2145-5611	0.01	0.4	19	4	0.0011	0.042	43.8

Characteristics

SH2141-5541
SH2141-5511

Constant current circuit
 Input voltage: 24 VDC
 Winding current: 0.3 A/phase
 2-phase (full step)
 Pull-out torque:
 $J_L = 0.01 \times 10^{-4} \text{kg}\cdot\text{m}^2$
 (Pulley balancer method)
 fs: Maximum starting pulse rate with no load

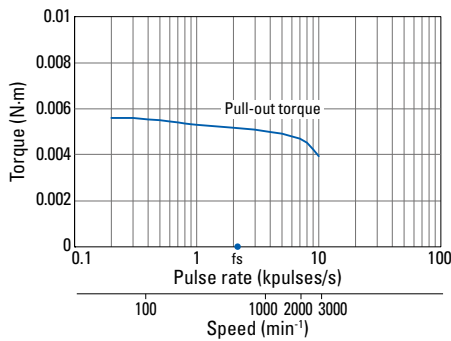

SH2145-5641
SH2145-5611

Constant current circuit
 Input voltage: 24 VDC
 Winding current: 0.4 A/phase
 At 2-phase excitation (full step)
 Pull-out torque:
 $J_L = 0.01 \times 10^{-4} \text{kg}\cdot\text{m}^2$
 (Pulley balancer method)
 fs: Maximum starting pulse rate with no load

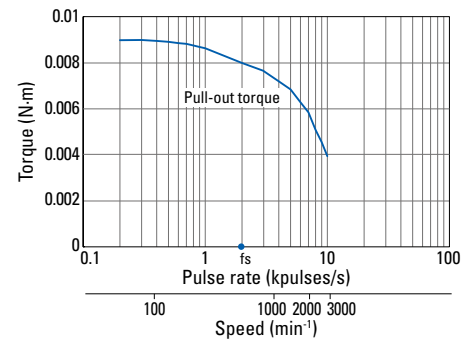

Dimensions (Unit: mm)

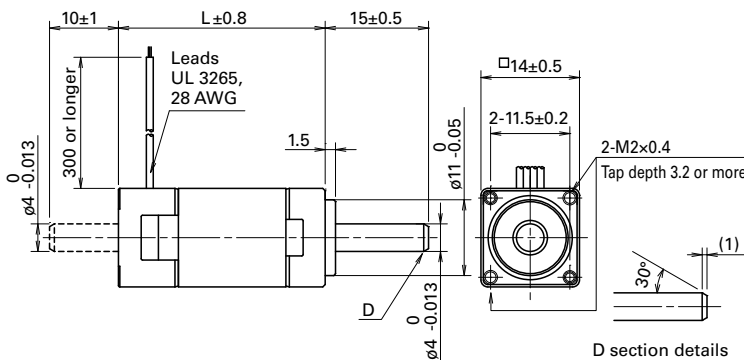

Internal winding

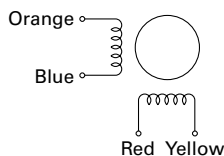

Compatible drivers

A driver is to be provided by the customer.



28 mm sq.

1.8°/step **RoHS**

Unipolar, lead type
Bipolar, lead type ▶ p. 38



Custom options

- Hollow shaft Custom shaft
- Gear Encoder

Note: Customization feasibility depends on the model number and quantity. Contact us for details.

Unipolar, lead type

Model no.		Holding torque at 2-phase excitation	Rated current	Winding resistance	Winding inductance	Rotor inertia	Mass	Motor length (L)
Single shaft	Dual shaft	N·m or more	A/phase	Ω/phase	mH/phase	×10 ⁻⁴ kg·m ²	kg	mm
SH2281-5171	SH2281-5131	0.055	0.5	10.5	3.7	0.01	0.11	32
SH2281-5271	SH2281-5231	0.055	1	2.85	1	0.01	0.11	32
SH2285-5171	SH2285-5131	0.115	0.5	17	7	0.022	0.2	51.5
SH2285-5271	SH2285-5231	0.115	1	4.1	1.9	0.022	0.2	51.5

Characteristics

SH2281-5171 SH2281-5131

Constant current circuit
Input voltage: 24VDC
Winding current: 0.5 A/phase
At 2-phase excitation (full step)
Pull-out torque:
 $J_L = 0.01 \times 10^{-4} \text{kg}\cdot\text{m}^2$
(Pulley balancer method)
fs: Maximum starting pulse rate with no load

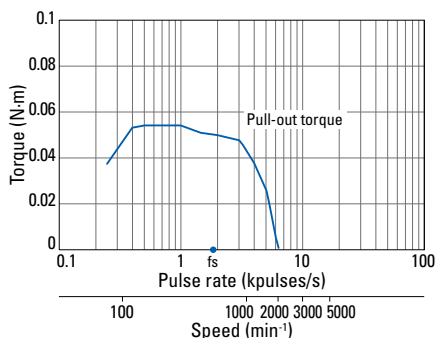

SH2281-5271 SH2281-5231

Constant current circuit
Input voltage: 24VDC
Winding current: 1 A/phase
At 2-phase excitation (full step)
Pull-out torque:
 $J_L = 0.01 \times 10^{-4} \text{kg}\cdot\text{m}^2$
(Pulley balancer method)
fs: Maximum starting pulse rate with no load

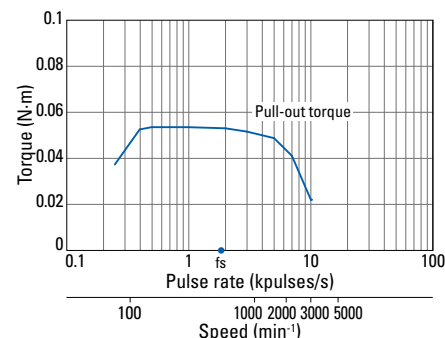

SH2285-5171 SH2285-5131

Constant current circuit
Input voltage: 24VDC
Winding current: 0.5 A/phase
At 2-phase excitation (full step)
Pull-out torque:
 $J_L = 0.01 \times 10^{-4} \text{kg}\cdot\text{m}^2$
(Pulley balancer method)
fs: Maximum starting pulse rate with no load

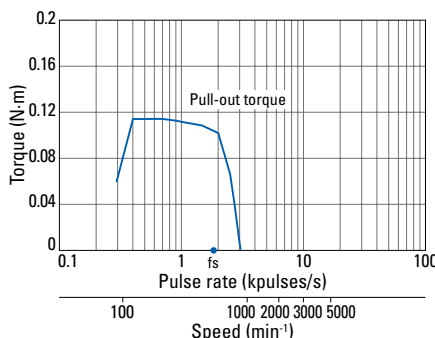

SH2285-5271 SH2285-5231

Constant current circuit
Input voltage: 24VDC
Winding current: 1 A/phase
At 2-phase excitation (full step)
Pull-out torque:
 $J_L = 0.01 \times 10^{-4} \text{kg}\cdot\text{m}^2$
(Pulley balancer method)
fs: Maximum starting pulse rate with no load

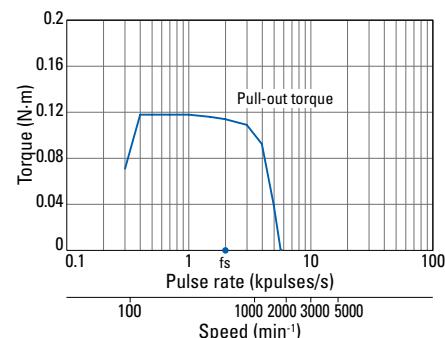

Dimensions (Unit: mm)

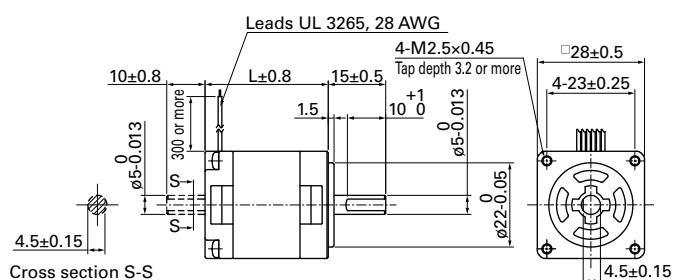

Internal winding

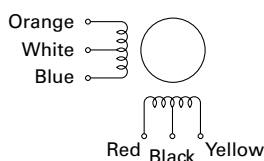

Compatible drivers

- For motors SH228 □ -52 □ 1 (1 A/phase)...
Model no.: US1D200P10 (DC input)
Operating current selection switch setting: A
- For motors other than above...
A driver is to be provided by the customer.

Note: The characteristics shown above are calculated using our experimental circuit.



28 mm sq.

1.8°/step **RoHS**

Bipolar, lead type
Unipolar, lead type ▶ p. 37



Custom options

- Hollow shaft | Custom shaft
- Gear | Encoder

Note: Customization feasibility depends on the model number and quantity. Contact us for details.

Bipolar, lead type

Model no.		Holding torque at 2-phase excitation	Rated current	Winding resistance	Winding inductance	Rotor inertia	Mass	Motor length (L)
Single shaft	Dual shaft	N·m or more	A/phase	Ω/phase	mH/phase	×10 ⁻⁴ kg·m ²	kg	mm
SH2281-5671	SH2281-5631	0.07	0.5	10.5	7.2	0.01	0.11	32
SH2281-5771	SH2281-5731	0.07	1	2.6	1.85	0.01	0.11	32
SH2285-5671	SH2285-5631	0.145	0.5	15	13.5	0.022	0.2	51.5
SH2285-5771	SH2285-5731	0.145	1	3.75	3.4	0.022	0.2	51.5

Characteristics

SH2281-5671 SH2281-5631

Constant current circuit
Input voltage: 24VDC
Winding current:
0.5 A/phase
At 2-phase excitation (full step)
Pull-out torque:
 $J_L = 0.01 \times 10^{-4} \text{kg}\cdot\text{m}^2$
(Pulley balancer method)
 f_s : Maximum starting pulse rate with no load

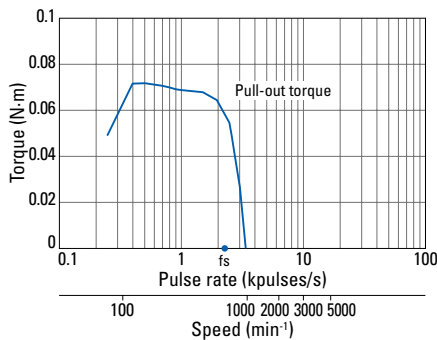

SH2281-5771 SH2281-5731

Constant current circuit
Input voltage: 24VDC
Winding current:
1 A/phase
At 2-phase excitation (full step)
Pull-out torque:
 $J_L = 0.01 \times 10^{-4} \text{kg}\cdot\text{m}^2$
(Pulley balancer method)
 f_s : Maximum starting pulse rate with no load

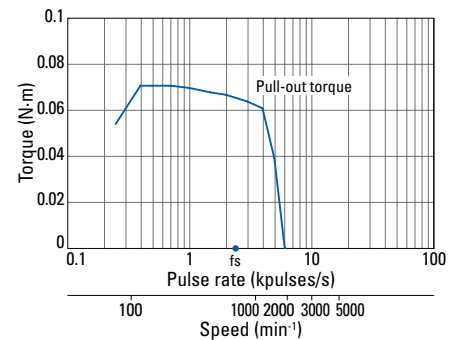

SH2285-5671 SH2285-5631

Constant current circuit
Input voltage: 24VDC
Winding current:
0.5 A/phase
At 2-phase excitation (full step)
Pull-out torque:
 $J_L = 0.01 \times 10^{-4} \text{kg}\cdot\text{m}^2$
(Pulley balancer method)
 f_s : Maximum starting pulse rate with no load

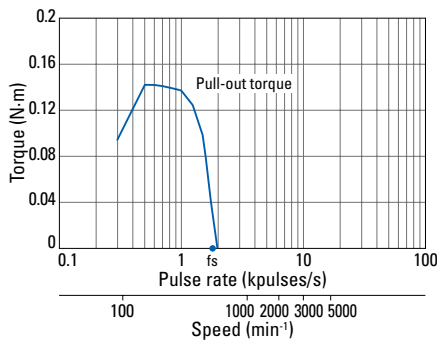

SH2285-5771 SH2285-5731

Constant current circuit
Input voltage: 24VDC
Winding current:
1 A/phase
At 2-phase excitation (full step)
Pull-out torque:
 $J_L = 0.01 \times 10^{-4} \text{kg}\cdot\text{m}^2$
(Pulley balancer method)
 f_s : Maximum starting pulse rate with no load

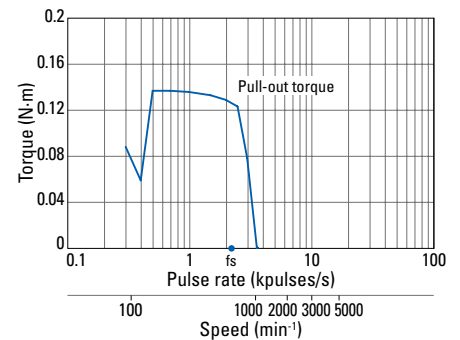

Dimensions (Unit: mm)

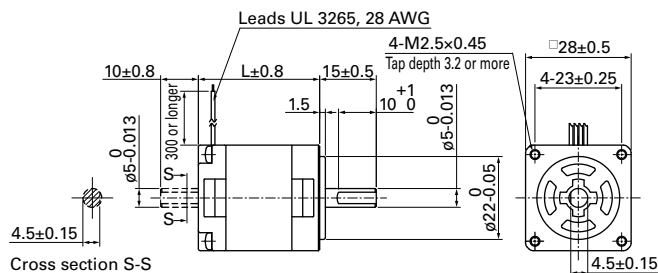

Internal winding

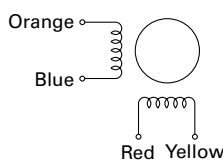

Compatible drivers

- For motors SH228 □ -57 □ 1 (1 A/phase)...
Model no.: BS1D200P10 (DC input)
Operating current selection switch setting: A
- For motors other than above...
A driver is to be provided by the customer.

Note: The characteristics shown above are calculated using our experimental circuit.

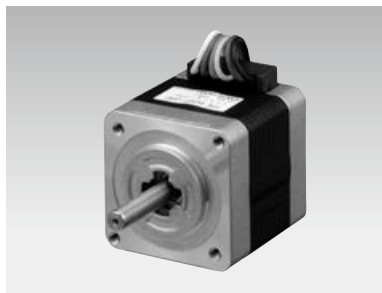

35 mm sq.

1.8°/step **RoHS**

Unipolar, lead type

Custom options

Hollow shaft **Custom shaft**

Note: Customization feasibility depends on the model number and quantity. Contact us for details.

Unipolar, lead type

Model no.		Holding torque at 2-phase excitation	Rated current	Winding resistance	Winding inductance	Rotor inertia	Mass	Motor length (L)
Single shaft	Dual shaft	N·m or more	A/phase	Ω/phase	mH/phase	×10 ⁻⁴ kg·m ²	kg	mm
SH3533-12U40	SH3533-12U10	0.12	1.2	2.4	1.3	0.02	0.17	33
SH3537-12U40	SH3537-12U10	0.15	1.2	2.7	2	0.025	0.2	37
SH3552-12U40	SH3552-12U10	0.23	1.2	3.4	2.8	0.043	0.3	52

Characteristics

SH3533-12U40 SH3533-12U10

Constant current circuit
Input voltage: 24 VDC
Winding current: 1.2 A/phase
At 2-phase excitation (full step)
Pull-out torque:
 $J_L = 0.33 \times 10^{-4} \text{kg}\cdot\text{m}^2$
(with rubber coupling used)
 f_s : Maximum starting pulse rate with no load

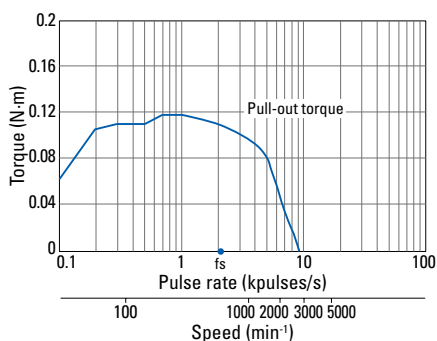

SH3537-12U40 SH3537-12U10

Constant current circuit
Input voltage: 24 VDC
Winding current: 1.2 A/phase
At 2-phase excitation (full step)
Pull-out torque:
 $J_L = 0.33 \times 10^{-4} \text{kg}\cdot\text{m}^2$
(with rubber coupling used)
 f_s : Maximum starting pulse rate with no load

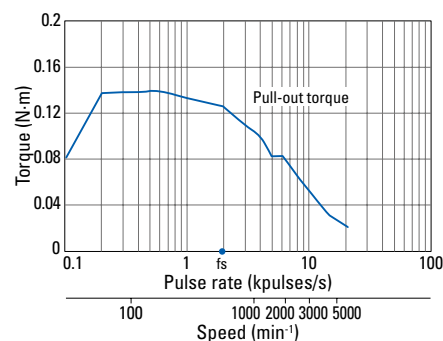

SH3552-12U40 SH3552-12U10

Constant current circuit
Input voltage: 24 VDC
Winding current: 1.2 A/phase
At 2-phase excitation (full step)
Pull-out torque:
 $J_L = 0.94 \times 10^{-4} \text{kg}\cdot\text{m}^2$
(with rubber coupling used)
 f_s : Maximum starting pulse rate with no load

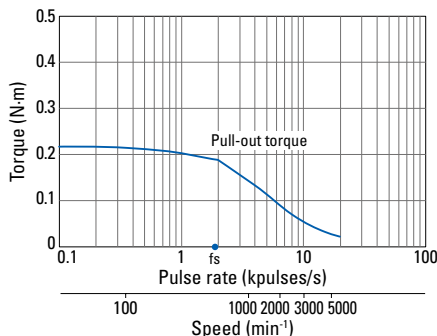

Dimensions (Unit: mm)

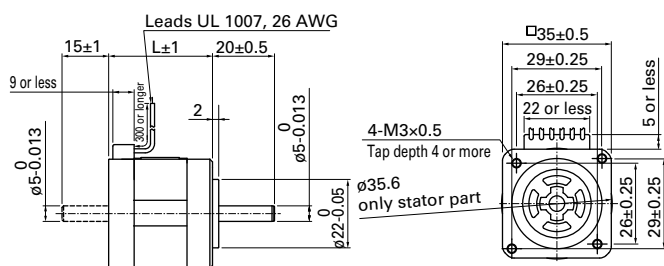

Internal winding

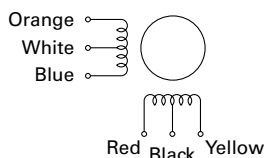

Compatible drivers

Model no.: US1D200P10 (DC input)

Operating current selection switch setting: 8

Note: The characteristics shown above are calculated using our experimental circuit.



Note: The photo shows a unipolar motor.

42 mm sq.

0.9°/step **RoHS**
Bipolar, lead type



Custom options

- Hollow shaft
- Custom shaft
- Gear
- Encoder

Note: Customization feasibility depends on the model number and quantity. Contact us for details.

Bipolar, lead type

Model no.		Holding torque at 2-phase excitation	Rated current	Winding resistance	Winding inductance	Rotor inertia	Mass	Motor length (L)
Single shaft	Dual shaft	N·m or more	A/phase	Ω/phase	mH/phase	×10 ⁻⁴ kg·m ²	kg	mm
SH1421-5041	SH1421-5011	0.23	1	3.3	8.0	0.044	0.24	33
SH1421-5241	SH1421-5211	0.23	2	0.85	2.1	0.044	0.24	33
SH1422-5041	SH1422-5011	0.34	1	4.0	14.0	0.066	0.29	39
SH1422-5241	SH1422-5211	0.34	2	1.05	3.6	0.066	0.29	39
SH1424-5041	SH1424-5011	0.48	1	4.7	15.0	0.089	0.38	48
SH1424-5241	SH1424-5211	0.48	2	1.25	3.75	0.089	0.38	48

Characteristics

SH1421-5041 SH1421-5011

Constant current circuit
Input voltage: 24 VDC
Winding current:
1 A/phase
At 2-phase excitation (full step)
Pull-out torque:
 $J_L = 0.94 \times 10^{-4} \text{kg}\cdot\text{m}^2$
(with rubber coupling used)
 f_s : Maximum starting pulse rate with no load

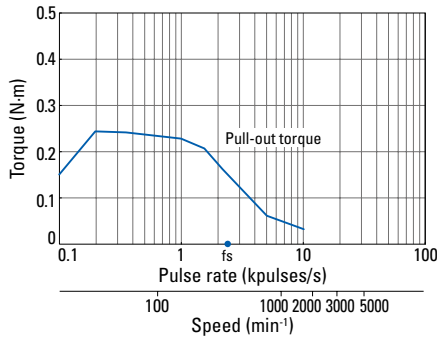

SH1421-5241 SH1421-5211

Constant current circuit
Input voltage: 24 VDC
Winding current:
2 A/phase
At 2-phase excitation (full step)
Pull-out torque:
 $J_L = 0.94 \times 10^{-4} \text{kg}\cdot\text{m}^2$
(with rubber coupling used)
 f_s : Maximum starting pulse rate with no load

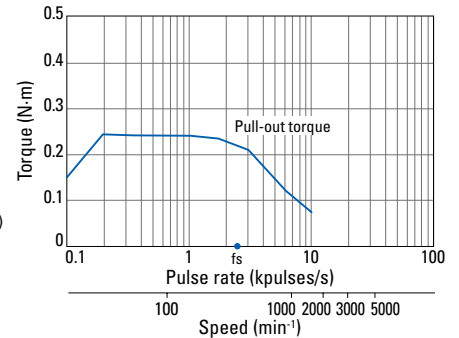

SH1422-5041 SH1422-5011

Constant current circuit
Input voltage: 24 VDC
Winding current:
1 A/phase
At 2-phase excitation (full step)
Pull-out torque:
 $J_L = 0.94 \times 10^{-4} \text{kg}\cdot\text{m}^2$
(with rubber coupling used)
 f_s : Maximum starting pulse rate with no load

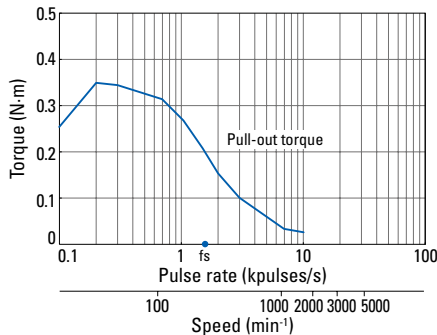

SH1422-5241 SH1422-5211

Constant current circuit
Input voltage: 24 VDC
Winding current:
2 A/phase
At 2-phase excitation (full step)
Pull-out torque:
 $J_L = 0.94 \times 10^{-4} \text{kg}\cdot\text{m}^2$
(with rubber coupling used)
 f_s : Maximum starting pulse rate with no load

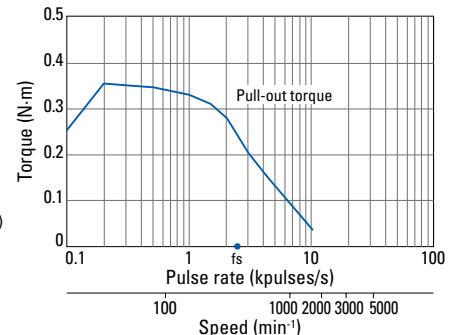

SH1424-5041 SH1424-5011

Constant current circuit
Input voltage: 24 VDC
Winding current:
1 A/phase
At 2-phase excitation (full step)
Pull-out torque:
 $J_L = 0.94 \times 10^{-4} \text{kg}\cdot\text{m}^2$
(with rubber coupling used)
 f_s : Maximum starting pulse rate with no load

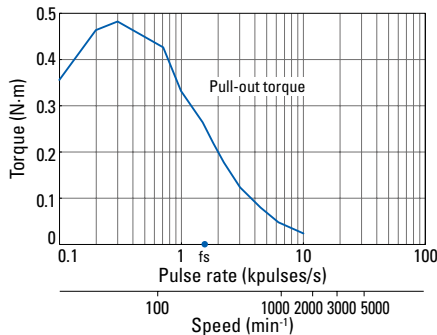

SH1424-5241 SH1424-5211

Constant current circuit
Input voltage: 24 VDC
Winding current:
2 A/phase
At 2-phase excitation (full step)
Pull-out torque:
 $J_L = 0.94 \times 10^{-4} \text{kg}\cdot\text{m}^2$
(with rubber coupling used)
 f_s : Maximum starting pulse rate with no load

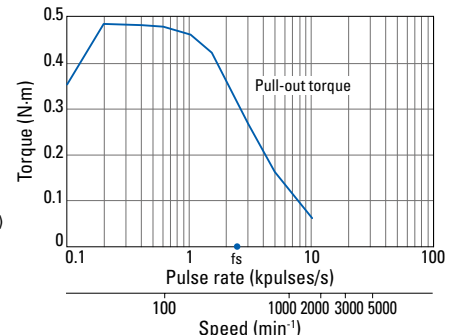

Dimensions (Unit: mm)

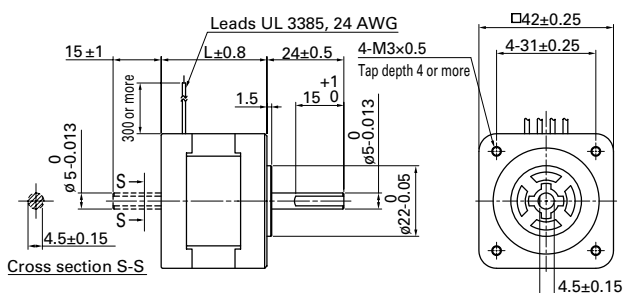

Internal winding

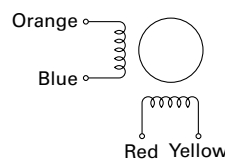

Compatible drivers

- For motors SH142 □ -52 □ 1 (2 A/phase)...
Model no.: BS1D200P10 (DC input)
Operating current selection switch setting: 0
 - For motors SH142 □ -50 □ 1 (1 A/phase)...
Model no.: BS1D200P10 (DC input)
Operating current selection switch setting: A
- Note: The characteristics shown above are calculated using our experimental circuit.

Allowable loads... ▶ p. 69 Internal wiring and rotational directions... ▶ p. 70

General specifications... ▶ p. 71

Data is measured under the drive conditions of SANYO DENKI. Drive torque may vary depending on the actual machine precision.



42 mm sq.

1.8°/step **Thin-profile** **RoHS**
Bipolar, lead type



Custom options

- Hollow shaft Custom shaft
- Encoder

Note: Customization feasibility depends on the model number and quantity. Contact us for details.

Bipolar, lead type Radial load: 10 N

Model no.		Holding torque at 2-phase excitation	Rated current	Winding resistance	Winding inductance	Rotor inertia	Mass	Motor length (L)
Single shaft	Dual shaft	N·m or more	A/phase	Ω/phase	mH/phase	×10 ⁻⁴ kg·m ²	kg	mm
SS2421-5041	SS2421-5011	0.083	1	3.5	1.2	0.015	0.07	11.6
SS2422-5041	SS2422-5011	0.186	1	5.4	2.9	0.028	0.14	18.6

Bipolar, lead type **Heavy duty** Radial load: 25 N

Model no.		Holding torque at 2-phase excitation	Rated current	Winding resistance	Winding inductance	Rotor inertia	Mass	Motor length (L)
Single shaft	Dual shaft	N·m or more	A/phase	Ω/phase	mH/phase	×10 ⁻⁴ kg·m ²	kg	mm
SS2421-50400	SS2421-50100	0.083	1	3.5	1.2	0.015	0.09	14.5
SS2422-50400	SS2422-50100	0.186	1	5.4	2.9	0.028	0.16	21.5

Characteristics

SS2421-5041
SS2421-5011

SS2421-50400
SS2421-50100

Constant current circuit
Input voltage: 24 VDC
Winding current:
1 A/phase
At 2-phase excitation (full step)
Pull-out torque:
 $J_L = 0.33 \times 10^{-4} \text{kg}\cdot\text{m}^2$
(with rubber coupling used)
 f_s : Maximum starting pulse rate with no load

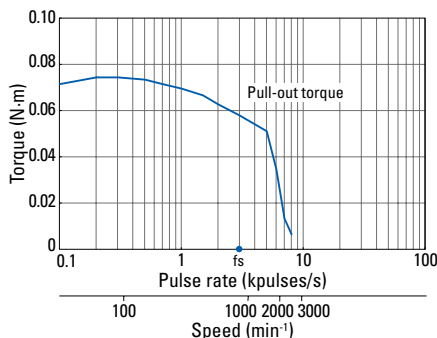

SS2422-5041
SS2422-5011

SS2422-50400
SS2422-50100

Constant current circuit
Input voltage: 24 VDC
Winding current:
1 A/phase
At 2-phase excitation (full step)
Pull-out torque:
 $J_L = 0.33 \times 10^{-4} \text{kg}\cdot\text{m}^2$
(with rubber coupling used)
 f_s : Maximum starting pulse rate with no load

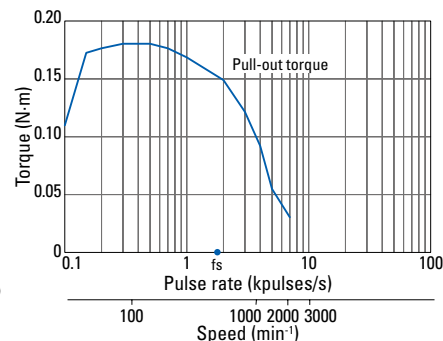

Dimensions (Unit: mm)

Model no.: SS242□-50□□

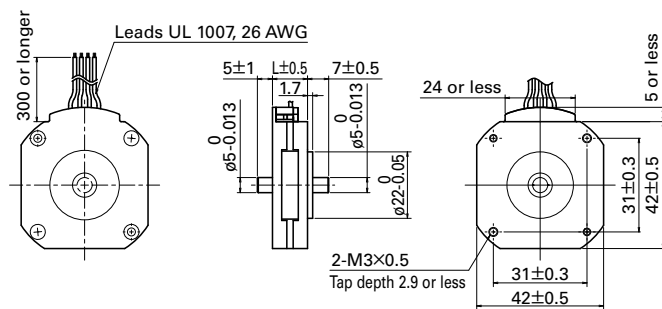

Model no.: SS242□-50□00

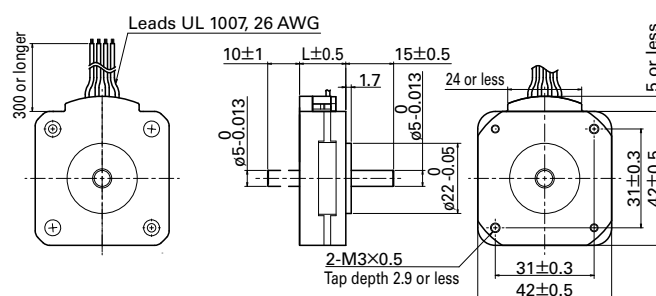

Internal winding

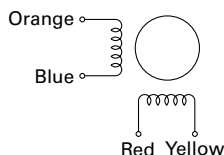

Compatible drivers

Model no.: BS1D200P10 (DC input)

Operating current selection switch setting: A

Note: The characteristics shown above are calculated using our experimental circuit.

Bipolar, connector type

Model no.		Holding torque at 2-phase excitation	Rated current	Winding resistance	Winding inductance	Rotor inertia	Mass	Motor length (L)
Single shaft	Dual shaft	N·m or more	A/phase	Ω/phase	mH/phase	×10 ⁻⁴ kg·m ²	kg	mm
SF2421-10B41	SF2421-10B11	0.29	1	3.6	7	0.031	0.23	33 ± 0.5
SF2422-10B41	SF2422-10B11	0.43	1	4.6	9.6	0.046	0.3	39 ± 0.5
SF2423-10B41	SF2423-10B11	0.56	1	5.3	12.5	0.063	0.38	48 ± 0.5
SF2424-10B41	SF2424-10B11	0.8	1	6.5	16	0.094	0.51	59.5 ± 1

Motor cable model no.: 4835775-1

Characteristics

**SF2421-10B41
SF2421-10B11**

Constant current circuit
Input voltage: 24 VDC
Winding current: 1 A/phase
At 2-phase excitation (full step)
Pull-out torque:
 $J_L = 0.94 \times 10^{-4} \text{kg}\cdot\text{m}^2$
(with rubber coupling used)
 f_s : Maximum starting pulse rate with no load

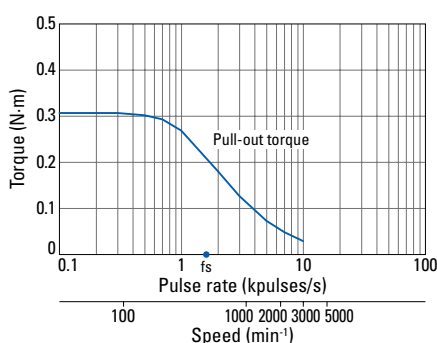

**SF2422-10B41
SF2422-10B11**

Constant current circuit
Input voltage: 24 VDC
Winding current: 1 A/phase
At 2-phase excitation (full step)
Pull-out torque:
 $J_L = 0.94 \times 10^{-4} \text{kg}\cdot\text{m}^2$
(with rubber coupling used)
 f_s : Maximum starting pulse rate with no load

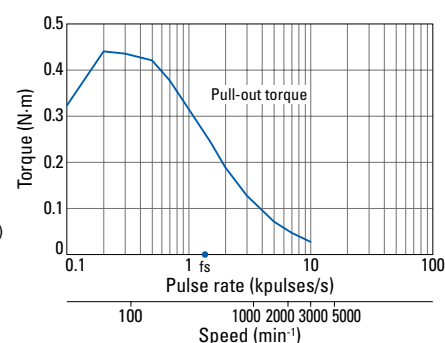

**SF2423-10B41
SF2423-10B11**

Constant current circuit
Input voltage: 24 VDC
Winding current: 1 A/phase
At 2-phase excitation (full step)
Pull-out torque:
 $J_L = 0.94 \times 10^{-4} \text{kg}\cdot\text{m}^2$
(with rubber coupling used)
 f_s : Maximum starting pulse rate with no load

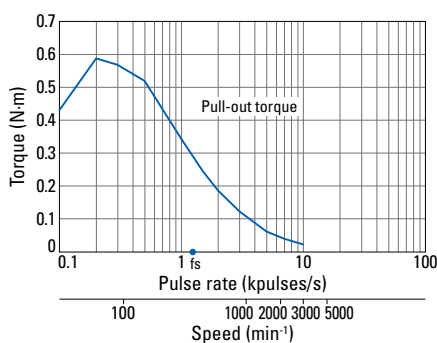

**SF2424-10B41
SF2424-10B11**

Constant current circuit
Input voltage: 24 VDC
Winding current: 1 A/phase
At 2-phase excitation (full step)
Pull-out torque:
 $J_L = 2.6 \times 10^{-4} \text{kg}\cdot\text{m}^2$
(with rubber coupling used)
 f_s : Maximum starting pulse rate with no load

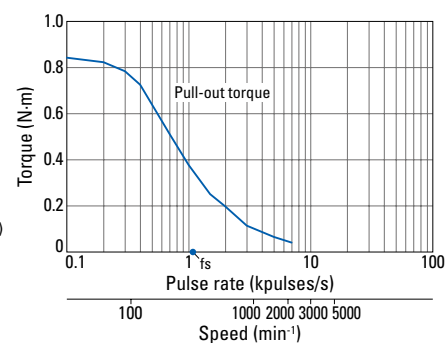

Dimensions (Unit: mm)

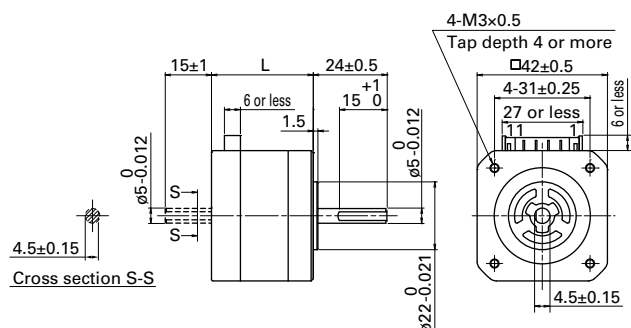

Separate option: Motor cable 4835775-1

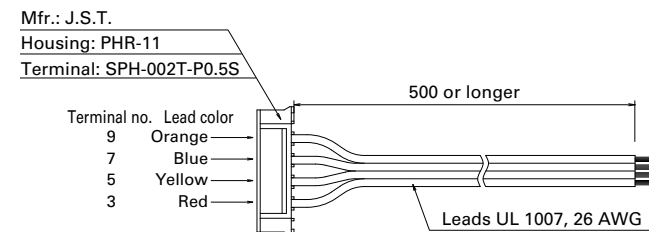

This is a motor cable for model nos. SF242□-10B□1

Internal wiring

In parentheses are connector pin nos.

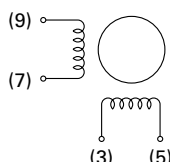

Compatible drivers

Model no.: BS1D200P10 (DC input)

Operating current selection switch setting: A

Note: The characteristics shown above are calculated using our experimental circuit.

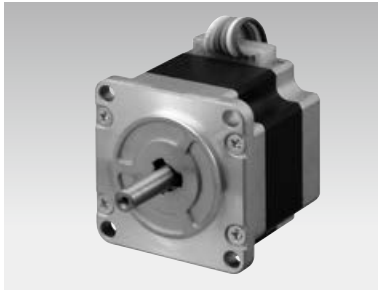

50 mm sq.

1.8°/step RoHS

Unipolar, lead type
Bipolar, lead type ▶ p. 48

Custom options

- Hollow shaft Custom shaft
- Encoder

Note: Customization feasibility depends on the model number and quantity. Contact us for details.

Unipolar, lead type

Model no.		Holding torque at 2-phase excitation	Rated current	Winding resistance	Winding inductance	Rotor inertia	Mass	Motor length (L)
Single shaft	Dual shaft	N·m or more	A/phase	Ω/phase	mH/phase	×10 ⁻⁴ kg·m ²	kg	mm
103H6701-0140	103H6701-0110	0.28	1	4.3	6.8	0.057	0.35	39.8
103H6701-0440	103H6701-0410	0.28	2	1.1	1.6	0.057	0.35	39.8
103H6701-0740	103H6701-0710	0.28	3	0.6	0.7	0.057	0.35	39.8
103H6703-0140	103H6703-0110	0.49	1	6	13	0.118	0.5	51.3
103H6703-0440	103H6703-0410	0.49	2	1.6	3.2	0.118	0.5	51.3
103H6703-0740	103H6703-0710	0.49	3	0.83	1.4	0.118	0.5	51.3
103H6704-0140	103H6704-0110	0.52	1	6.5	16.5	0.14	0.55	55.8
103H6704-0440	103H6704-0410	0.52	2	1.7	3.8	0.14	0.55	55.8
103H6704-0740	103H6704-0710	0.53	3	0.9	1.7	0.14	0.55	55.8

Characteristics

103H6701-0140 103H6701-0110

Constant current circuit
Input voltage: 24 VDC
Winding current:
1 A/phase
At 2-phase excitation (full step)
Pull-out torque:
 $J_L = 0.94 \times 10^{-4} \text{kg}\cdot\text{m}^2$
(with rubber coupling used)
 f_s : Maximum starting pulse rate with no load

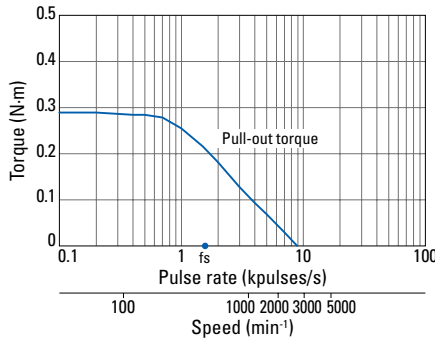

103H6701-0440 103H6701-0410

Constant current circuit
Input voltage: 24 VDC
Winding current:
2 A/phase
At 2-phase excitation (full step)
Pull-out torque:
 $J_L = 0.94 \times 10^{-4} \text{kg}\cdot\text{m}^2$
(with rubber coupling used)
 f_s : Maximum starting pulse rate with no load

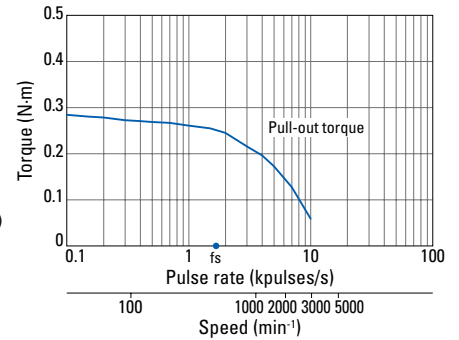

103H6701-0740 103H6701-0710

Constant current circuit
Input voltage: 24 VDC
Winding current:
3 A/phase
At 2-phase excitation (full step)
Pull-out torque:
 $J_L = 0.94 \times 10^{-4} \text{kg}\cdot\text{m}^2$
(with rubber coupling used)
 f_s : Maximum starting pulse rate with no load

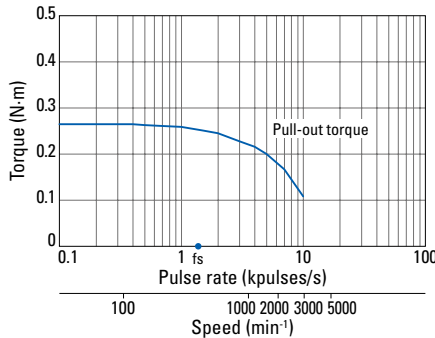

103H6703-0140 103H6703-0110

Constant current circuit
Input voltage: 24 VDC
Winding current:
1 A/phase
At 2-phase excitation (full step)
Pull-out torque:
 $J_L = 0.94 \times 10^{-4} \text{kg}\cdot\text{m}^2$
(with rubber coupling used)
 f_s : Maximum starting pulse rate with no load

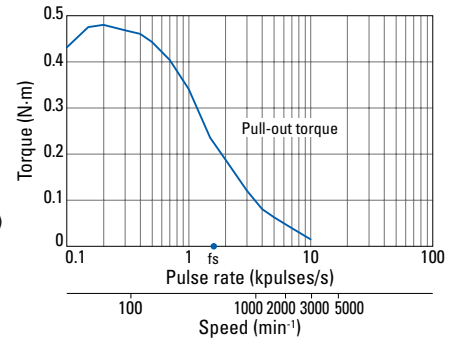

103H6703-0440 103H6703-0410

Constant current circuit
Input voltage: 24 VDC
Winding current:
2 A/phase
At 2-phase excitation (full step)
Pull-out torque:
 $J_L = 0.94 \times 10^{-4} \text{kg}\cdot\text{m}^2$
(with rubber coupling used)
 f_s : Maximum starting pulse rate with no load

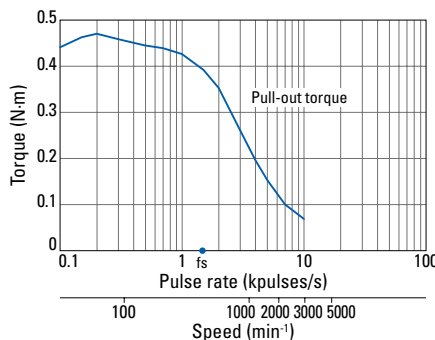

103H6703-0740 103H6703-0710

Constant current circuit
Input voltage: 24 VDC
Winding current:
3 A/phase
At 2-phase excitation (full step)
Pull-out torque:
 $J_L = 0.94 \times 10^{-4} \text{kg}\cdot\text{m}^2$
(with rubber coupling used)
 f_s : Maximum starting pulse rate with no load

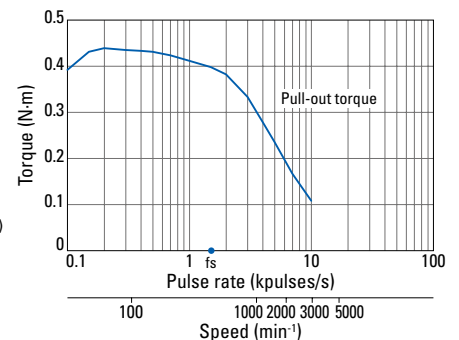

Characteristics

103H6704-0140 103H6704-0110

Constant current circuit
Input voltage: 24 VDC
Winding current:
1 A/phase
At 2-phase excitation (full step)
Pull-out torque:
 $J_L = 0.94 \times 10^{-4} \text{kg}\cdot\text{m}^2$
(with rubber coupling used)
 f_s : Maximum starting pulse rate with no load

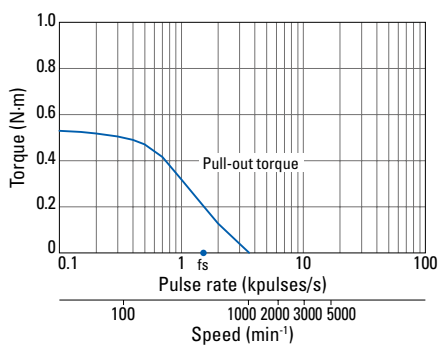

103H6704-0440 103H6704-0410

Constant current circuit
Input voltage: 24 VDC
Winding current:
2 A/phase
At 2-phase excitation (full step)
Pull-out torque:
 $J_L = 0.94 \times 10^{-4} \text{kg}\cdot\text{m}^2$
(with rubber coupling used)
 f_s : Maximum starting pulse rate with no load

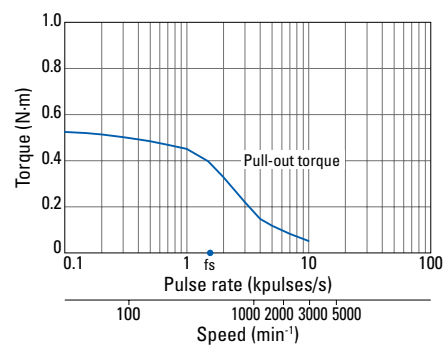

103H6704-0740 103H6704-0710

Constant current circuit
Input voltage: 24 VDC
Winding current:
3 A/phase
At 2-phase excitation (full step)
Pull-out torque:
 $J_L = 0.94 \times 10^{-4} \text{kg}\cdot\text{m}^2$
(with rubber coupling used)
 f_s : Maximum starting pulse rate with no load

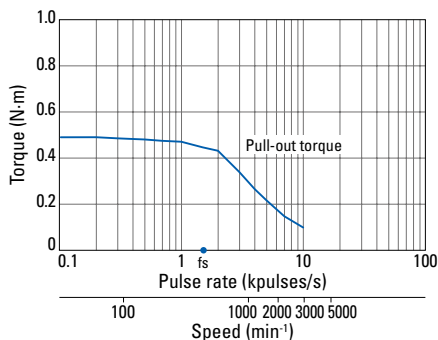

Dimensions (Unit: mm)

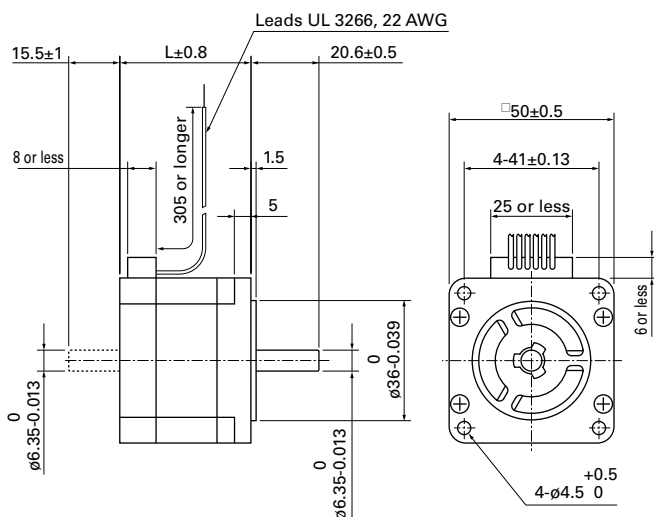

Internal winding

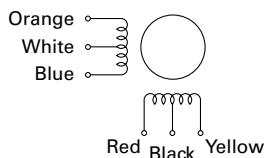

Compatible drivers

- For motors 103H670 □ -04 □ 0 (2 A/phase)...
Model no.: US1D200P10 (DC input)
Operating current selection switch setting: 0
- For motors other than above...
A driver is to be provided by the customer.

Note: The characteristics shown above are calculated using our experimental circuit.

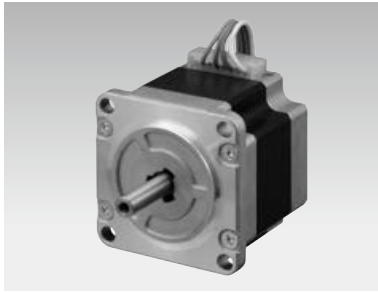

50 mm sq.

1.8°/step **RoHS**

Bipolar, lead type
Unipolar, lead type ▶ p. 46

Custom options

- Hollow shaft Custom shaft
- Encoder

Note: Customization feasibility depends on the model number and quantity. Contact us for details.

Bipolar, lead type

Model no.		Holding torque at 2-phase excitation	Rated current	Winding resistance	Winding inductance	Rotor inertia	Mass	Motor length (L)
Single shaft	Dual shaft	N·m or more	A/phase	Ω/phase	mH/phase	×10 ⁻⁴ kg·m ²	kg	mm
103H6701-5040	103H6701-5010	0.28	2	0.6	1.6	0.057	0.35	39.8
103H6703-5040	103H6703-5010	0.49	2	0.8	3.2	0.118	0.5	51.3
103H6704-5040	103H6704-5010	0.52	2	0.9	3.8	0.14	0.55	55.8

Characteristics

103H6701-5040 103H6701-5010

Constant current circuit
Input voltage: 24 VDC
Winding current:
2 A/phase
At 2-phase excitation (full step)
Pull-out torque:
 $J_L = 0.94 \times 10^{-4} \text{kg}\cdot\text{m}^2$
(with rubber coupling used)
 f_s : Maximum starting pulse rate with no load

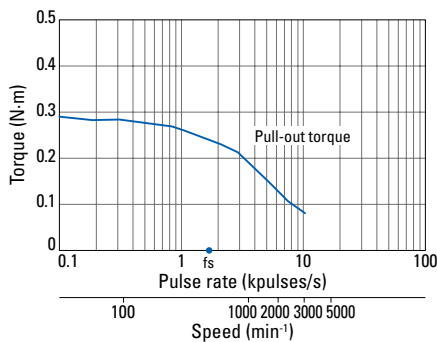

103H6703-5040 103H6703-5010

Constant current circuit
Input voltage: 24 VDC
Winding current:
2 A/phase
At 2-phase excitation (full step)
Pull-out torque:
 $J_L = 0.94 \times 10^{-4} \text{kg}\cdot\text{m}^2$
(with rubber coupling used)
 f_s : Maximum starting pulse rate with no load

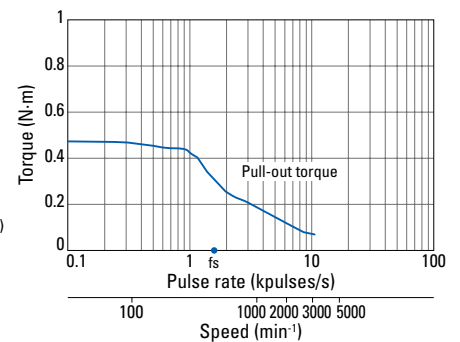

103H6704-5040 103H6704-5010

Constant current circuit
Input voltage: 24 VDC
Winding current:
2 A/phase
At 2-phase excitation (full step)
Pull-out torque:
 $J_L = 0.94 \times 10^{-4} \text{kg}\cdot\text{m}^2$
(with rubber coupling used)
 f_s : Maximum starting pulse rate with no load

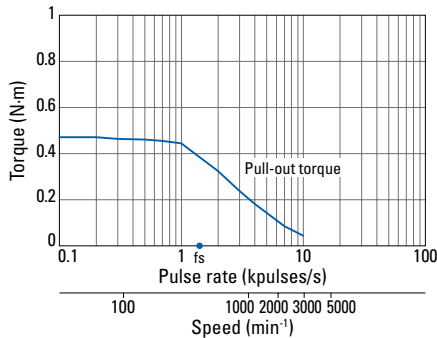

Dimensions (Unit: mm)

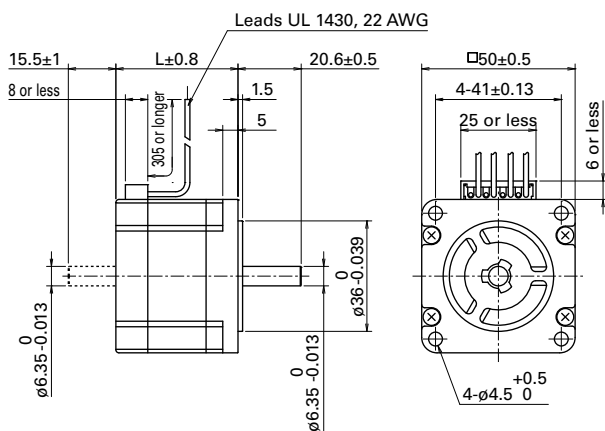

Internal winding

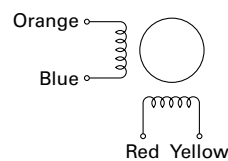

Compatible drivers

Model no.: BS1D200P10 (DC input)

Operating current selection switch setting: 0

Note: The characteristics shown above are calculated using our experimental circuit.



50 mm sq.

1.8°/step **Thin-profile** **RoHS**

Bipolar, lead type

Custom options

Hollow shaft **Custom shaft**

Note: Customization feasibility depends on the model number and quantity. Contact us for details.

Bipolar, lead type

Model no.		Holding torque at 2-phase excitation	Rated current	Winding resistance	Winding inductance	Rotor inertia	Mass	Motor length (L)
Single shaft	Dual shaft	N·m or more	A/phase	Ω/phase	mH/phase	$\times 10^{-4}$ kg·m ²	kg	mm
SS2501-8040	SS2501-8010	0.1	1	4.5	2	0.026	0.09	11.4
SS2502-8040	SS2502-8010	0.215	1	5.9	3.2	0.049	0.15	16.4

Characteristics

SS2501-8040 SS2501-8010

Constant current circuit
Input voltage: 24 VDC
Winding current:
1 A/phase
At 2-phase excitation (full step)
Pull-out torque:
 $J_L = 0.01 \times 10^{-4}$ kg·m²
(Pulley balancer method)
fs: Maximum starting pulse rate with no load

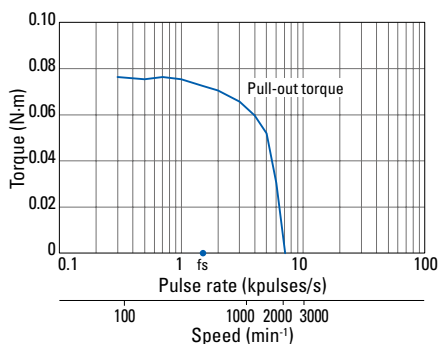

SS2502-8040 SS2502-8010

Constant current circuit
Input voltage: 24 VDC
Winding current:
1 A/phase
At 2-phase excitation (full step)
Pull-out torque:
 $J_L = 0.01 \times 10^{-4}$ kg·m²
(Pulley balancer method)
fs: Maximum starting pulse rate with no load

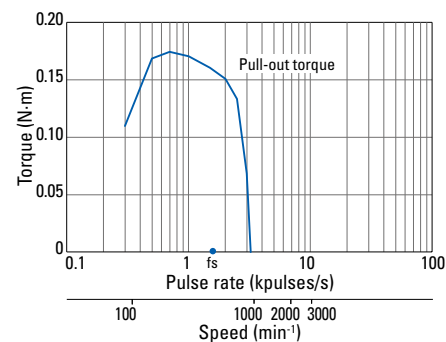

Dimensions (Unit: mm)

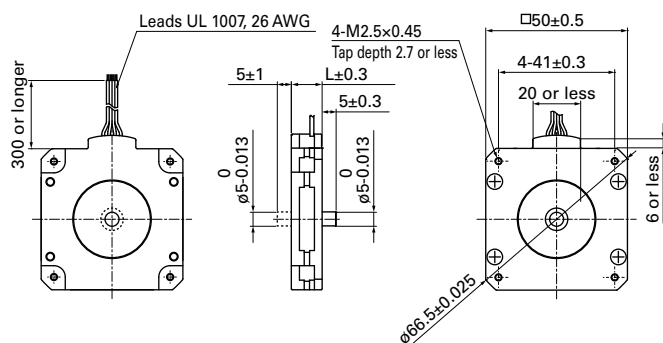

Internal winding

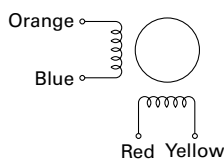

Compatible drivers

Model no.: BS1D200P10 (DC input)

Operating current selection switch setting: A

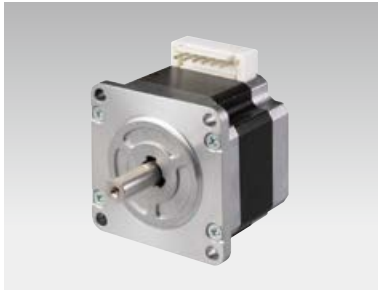

56 mm sq.

1.8°/step **RoHS**

Unipolar, connector type



Custom options

Hollow shaft Custom shaft

Gear Encoder

Brake

Note: Customization feasibility depends on the model number and quantity. Contact us for details.

Unipolar, connector type

Model no.		Holding torque at 2-phase excitation	Rated current	Winding resistance	Winding inductance	Rotor inertia	Mass	Motor length (L)
Single shaft	Dual shaft	N·m or more	A/phase	Ω/phase	mH/phase	×10 ⁻⁴ kg·m ²	kg	mm
SM2561C10U41	SM2561C10U11	0.53	1	4.3	6.8	0.14	0.49	41.8
SM2561C20U41	SM2561C20U11	0.53	2	1.15	1.8	0.14	0.49	41.8
SM2561C30U41	SM2561C30U11	0.53	3	0.52	0.77	0.14	0.49	41.8
SM2562C10U41	SM2562C10U11	1.1	1	5.85	12.6	0.28	0.69	53.8
SM2562C20U41	SM2562C20U11	1.1	2	1.55	3.3	0.28	0.69	53.8
SM2562C30U41	SM2562C30U11	1.1	3	0.69	1.37	0.28	0.69	53.8
SM2563C10U41	SM2563C10U11	1.7	1	7.8	17	0.5	1.1	75.8
SM2563C20U41	SM2563C20U11	1.7	2	1.87	4.2	0.5	1.1	75.8
SM2563C30U41	SM2563C30U11	1.7	3	0.74	1.75	0.5	1.1	75.8
SM2564C10U41	SM2564C10U11	1.75	1	9	22	0.6	1.27	85.8
SM2564C20U41	SM2564C20U11	1.75	2	2.1	5.4	0.6	1.27	85.8
SM2564C30U41	SM2564C30U11	1.75	3	0.84	2.2	0.6	1.27	85.8

Motor cable model no.: 4837798-1

Characteristics

SM2561C10U41 SM2561C10U11

Constant current circuit
Input voltage: 24 VDC
Winding current:
1 A/phase
At 2-phase excitation (full step)
Pull-out torque:
 $J_L = 0.94 \times 10^{-4} \text{kg}\cdot\text{m}^2$
(with rubber coupling used)
 f_s : Maximum starting pulse rate with no load

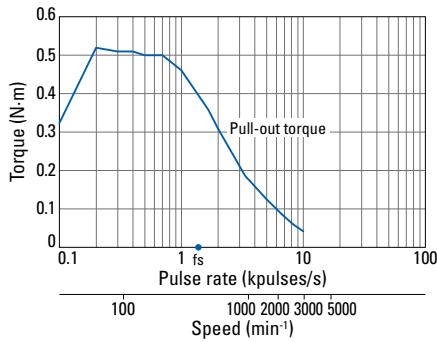

SM2561C20U41 SM2561C20U11

Constant current circuit
Input voltage: 24 VDC
Winding current:
2 A/phase
At 2-phase excitation (full step)
Pull-out torque:
 $J_L = 0.94 \times 10^{-4} \text{kg}\cdot\text{m}^2$
(with rubber coupling used)
 f_s : Maximum starting pulse rate with no load

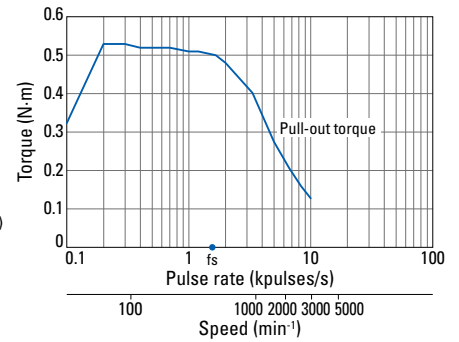

SM2561C30U41 SM2561C30U11

Constant current circuit
Input voltage: 24 VDC
Winding current:
3 A/phase
At 2-phase excitation (full step)
Pull-out torque:
 $J_L = 0.94 \times 10^{-4} \text{kg}\cdot\text{m}^2$
(with rubber coupling used)
 f_s : Maximum starting pulse rate with no load

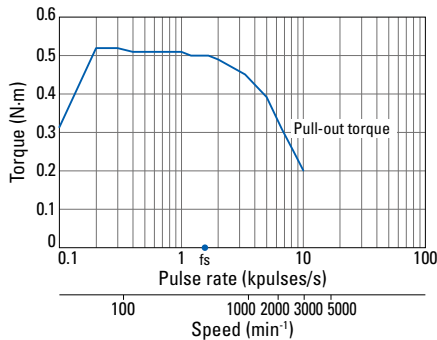

SM2562C10U41 SM2562C10U11

Constant current circuit
Input voltage: 24 VDC
Winding current:
1 A/phase
At 2-phase excitation (full step)
Pull-out torque:
 $J_L = 2.6 \times 10^{-4} \text{kg}\cdot\text{m}^2$
(with rubber coupling used)
 f_s : Maximum starting pulse rate with no load

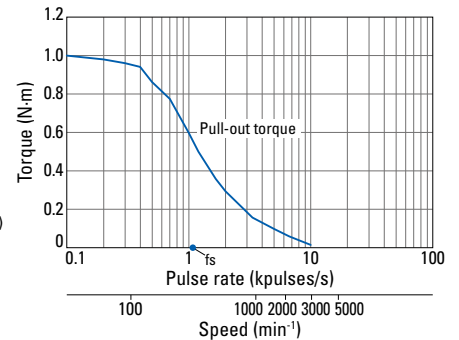

SM2562C20U41 SM2562C20U11

Constant current circuit
Input voltage: 24 VDC
Winding current:
2 A/phase
At 2-phase excitation (full step)
Pull-out torque:
 $J_L = 2.6 \times 10^{-4} \text{kg}\cdot\text{m}^2$
(with rubber coupling used)
 f_s : Maximum starting pulse rate with no load

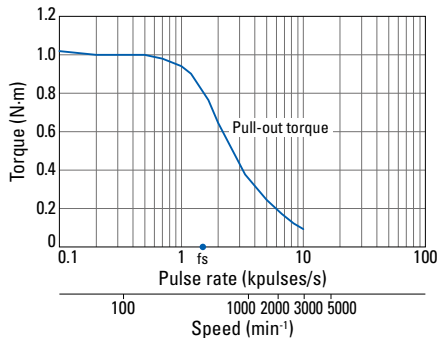

SM2562C30U41 SM2562C30U11

Constant current circuit
Input voltage: 24 VDC
Winding current:
3 A/phase
At 2-phase excitation (full step)
Pull-out torque:
 $J_L = 2.6 \times 10^{-4} \text{kg}\cdot\text{m}^2$
(with rubber coupling used)
 f_s : Maximum starting pulse rate with no load

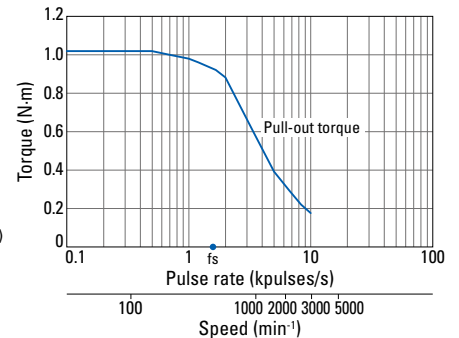

Characteristics

SM2563C10U41 SM2563C10U11

Constant current circuit
Input voltage: 24 VDC
Winding current:
1 A/phase
At 2-phase excitation (full step)
Pull-out torque:
 $J_L = 7.4 \times 10^{-4} \text{kg}\cdot\text{m}^2$
(with rubber coupling used)
fs: Maximum starting pulse rate with no load

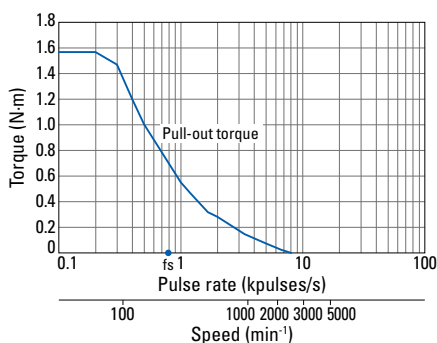

SM2563C20U41 SM2563C20U11

Constant current circuit
Input voltage: 24 VDC
Winding current:
2 A/phase
At 2-phase excitation (full step)
Pull-out torque:
 $J_L = 7.4 \times 10^{-4} \text{kg}\cdot\text{m}^2$
(with rubber coupling used)
fs: Maximum starting pulse rate with no load

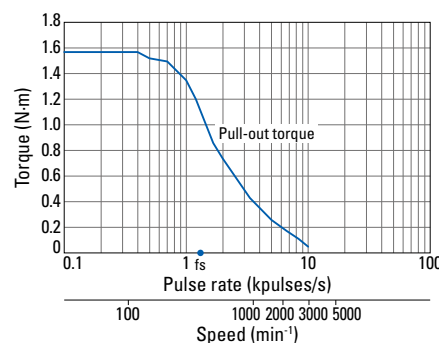

SM2563C30U41 SM2563C30U11

Constant current circuit
Input voltage: 24 VDC
Winding current:
3 A/phase
At 2-phase excitation (full step)
Pull-out torque:
 $J_L = 7.4 \times 10^{-4} \text{kg}\cdot\text{m}^2$
(with rubber coupling used)
fs: Maximum starting pulse rate with no load

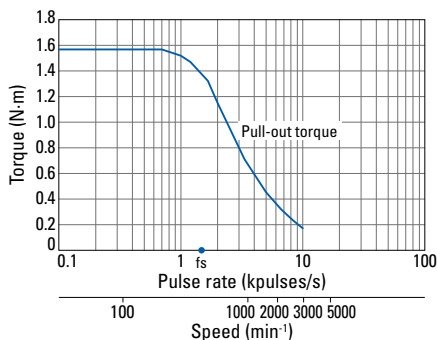

SM2564C10U41 SM2564C10U11

Constant current circuit
Input voltage: 24 VDC
Winding current:
1 A/phase
At 2-phase excitation (full step)
Pull-out torque:
 $J_L = 7.4 \times 10^{-4} \text{kg}\cdot\text{m}^2$
(with rubber coupling used)
fs: Maximum starting pulse rate with no load

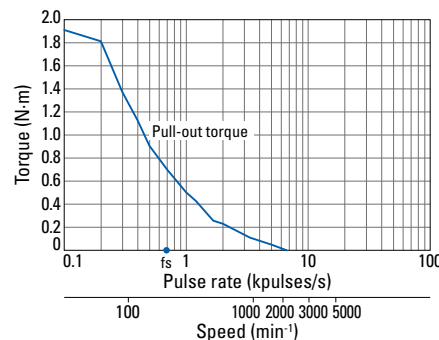

SM2564C20U41 SM2564C20U11

Constant current circuit
Input voltage: 24 VDC
Winding current:
2 A/phase
At 2-phase excitation (full step)
Pull-out torque:
 $J_L = 7.4 \times 10^{-4} \text{kg}\cdot\text{m}^2$
(with rubber coupling used)
fs: Maximum starting pulse rate with no load

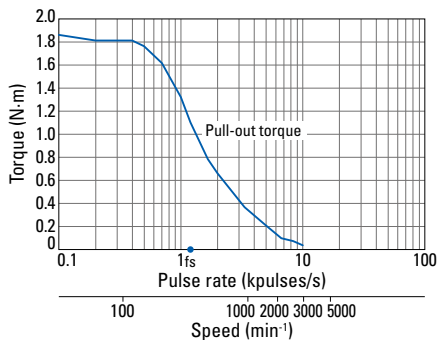

SM2564C30U41 SM2564C30U11

Constant current circuit
Input voltage: 24 VDC
Winding current:
3 A/phase
At 2-phase excitation (full step)
Pull-out torque:
 $J_L = 7.4 \times 10^{-4} \text{kg}\cdot\text{m}^2$
(with rubber coupling used)
fs: Maximum starting pulse rate with no load

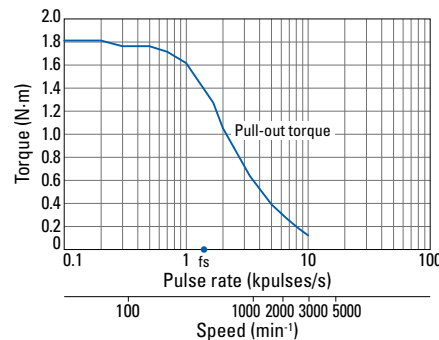

Dimensions (Unit: mm)

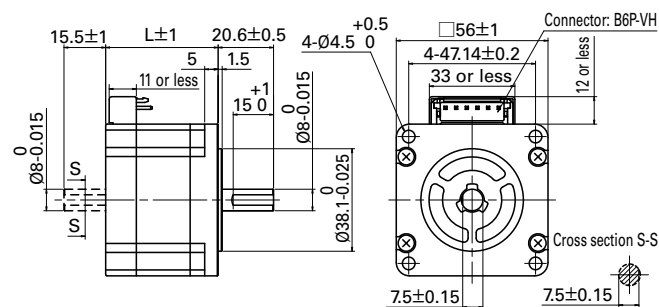

Separate option: Motor cable 4837798-1

Mfr.: J.S.T.

Housing: VHR-6N

Terminal: SVH-21T-P1.1

Terminal no.	Lead color
6	Black
5	Yellow
4	Red
3	Blue
2	Orange
1	White

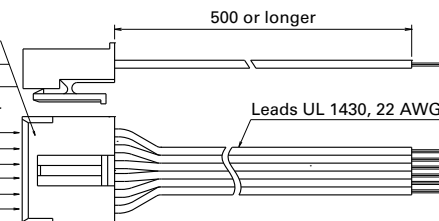

Internal wiring

In parentheses are connector pin nos.

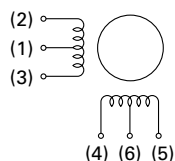

Compatible drivers

- For motors SM256□C20U□1 (2 A/phase)...

Model no.: US1D200P10 (DC input)

Operating current selection switch setting: 0

- For motors other than above...

A driver is to be provided by the customer.

Note: The characteristics shown above are calculated using our experimental circuit.

If considering replacing our conventional 56 mm sq. motors (103H712□),

→ See Models No Longer Listed and Their Replacement Models in p. 78 to 79



56 mm sq.

1.8°/step **RoHS**
Bipolar, connector type



Custom options

- Hollow shaft Custom shaft
- Gear Encoder
- Brake

Note: Customization feasibility depends on the model number and quantity. Contact us for details.

Bipolar, connector type

Model no.		Holding torque at 2-phase excitation	Rated current	Winding resistance	Winding inductance	Rotor inertia	Mass	Motor length (L)
Single shaft	Dual shaft	N·m or more	A/phase	Ω/phase	mH/phase	×10 ⁻⁴ kg·m ²	kg	mm
SM2561C10B41	SM2561C10B11	0.75	1	4.6	13.5	0.14	0.49	41.8
SM2561C20B41	SM2561C20B11	0.75	2	1.1	3.5	0.14	0.49	41.8
SM2561C30B41	SM2561C30B11	0.75	3	0.51	1.5	0.14	0.49	41.8
SM2561C40B41	SM2561C40B11	0.75	4	0.28	0.85	0.14	0.49	41.8
SM2561C60B41	SM2561C60B11	0.75	6	0.14	0.38	0.14	0.49	41.8
SM2562C10B41	SM2562C10B11	1.4	1	6.3	25.5	0.28	0.69	53.8
SM2562C20B41	SM2562C20B11	1.4	2	1.5	6.5	0.28	0.69	53.8
SM2562C30B41	SM2562C30B11	1.4	3	0.68	2.9	0.28	0.69	53.8
SM2562C40B41	SM2562C40B11	1.4	4	0.37	1.5	0.28	0.69	53.8
SM2562C60B41	SM2562C60B11	1.4	6	0.18	0.72	0.28	0.69	53.8
SM2563C10B41	SM2563C10B11	2.35	1	8.6	36	0.5	1.1	75.8
SM2563C20B41	SM2563C20B11	2.35	2	2.1	9.5	0.5	1.1	75.8
SM2563C30B41	SM2563C30B11	2.35	3	0.95	4.2	0.5	1.1	75.8
SM2563C40B41	SM2563C40B11	2.35	4	0.52	2.4	0.5	1.1	75.8
SM2563C60B41	SM2563C60B11	2.35	6	0.25	1.05	0.5	1.1	75.8
SM2564C10B41	SM2564C10B11	2.5	1	9.4	41	0.6	1.27	85.8
SM2564C20B41	SM2564C20B11	2.5	2	2.1	11	0.6	1.27	85.8
SM2564C30B41	SM2564C30B11	2.5	3	0.95	4.9	0.6	1.27	85.8
SM2564C40B41	SM2564C40B11	2.5	4	0.59	2.8	0.6	1.27	85.8
SM2564C60B41	SM2564C60B11	2.5	6	0.27	1.15	0.6	1.27	85.8

Motor cable model no.: 4837961-1

Characteristics

SM2561C10B41 SM2561C10B11

Constant current circuit
Input voltage: 24 VDC
Winding current:
1 A/phase
At 2-phase excitation (full step)
Pull-out torque:
 $J_L = 0.94 \times 10^{-4} \text{kg}\cdot\text{m}^2$
(with rubber coupling used)
 f_s : Maximum starting pulse rate with no load

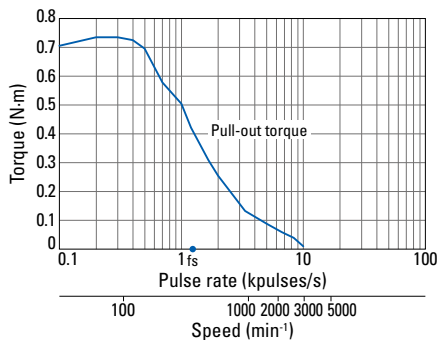

SM2561C20B41 SM2561C20B11

Constant current circuit
Input voltage: 24 VDC
Winding current:
2 A/phase
At 2-phase excitation (full step)
Pull-out torque:
 $J_L = 0.94 \times 10^{-4} \text{kg}\cdot\text{m}^2$
(with rubber coupling used)
 f_s : Maximum starting pulse rate with no load

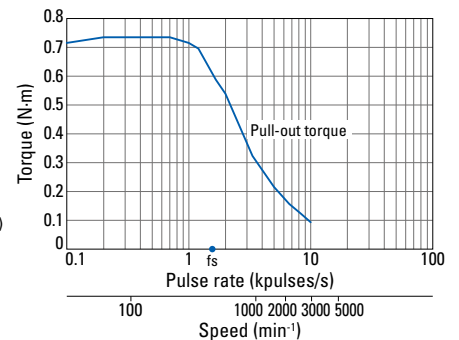

SM2561C30B41 SM2561C30B11

Constant current circuit
Input voltage: 24 VDC
Winding current:
3 A/phase
At 2-phase excitation (full step)
Pull-out torque:
 $J_L = 0.94 \times 10^{-4} \text{kg}\cdot\text{m}^2$
(with rubber coupling used)
 f_s : Maximum starting pulse rate with no load

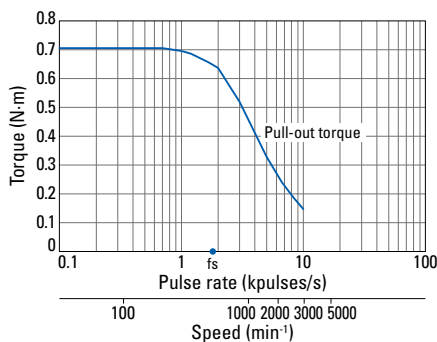

SM2561C40B41 SM2561C40B11

Constant current circuit
Input voltage: 24 VDC
Winding current:
4 A/phase
At 2-phase excitation (full step)
Pull-out torque:
 $J_L = 0.94 \times 10^{-4} \text{kg}\cdot\text{m}^2$
(with rubber coupling used)
 f_s : Maximum starting pulse rate with no load

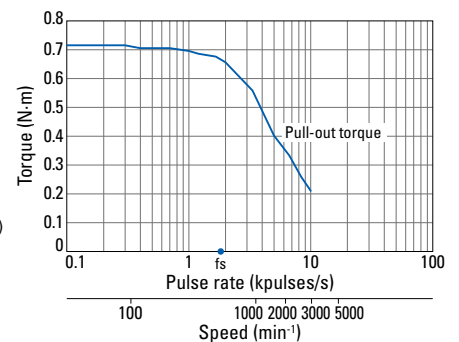

Characteristics

SM2561C60B41 SM2561C60B11

Constant current circuit
Input voltage: 24 VDC
Winding current:
6 A/phase
At 2-phase excitation (full
step)
Pull-out torque:
 $J_L = 0.94 \times 10^{-4} \text{kg}\cdot\text{m}^2$
(with rubber coupling used)
 f_s : Maximum starting pulse
rate with no load

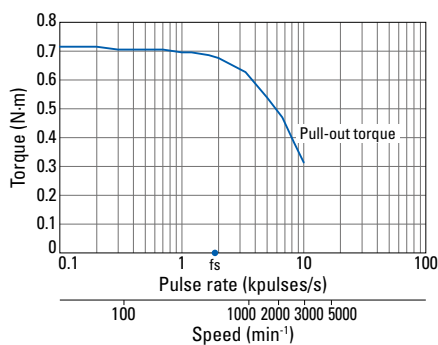

SM2562C20B41 SM2562C20B11

Constant current circuit
Input voltage: 24 VDC
Winding current:
2 A/phase
At 2-phase excitation (full
step)
Pull-out torque:
 $J_L = 2.6 \times 10^{-4} \text{kg}\cdot\text{m}^2$
(with rubber coupling used)
 f_s : Maximum starting pulse
rate with no load

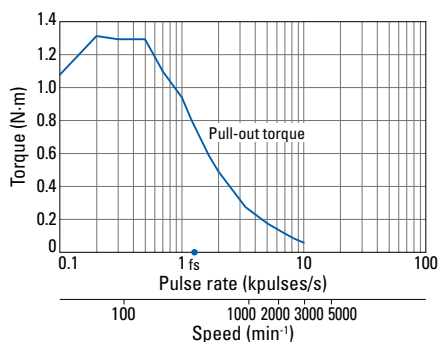

SM2562C40B41 SM2562C40B11

Constant current circuit
Input voltage: 24 VDC
Winding current:
4 A/phase
At 2-phase excitation (full
step)
Pull-out torque:
 $J_L = 2.6 \times 10^{-4} \text{kg}\cdot\text{m}^2$
(with rubber coupling used)
 f_s : Maximum starting pulse
rate with no load

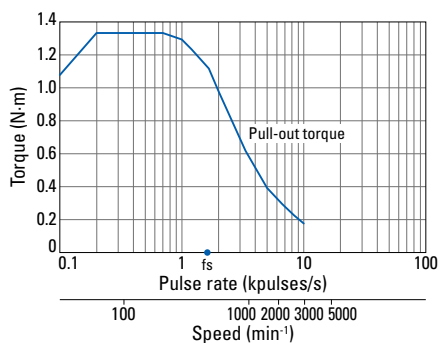

SM2563C10B41 SM2563C10B11

Constant current circuit
Input voltage: 24 VDC
Winding current:
1 A/phase
At 2-phase excitation (full
step)
Pull-out torque:
 $J_L = 7.4 \times 10^{-4} \text{kg}\cdot\text{m}^2$
(with rubber coupling used)
 f_s : Maximum starting pulse
rate with no load

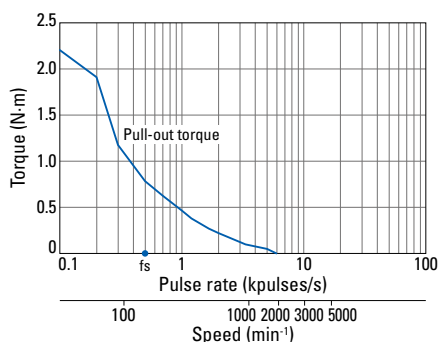

SM2563C30B41 SM2563C30B11

Constant current circuit
Input voltage: 24 VDC
Winding current:
3 A/phase
At 2-phase excitation (full
step)
Pull-out torque:
 $J_L = 7.4 \times 10^{-4} \text{kg}\cdot\text{m}^2$
(with rubber coupling used)
 f_s : Maximum starting pulse
rate with no load

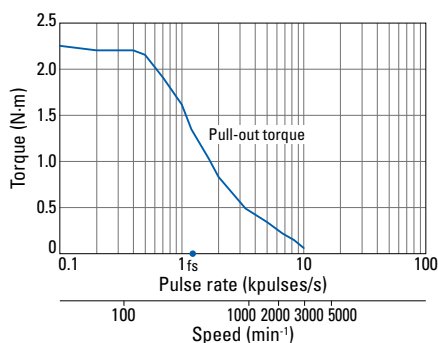

SM2562C10B41 SM2562C10B11

Constant current circuit
Input voltage: 24 VDC
Winding current:
1 A/phase
At 2-phase excitation (full
step)
Pull-out torque:
 $J_L = 2.6 \times 10^{-4} \text{kg}\cdot\text{m}^2$
(with rubber coupling used)
 f_s : Maximum starting pulse
rate with no load

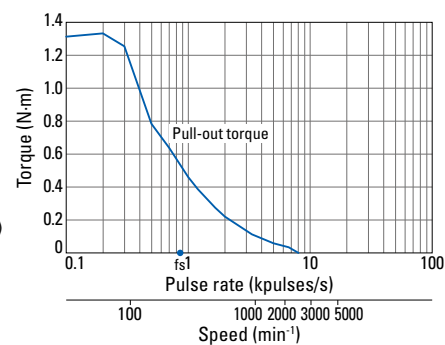

SM2562C30B41 SM2562C30B11

Constant current circuit
Input voltage: 24 VDC
Winding current:
3 A/phase
At 2-phase excitation (full
step)
Pull-out torque:
 $J_L = 2.6 \times 10^{-4} \text{kg}\cdot\text{m}^2$
(with rubber coupling used)
 f_s : Maximum starting pulse
rate with no load

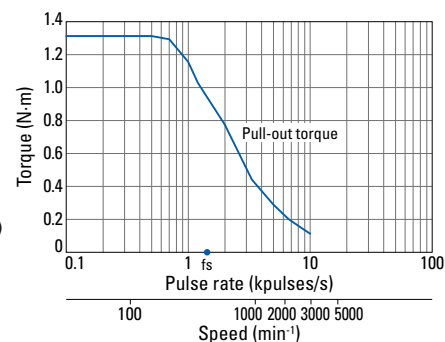

SM2562C60B41 SM2562C60B11

Constant current circuit
Input voltage: 24 VDC
Winding current:
6 A/phase
At 2-phase excitation (full
step)
Pull-out torque:
 $J_L = 2.6 \times 10^{-4} \text{kg}\cdot\text{m}^2$
(with rubber coupling used)
 f_s : Maximum starting pulse
rate with no load

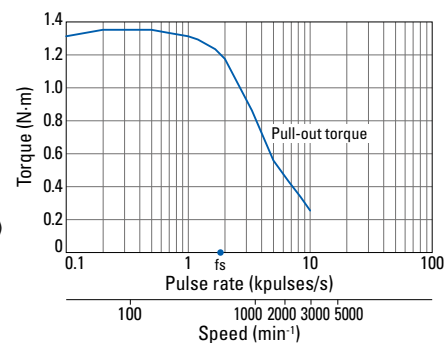

SM2563C20B41 SM2563C20B11

Constant current circuit
Input voltage: 24 VDC
Winding current:
2 A/phase
At 2-phase excitation (full
step)
Pull-out torque:
 $J_L = 7.4 \times 10^{-4} \text{kg}\cdot\text{m}^2$
(with rubber coupling used)
 f_s : Maximum starting pulse
rate with no load

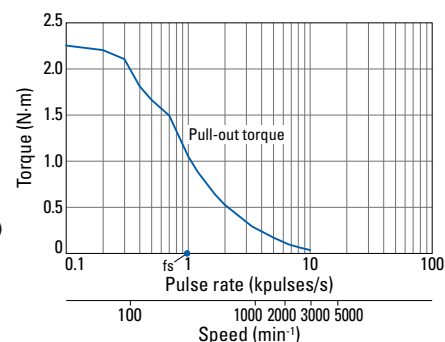

SM2563C40B41 SM2563C40B11

Constant current circuit
Input voltage: 24 VDC
Winding current:
4 A/phase
At 2-phase excitation (full
step)
Pull-out torque:
 $J_L = 7.4 \times 10^{-4} \text{kg}\cdot\text{m}^2$
(with rubber coupling used)
 f_s : Maximum starting pulse
rate with no load

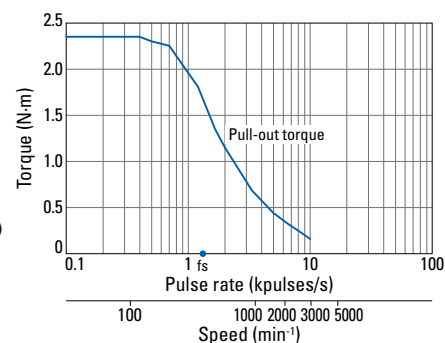

Characteristics

SM2563C60B41 SM2563C60B11

Constant current circuit
Input voltage: 24 VDC
Winding current:
6 A/phase
At 2-phase excitation (full step)
Pull-out torque:
 $J_L = 7.4 \times 10^{-4} \text{kg}\cdot\text{m}^2$
(with rubber coupling used)
 f_s : Maximum starting pulse rate with no load

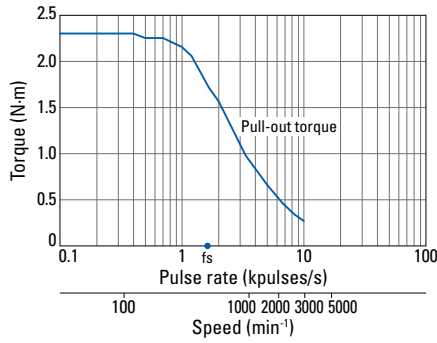

SM2564C10B41 SM2564C10B11

Constant current circuit
Input voltage: 24 VDC
Winding current:
1 A/phase
At 2-phase excitation (full step)
Pull-out torque:
 $J_L = 7.4 \times 10^{-4} \text{kg}\cdot\text{m}^2$
(with rubber coupling used)
 f_s : Maximum starting pulse rate with no load

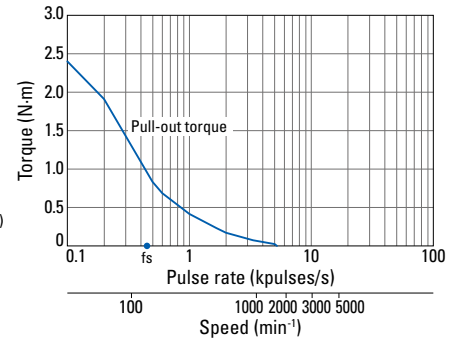

SM2564C20B41 SM2564C20B11

Constant current circuit
Input voltage: 24 VDC
Winding current:
2 A/phase
At 2-phase excitation (full step)
Pull-out torque:
 $J_L = 7.4 \times 10^{-4} \text{kg}\cdot\text{m}^2$
(with rubber coupling used)
 f_s : Maximum starting pulse rate with no load

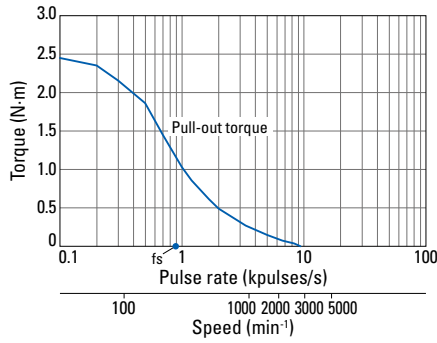

SM2564C30B41 SM2564C30B11

Constant current circuit
Input voltage: 24 VDC
Winding current:
3 A/phase
At 2-phase excitation (full step)
Pull-out torque:
 $J_L = 7.4 \times 10^{-4} \text{kg}\cdot\text{m}^2$
(with rubber coupling used)
 f_s : Maximum starting pulse rate with no load

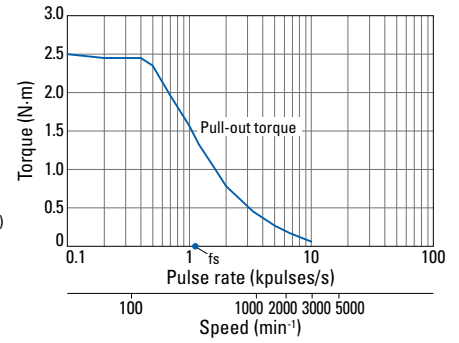

SM2564C40B41 SM2564C40B11

Constant current circuit
Input voltage: 24 VDC
Winding current:
4 A/phase
At 2-phase excitation (full step)
Pull-out torque:
 $J_L = 7.4 \times 10^{-4} \text{kg}\cdot\text{m}^2$
(with rubber coupling used)
 f_s : Maximum starting pulse rate with no load

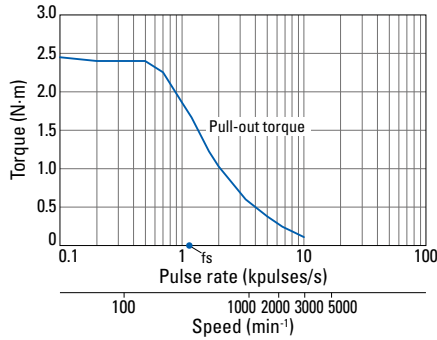

SM2564C60B41 SM2564C60B11

Constant current circuit
Input voltage: 24 VDC
Winding current:
6 A/phase
At 2-phase excitation (full step)
Pull-out torque:
 $J_L = 7.4 \times 10^{-4} \text{kg}\cdot\text{m}^2$
(with rubber coupling used)
 f_s : Maximum starting pulse rate with no load

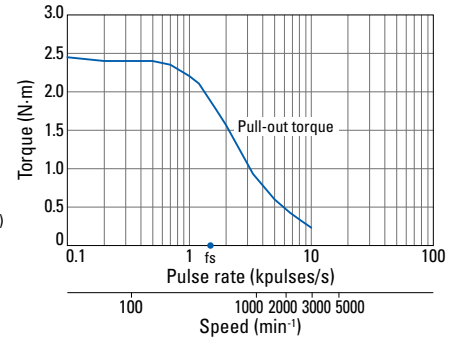

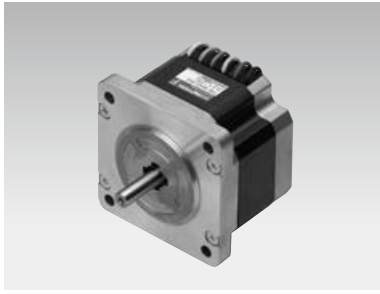

60 mm sq.

0.9°/step **RoHS**

Unipolar, lead type
Bipolar, lead type



Custom options

- Hollow shaft Custom shaft
- Gear Encoder

Note: Customization feasibility depends on the model number and quantity. Contact us for details.

Unipolar, lead type

Model no.		Holding torque at 2-phase excitation	Rated current	Winding resistance	Winding inductance	Rotor inertia	Mass	Motor length (L)	Shaft diameter (D)
Single shaft	Dual shaft	N·m or more	A/phase	Ω/phase	mH/phase	×10 ⁻⁴ kg·m ²	kg	mm	mm
SH1601-0440	SH1601-0410	0.57	2	1.35	2	0.24	0.55	42	0 ø6.35-0.013
SH1602-0440	SH1602-0410	1.1	2	1.8	3.5	0.4	0.8	54	0 ø6.35-0.013
SH1603-0440	SH1603-0410	1.7	2	2.3	4.5	0.75	1.2	76	0 ø8-0.015

Characteristics

SH1601-0440 SH1601-0410

Constant current circuit
Input voltage: 24 VDC
Winding current:
2 A/phase
At 2-phase excitation (full step)
Pull-out torque:
 $J_L = 0.94 \times 10^{-4} \text{kg}\cdot\text{m}^2$
(with rubber coupling used)
fs: Maximum starting pulse rate with no load

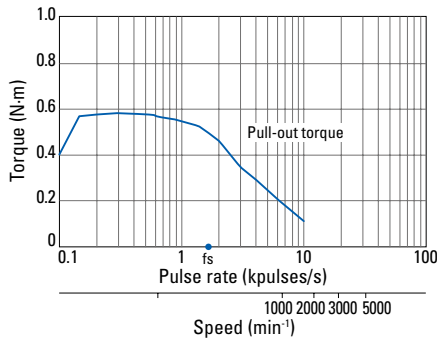

SH1602-0440 SH1602-0410

Constant current circuit
Input voltage: 24 VDC
Winding current:
2 A/phase
At 2-phase excitation (full step)
Pull-out torque:
 $J_L = 2.6 \times 10^{-4} \text{kg}\cdot\text{m}^2$
(with rubber coupling used)
fs: Maximum starting pulse rate with no load

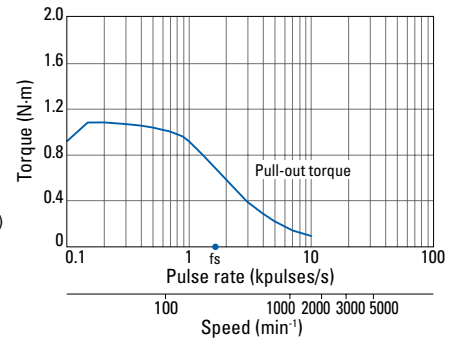

SH1603-0440 SH1603-0410

Constant current circuit
Input voltage: 24 VDC
Winding current:
2 A/phase
At 2-phase excitation (full step)
Pull-out torque:
 $J_L = 7.4 \times 10^{-4} \text{kg}\cdot\text{m}^2$
(with rubber coupling used)
fs: Maximum starting pulse rate with no load

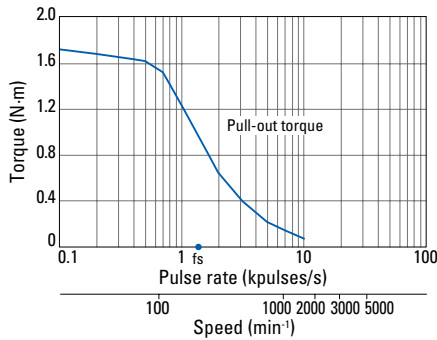

Dimensions (Unit: mm)

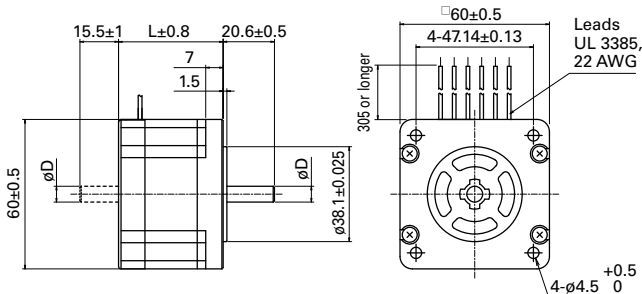

Internal winding

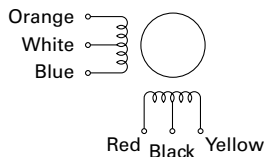

Compatible drivers

A driver is to be provided by the customer.

Bipolar, lead type

Model no.		Holding torque at 2-phase excitation	Rated current	Winding resistance	Winding inductance	Rotor inertia	Mass	Motor length (L)	Shaft diameter (D)
Single shaft	Dual shaft	N·m or more	A/phase	Ω/phase	mH/phase	×10 ⁻⁴ kg·m ²	kg	mm	mm
SH1601-5240	SH1601-5210	0.69	2	1.2	3.5	0.24	0.55	42	0 ø6.35-0.013
SH1602-5240	SH1602-5210	1.28	2	1.65	6.1	0.4	0.8	54	0 ø6.35-0.013
SH1603-5240	SH1603-5210	2.15	2	2.3	8.8	0.75	1.2	76	0 ø8-0.015

Characteristics

**SH1601-5240
SH1601-5210**

Constant current circuit
Input voltage: 24 VDC
Winding current: 2 A/phase
At 2-phase excitation (full step)
Pull-out torque:
 $J_L = 0.94 \times 10^{-4} \text{kg}\cdot\text{m}^2$
(with rubber coupling used)
 f_s : Maximum starting pulse rate with no load

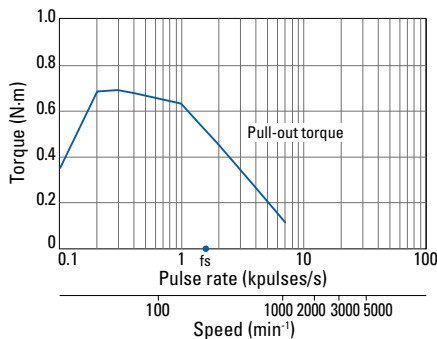

**SH1602-5240
SH1602-5210**

Constant current circuit
Input voltage: 24 VDC
Winding current: 2 A/phase
At 2-phase excitation (full step)
Pull-out torque:
 $J_L = 2.6 \times 10^{-4} \text{kg}\cdot\text{m}^2$
(with rubber coupling used)
 f_s : Maximum starting pulse rate with no load

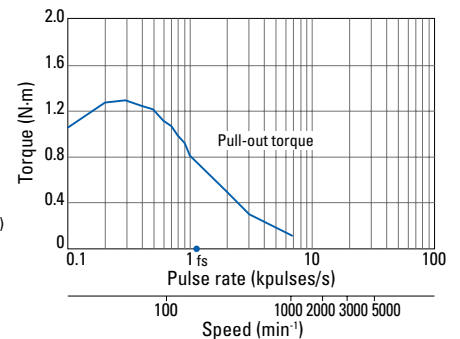

**SH1603-5240
SH1603-5210**

Constant current circuit
Input voltage: 24 VDC
Winding current: 2 A/phase
At 2-phase excitation (full step)
Pull-out torque:
 $J_L = 7.4 \times 10^{-4} \text{kg}\cdot\text{m}^2$
(with rubber coupling used)
 f_s : Maximum starting pulse rate with no load

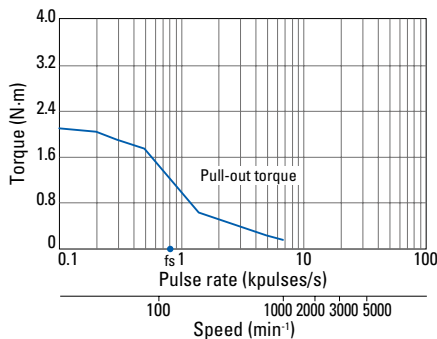

Dimensions (Unit: mm)

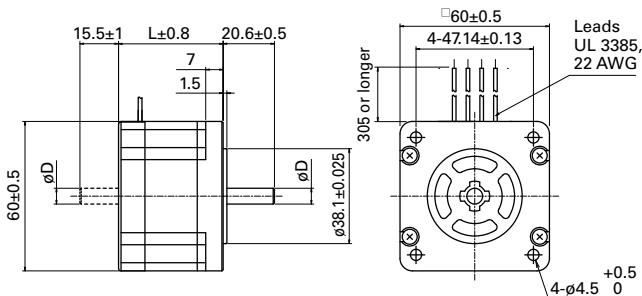

Internal winding

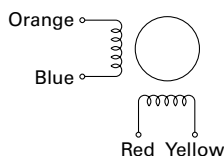

Compatible drivers

Model no.: BS1D200P10 (DC input)
Operating current selection switch setting: 0
Note: The characteristics shown above are calculated using our experimental circuit.

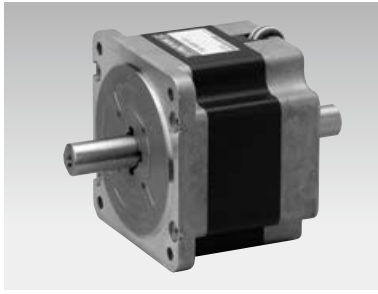

86 mm sq.

1.8°/step **RoHS**

Unipolar, lead type
Bipolar, lead type ▶ p. 60



Custom options

- Hollow shaft Custom shaft
- Encoder Brake

Note: Customization feasibility depends on the model number and quantity. Contact us for details.

Unipolar, lead type

Model no.		Holding torque at 2-phase excitation	Rated current	Winding resistance	Winding inductance	Rotor inertia	Mass	Motor length (L)
Single shaft	Dual shaft	N·m or more	A/phase	Ω/phase	mH/phase	×10 ⁻⁴ kg·m ²	kg	mm
SH2861-0441	SH2861-0411	2.5	2	2.3	8.0	1.48	1.75	66
SH2861-0941	SH2861-0911	2.5	4	0.6	2.0	1.48	1.75	66
SH2862-0441	SH2862-0411	4.7	2	3.2	13.0	3.0	2.9	96.5
SH2862-0941	SH2862-0911	4.7	4	0.85	3.4	3.0	2.9	96.5
SH2863-0441	SH2863-0411	6.7	2	4.0	17.0	4.5	4.0	127
SH2863-0941	SH2863-0911	6.7	4	0.9	4.2	4.5	4.0	127

Characteristics

SH2861-0441 SH2861-0411

Constant current circuit
Input voltage: 100 VAC
Winding current:
2 A/phase
At 2-phase excitation (full step)
Pull-out torque:
 $J_L = 7.4 \times 10^{-4} \text{kg}\cdot\text{m}^2$
(with rubber coupling used)
 f_s : Maximum starting pulse rate with no load

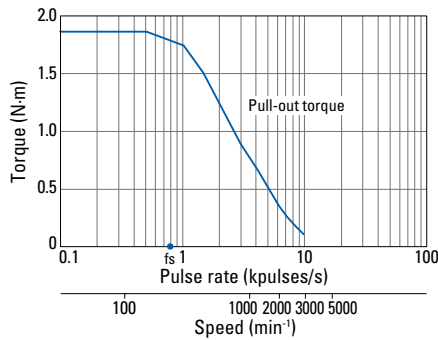

SH2861-0941 SH2861-0911

Constant current circuit
Input voltage: 100 VAC
Winding current:
4 A/phase
At 2-phase excitation (full step)
Pull-out torque:
 $J_L = 7.4 \times 10^{-4} \text{kg}\cdot\text{m}^2$
(with rubber coupling used)
 f_s : Maximum starting pulse rate with no load

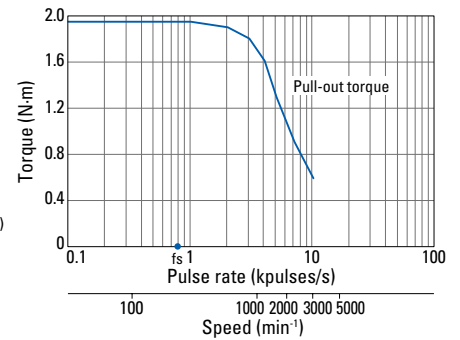

SH2862-0441 SH2862-0411

Constant current circuit
Input voltage: 100 VAC
Winding current:
2 A/phase
At 2-phase excitation (full step)
Pull-out torque:
 $J_L = 15.3 \times 10^{-4} \text{kg}\cdot\text{m}^2$
(with rubber coupling used)
 f_s : Maximum starting pulse rate with no load

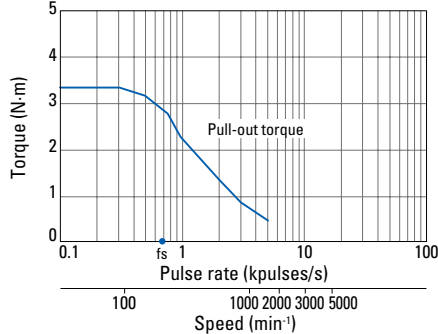

SH2862-0941 SH2862-0911

Constant current circuit
Input voltage: 100 VAC
Winding current:
4 A/phase
At 2-phase excitation (full step)
Pull-out torque:
 $J_L = 15.3 \times 10^{-4} \text{kg}\cdot\text{m}^2$
(with rubber coupling used)
 f_s : Maximum starting pulse rate with no load

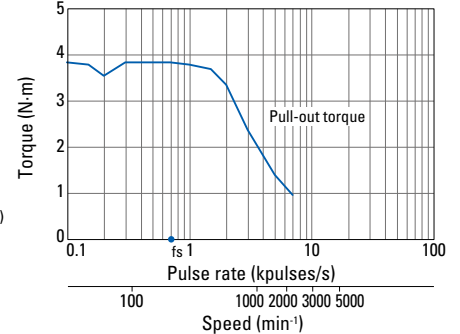

SH2863-0441 SH2863-0411

Constant current circuit
Input voltage: 100 VAC
Winding current:
2 A/phase
At 2-phase excitation (full step)
Pull-out torque:
 $J_L = 15.3 \times 10^{-4} \text{kg}\cdot\text{m}^2$
(with rubber coupling used)
 f_s : Maximum starting pulse rate with no load

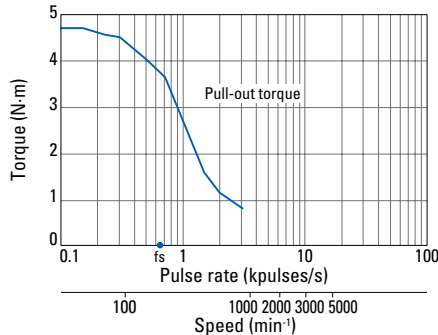

SH2863-0941 SH2863-0911

Constant current circuit
Input voltage: 100 VAC
Winding current:
4 A/phase
At 2-phase excitation (full step)
Pull-out torque:
 $J_L = 15.3 \times 10^{-4} \text{kg}\cdot\text{m}^2$
(with rubber coupling used)
 f_s : Maximum starting pulse rate with no load

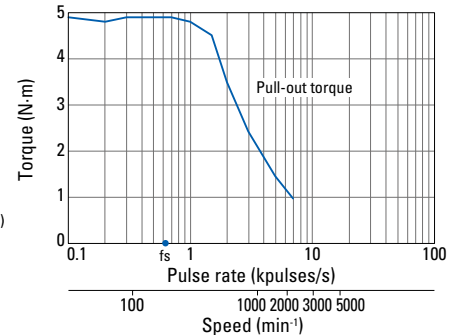

Dimensions (Unit: mm)

Lead type

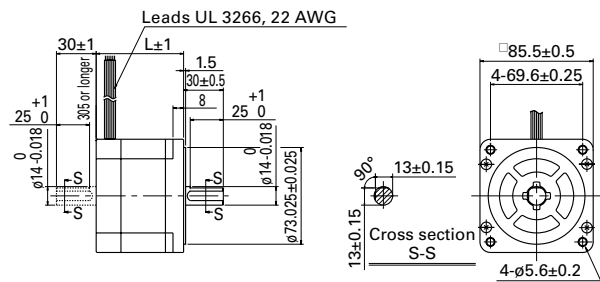

Internal winding

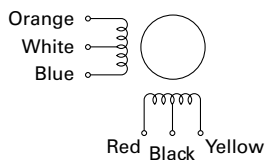

Compatible drivers

A driver is to be provided by the customer.

DC Input Set Orders and Drivers

Stepping Motors

IP65-Rated Stepping Motors

In-Vacuum Stepping Motors

Synchronous Motors

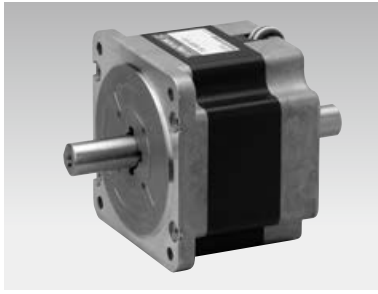

86 mm sq.

1.8°/step **RoHS**

Bipolar, lead type
Unipolar, lead type ▶ p. 58



Custom options

- Hollow shaft
- Custom shaft
- Encoder
- Brake

Note: Customization feasibility depends on the model number and quantity. Contact us for details.

Bipolar, lead type

Model no.		Holding torque at 2-phase excitation	Rated current	Winding resistance	Winding inductance	Rotor inertia	Mass	Motor length (L)
Single shaft	Dual shaft	N·m or more	A/phase	Ω/phase	mH/phase	×10 ⁻⁴ kg·m ²	kg	mm
SH2861-5041	SH2861-5011	3.3	2	2.2	15	1.48	1.75	66
SH2861-5141	SH2861-5111	3.3	4	0.56	3.7	1.48	1.75	66
SH2861-5241	SH2861-5211	3.3	6	0.29	1.7	1.48	1.75	66
SH2862-5041	SH2862-5011	6.4	2	3.2	25	3.0	2.9	96.5
SH2862-5141	SH2862-5111	6.4	4	0.83	6.4	3.0	2.9	96.5
SH2862-5241	SH2862-5211	6.4	6	0.36	2.8	3.0	2.9	96.5
SH2863-5041	SH2863-5011	9	2	4.0	32	4.5	4.0	127
SH2863-5141	SH2863-5111	9	4	1.0	7.9	4.5	4.0	127
SH2863-5241	SH2863-5211	9	6	0.46	3.8	4.5	4.0	127

Characteristics

SH2861-5041 SH2861-5011

Constant current circuit
Input voltage: 100 VAC
Winding current:
2 A/phase
At 2-phase excitation (full step)
Pull-out torque:
 $J_L = 15.3 \times 10^{-4} \text{kg}\cdot\text{m}^2$
(with rubber coupling used)
 f_s : Maximum starting pulse rate with no load

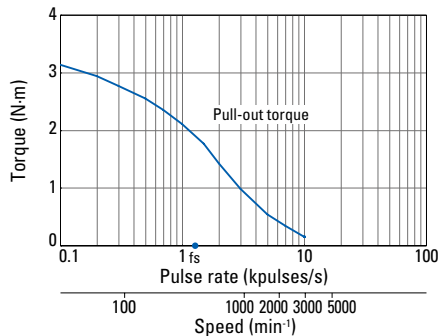

SH2861-5141 SH2861-5111

Constant current circuit
Input voltage: 100 VAC
Winding current:
4 A/phase
At 2-phase excitation (full step)
Pull-out torque:
 $J_L = 15.3 \times 10^{-4} \text{kg}\cdot\text{m}^2$
(with rubber coupling used)
 f_s : Maximum starting pulse rate with no load

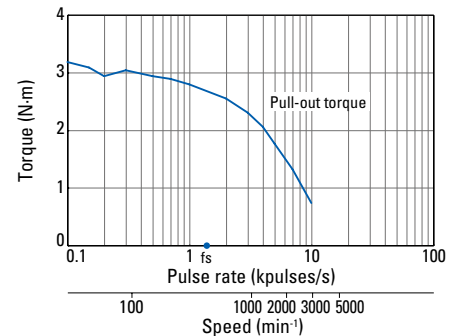

SH2861-5241 SH2861-5211

Constant current circuit
Input voltage: 100 VAC
Winding current:
6 A/phase
At 2-phase excitation (full step)
Pull-out torque:
 $J_L = 15.3 \times 10^{-4} \text{kg}\cdot\text{m}^2$
(with rubber coupling used)
 f_s : Maximum starting pulse rate with no load

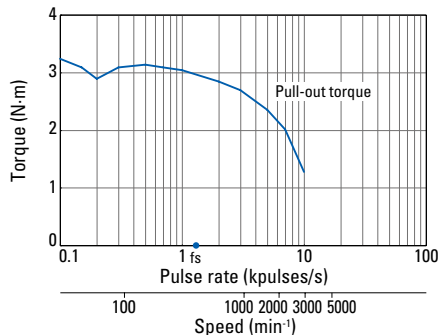

SH2862-5041 SH2862-5011

Constant current circuit
Input voltage: 100 VAC
Winding current:
2 A/phase
At 2-phase excitation (full step)
Pull-out torque:
 $J_L = 15.3 \times 10^{-4} \text{kg}\cdot\text{m}^2$
(with rubber coupling used)
 f_s : Maximum starting pulse rate with no load

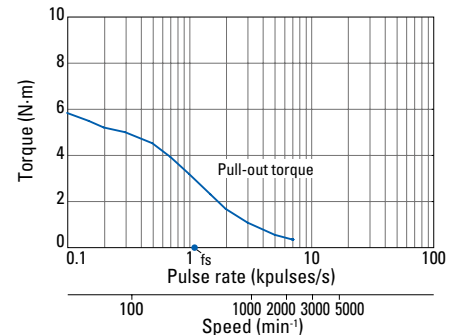

SH2862-5141 SH2862-5111

Constant current circuit
Input voltage: 100 VAC
Winding current:
4 A/phase
At 2-phase excitation (full step)
Pull-out torque:
 $J_L = 15.3 \times 10^{-4} \text{kg}\cdot\text{m}^2$
(with rubber coupling used)
 f_s : Maximum starting pulse rate with no load

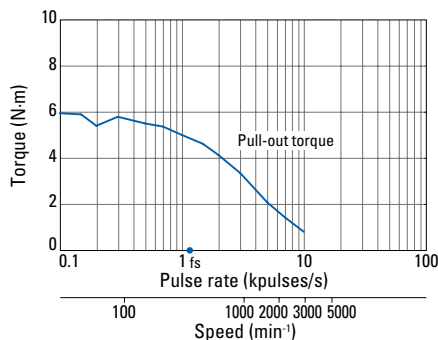

SH2862-5241 SH2862-5211

Constant current circuit
Input voltage: 100 VAC
Winding current:
6 A/phase
At 2-phase excitation (full step)
Pull-out torque:
 $J_L = 15.3 \times 10^{-4} \text{kg}\cdot\text{m}^2$
(with rubber coupling used)
 f_s : Maximum starting pulse rate with no load

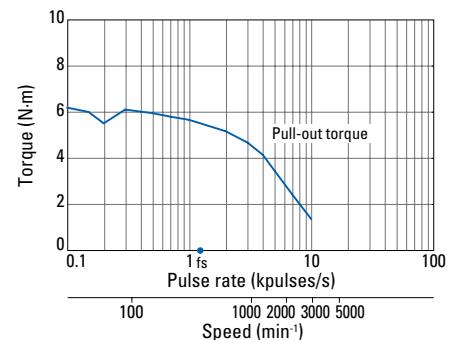

Characteristics

SH2863-5041 SH2863-5011

Constant current circuit
 Input voltage: 100 VAC
 Winding current:
 2 A/phase
 At 2-phase excitation (full step)
 Pull-out torque:
 $J_s = 44 \times 10^{-4} \text{kg}\cdot\text{m}^2$
 (with rubber coupling used)
 f_s : Maximum starting pulse rate with no load

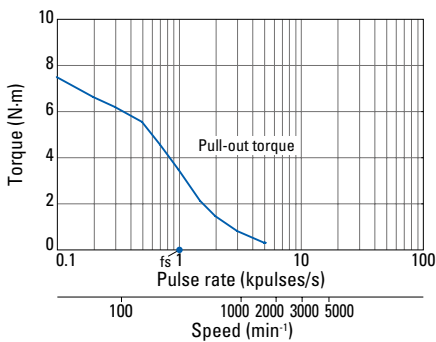

SH2863-5141 SH2863-5111

Constant current circuit
 Input voltage: 100 VAC
 Winding current:
 4 A/phase
 At 2-phase excitation (full step)
 Pull-out torque:
 $J_s = 44 \times 10^{-4} \text{kg}\cdot\text{m}^2$
 (with rubber coupling used)
 f_s : Maximum starting pulse rate with no load

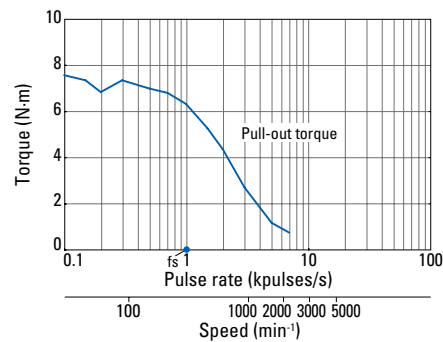

SH2863-5241 SH2863-5211

Constant current circuit
 Input voltage: 100 VAC
 Winding current:
 6 A/phase
 At 2-phase excitation (full step)
 Pull-out torque:
 $J_s = 44 \times 10^{-4} \text{kg}\cdot\text{m}^2$
 (with rubber coupling used)
 f_s : Maximum starting pulse rate with no load

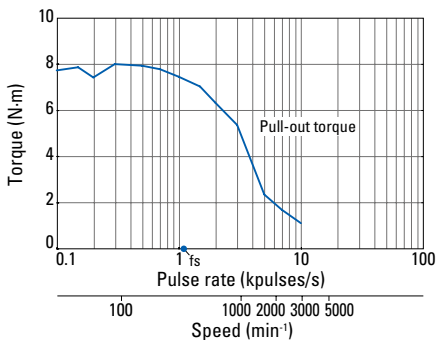

Dimensions (Unit: mm)

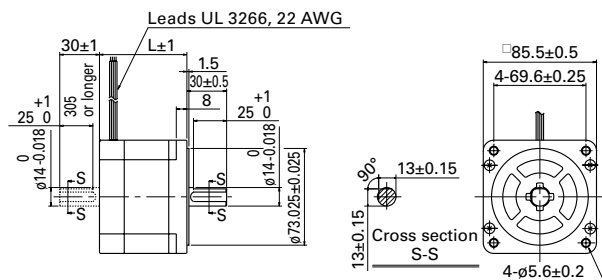

Internal winding

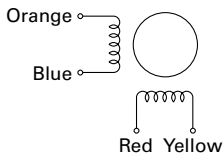

Compatible drivers

A driver is to be provided by the customer.

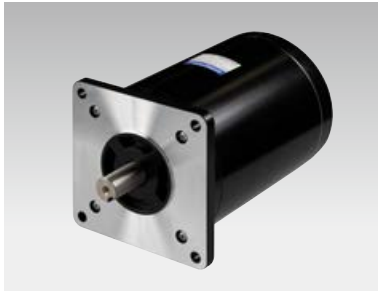

∅106 mm

1.8°/step RoHS

Unipolar, lead type
Bipolar, lead type

Custom options

- Hollow shaft Custom shaft
- Brake

Note: Customization feasibility depends on the model number and quantity. Contact us for details.

Unipolar, lead type

Model no.		Holding torque at 2-phase excitation	Rated current	Winding resistance	Winding inductance	Rotor inertia	Mass	Motor length (L)
Single shaft	Dual shaft	N·m or more	A/phase	Ω/phase	mH/phase	×10 ⁻⁴ kg·m ²	kg	mm
103H89222-0941	103H89222-0911	10.8	4	0.98	6.3	14.6	7.5	163.3
103H89223-0941	103H89223-0911	15.5	4	1.4	9.7	22	10.5	221.3

Bipolar, lead type

Model no.		Holding torque at 2-phase excitation	Rated current	Winding resistance	Winding inductance	Rotor inertia	Mass	Motor length (L)
Single shaft	Dual shaft	N·m or more	A/phase	Ω/phase	mH/phase	×10 ⁻⁴ kg·m ²	kg	mm
103H89222-5241	103H89222-5211	13.2	6	0.45	5.4	14.6	7.5	163.3
103H89223-5241	103H89223-5211	19	6	0.63	8	22	10.5	221.3

Characteristics

103H89222-0941 103H89222-0911

Constant current circuit
Input voltage: 100 VAC
Winding current:
4 A/phase
At 2-phase excitation (full step)
Pull-out torque:
 $J_L = 44 \times 10^{-4} \text{kg}\cdot\text{m}^2$
(with rubber coupling used)
 f_s : Maximum starting pulse rate with no load

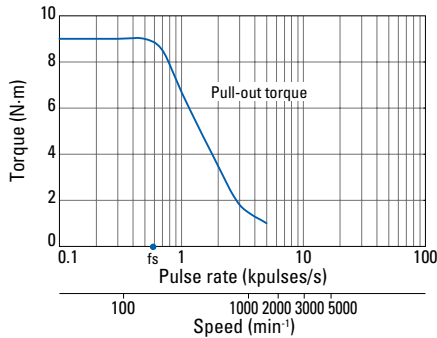

103H89223-0941 103H89223-0911

Constant current circuit
Input voltage: 100 VAC
Winding current:
4 A/phase
At 2-phase excitation (full step)
Pull-out torque:
 $J_L = 44 \times 10^{-4} \text{kg}\cdot\text{m}^2$
(with rubber coupling used)
 f_s : Maximum starting pulse rate with no load

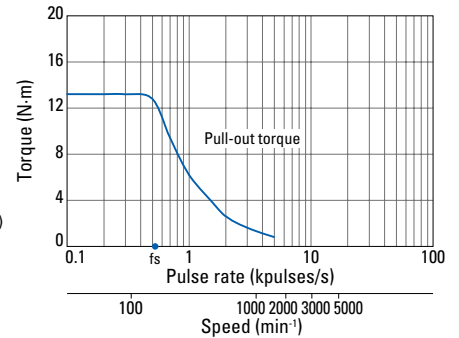

103H89222-5241 103H89222-5211

Constant current circuit
Input voltage: 100 VAC
Winding current:
6 A/phase
At 2-phase excitation (full step)
Pull-out torque:
 $J_L = 44 \times 10^{-4} \text{kg}\cdot\text{m}^2$
(with rubber coupling used)
 f_s : Maximum starting pulse rate with no load

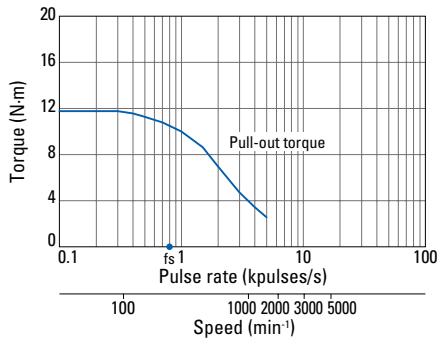

103H89223-5241 103H89223-5211

Constant current circuit
Input voltage: 100 VAC
Winding current:
6 A/phase
At 2-phase excitation (full step)
Pull-out torque:
 $J_L = 44 \times 10^{-4} \text{kg}\cdot\text{m}^2$
(with rubber coupling used)
 f_s : Maximum starting pulse rate with no load

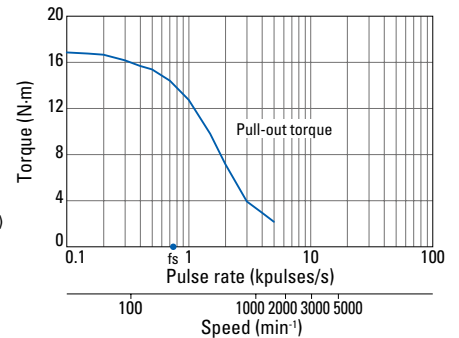

Dimensions (Unit: mm)

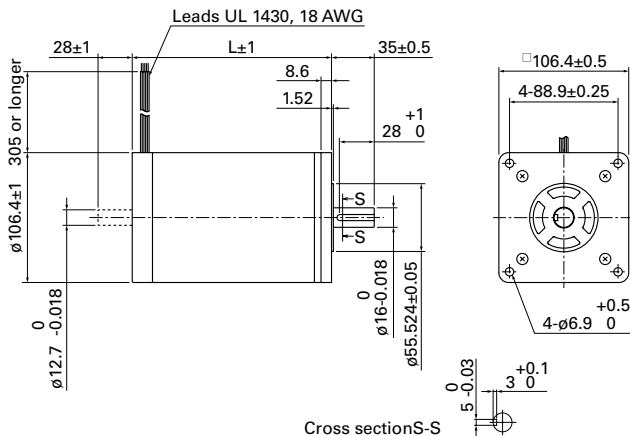

Internal winding

Unipolar

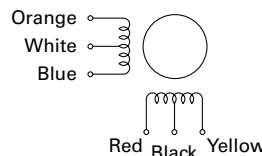

Bipolar

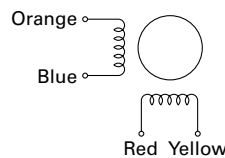

Compatible drivers

A driver is to be provided by the customer.



56 mm sq.

1.8°/step RoHS

Unipolar, lead-type, CE models



Custom options

Hollow shaft Custom shaft

Note: Customization feasibility depends on the model number and quantity. Contact us for details.

Unipolar, lead-type, CE models

Model no.		Holding torque at 2-phase excitation	Rated current	Winding resistance	Winding inductance	Rotor inertia	Mass	Motor length (L)
Single shaft	Dual shaft	N·m or more	A/phase	Ω/phase	mH/phase	×10 ⁻⁴ kg·m ²	kg	mm
103H7121-6140	103H7121-6110	0.39	1	4.8	8	0.1	0.47	41.8
103H7121-6740	103H7121-6710	0.39	3	0.6	0.8	0.1	0.47	41.8
103H7123-6140	103H7123-6110	0.83	1	6.7	15	0.21	0.65	53.8
103H7123-6740	103H7123-6710	0.78	3	0.77	1.58	0.21	0.65	53.8
103H7126-6140	103H7126-6110	1.27	1	8.6	19	0.36	0.98	75.8
103H7126-6740	103H7126-6710	1.27	3	0.9	2.2	0.36	0.98	75.8

Characteristics

103H7121-6140 103H7121-6110

Constant current circuit
Input voltage: 24 VDC
Winding current: 1 A/phase
At 2-phase excitation (full step)
Pull-out torque:
 $J_L = 0.94 \times 10^{-4} \text{kg}\cdot\text{m}^2$
(with rubber coupling used)
fs: Maximum starting pulse rate with no load

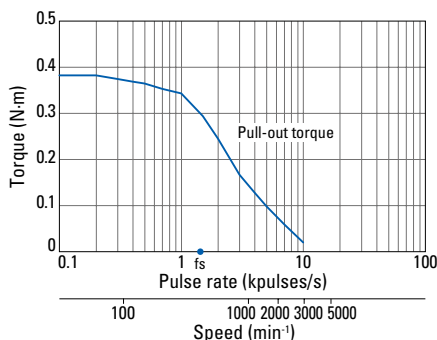

103H7121-6740 103H7121-6710

Constant current circuit
Input voltage: 24 VDC
Winding current: 3 A/phase
At 2-phase excitation (full step)
Pull-out torque:
 $J_L = 0.94 \times 10^{-4} \text{kg}\cdot\text{m}^2$
(with rubber coupling used)
fs: Maximum starting pulse rate with no load

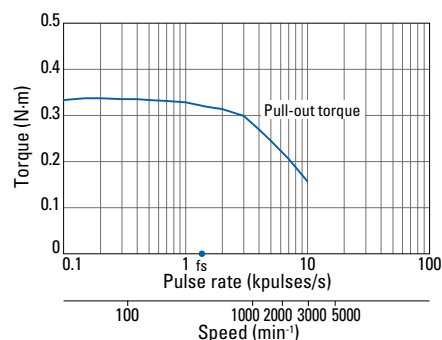

103H7123-6140 103H7123-6110

Constant current circuit
Input voltage: 24 VDC
Winding current: 1 A/phase
At 2-phase excitation (full step)
Pull-out torque:
 $J_L = 0.94 \times 10^{-4} \text{kg}\cdot\text{m}^2$
(with rubber coupling used)
fs: Maximum starting pulse rate with no load

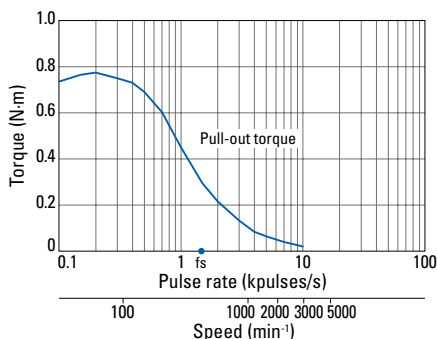

103H7123-6740 103H7123-6710

Constant current circuit
Input voltage: 24 VDC
Winding current: 3 A/phase
At 2-phase excitation (full step)
Pull-out torque:
 $J_L = 0.94 \times 10^{-4} \text{kg}\cdot\text{m}^2$
(with rubber coupling used)
fs: Maximum starting pulse rate with no load

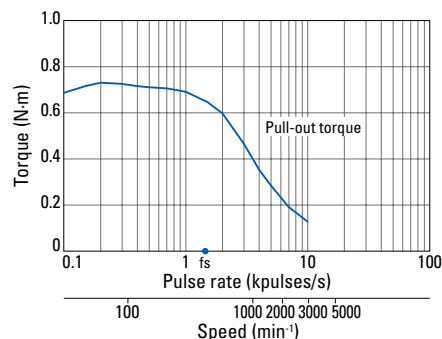

103H7126-6140 103H7126-6110

Constant current circuit
Input voltage: 24 VDC
Winding current: 1 A/phase
At 2-phase excitation (full step)
Pull-out torque:
 $J_L = 2.6 \times 10^{-4} \text{kg}\cdot\text{m}^2$
(with rubber coupling used)
fs: Maximum starting pulse rate with no load

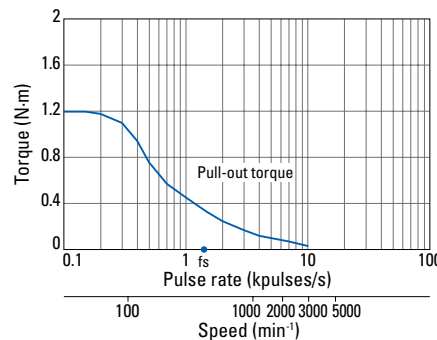

103H7126-6740 103H7126-6710

Constant current circuit
Input voltage: 24 VDC
Winding current: 3 A/phase
At 2-phase excitation (full step)
Pull-out torque:
 $J_L = 2.6 \times 10^{-4} \text{kg}\cdot\text{m}^2$
(with rubber coupling used)
fs: Maximum starting pulse rate with no load

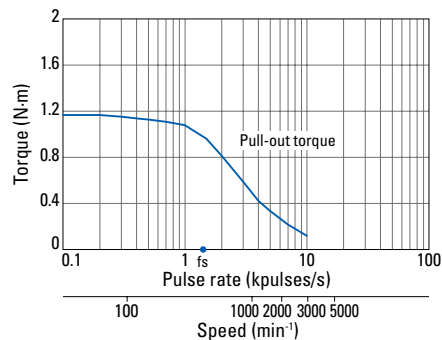

Dimensions (Unit: mm)

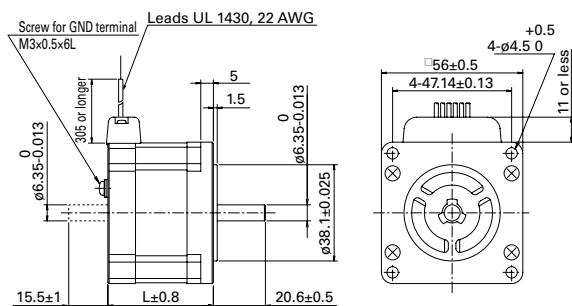

Internal winding

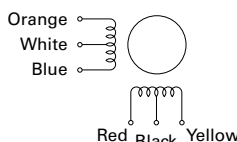

Compatible drivers

- For motors 103H712 □ -61 □ 0 (1 A/phase)...
Model no.: US1D200P10 (DC input)
Operating current selection switch setting: A
 - For motors other than above...
A driver is to be provided by the customer.
- Note: The characteristics shown above are calculated using our experimental circuit.

Allowable loads... ▶ p. 69 Internal wiring and rotational directions... ▶ p. 70

General specifications... ▶ p. 71

Data is measured under the drive conditions of SANYO DENKI. Drive torque may vary depending on the actual machine precision.



86 mm sq.

1.8°/step **RoHS**

Unipolar, lead-type, CE/UL models

Bipolar, lead-type, CE/UL models ▶ p. 66

Bipolar, terminal block-type, CE/UL models ▶ p. 66



Custom options

Hollow shaft **Custom shaft**

Note: Customization feasibility depends on the model number and quantity. Contact us for details.

Unipolar, lead-type, CE/UL models

Model no.		Holding torque at 2-phase excitation	Rated current	Winding resistance	Winding inductance	Rotor inertia	Mass	Motor length (L)
Single shaft	Dual shaft	N·m or more	A/phase	Ω/phase	mH/phase	×10 ⁻⁴ kg·m ²	kg	mm
SM2861-0451	SM2861-0421	2.5	2	2.3	8.0	1.48	1.75	66
SM2861-0951	SM2861-0921	2.5	4	0.6	2.0	1.48	1.75	66
SM2862-0451	SM2862-0421	4.7	2	3.2	13.0	3.0	2.9	96.5
SM2862-0951	SM2862-0921	4.7	4	0.85	3.4	3.0	2.9	96.5
SM2863-0451	SM2863-0421	6.7	2	4.0	17.0	4.5	4.0	127
SM2863-0951	SM2863-0921	6.7	4	0.9	4.2	4.5	4.0	127

Characteristics

SM2861-0451 SM2861-0421

Constant current circuit
Input voltage: 100 VAC
Winding current:
2 A/phase
At 2-phase excitation (full step)
Pull-out torque:
 $J_L = 7.4 \times 10^{-4} \text{kg}\cdot\text{m}^2$
(with rubber coupling used)
 f_s : Maximum starting pulse rate with no load

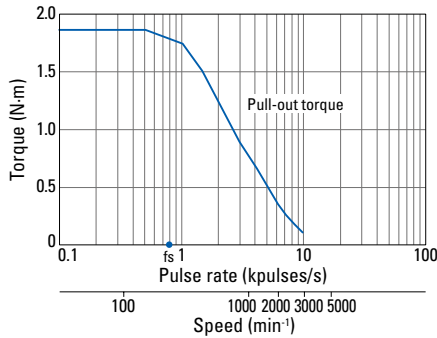

SM2861-0951 SM2861-0921

Constant current circuit
Input voltage: 100 VAC
Winding current:
4 A/phase
At 2-phase excitation (full step)
Pull-out torque:
 $J_L = 7.4 \times 10^{-4} \text{kg}\cdot\text{m}^2$
(with rubber coupling used)
 f_s : Maximum starting pulse rate with no load

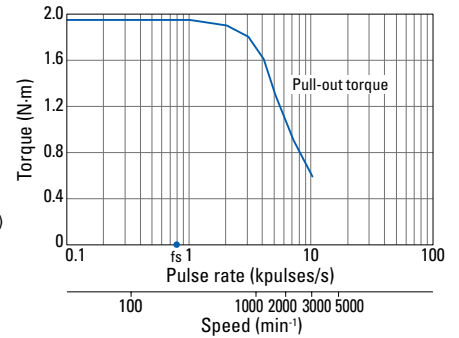

SM2862-0451 SM2862-0421

Constant current circuit
Input voltage: 100 VAC
Winding current:
2 A/phase
At 2-phase excitation (full step)
Pull-out torque:
 $J_L = 15.3 \times 10^{-4} \text{kg}\cdot\text{m}^2$
(with rubber coupling used)
 f_s : Maximum starting pulse rate with no load

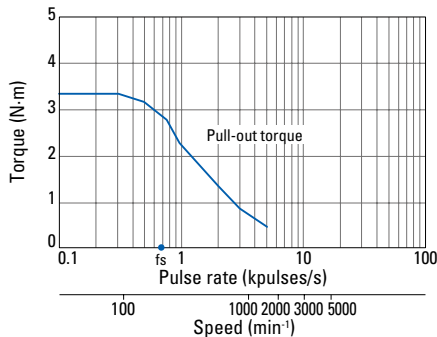

SM2862-0951 SM2862-0921

Constant current circuit
Input voltage: 100 VAC
Winding current:
4 A/phase
At 2-phase excitation (full step)
Pull-out torque:
 $J_L = 15.3 \times 10^{-4} \text{kg}\cdot\text{m}^2$
(with rubber coupling used)
 f_s : Maximum starting pulse rate with no load

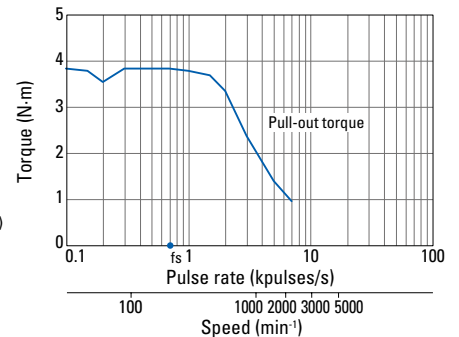

SM2863-0451 SM2863-0421

Constant current circuit
Input voltage: 100 VAC
Winding current:
2 A/phase
At 2-phase excitation (full step)
Pull-out torque:
 $J_L = 15.3 \times 10^{-4} \text{kg}\cdot\text{m}^2$
(with rubber coupling used)
 f_s : Maximum starting pulse rate with no load

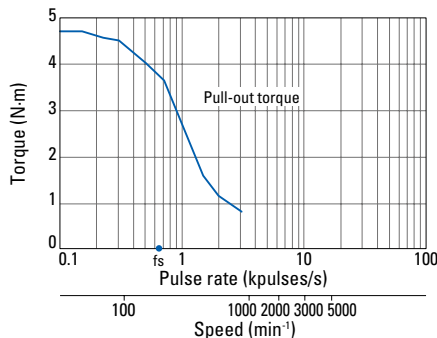

SM2863-0951 SM2863-0921

Constant current circuit
Input voltage: 100 VAC
Winding current:
4 A/phase
At 2-phase excitation (full step)
Pull-out torque:
 $J_L = 15.3 \times 10^{-4} \text{kg}\cdot\text{m}^2$
(with rubber coupling used)
 f_s : Maximum starting pulse rate with no load

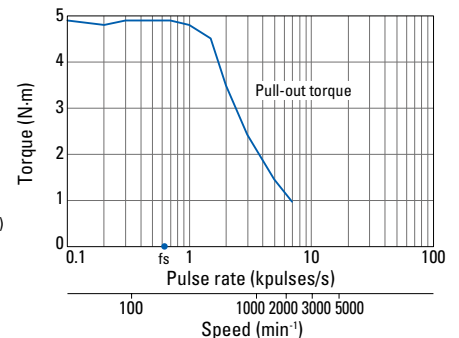

Dimensions (Unit: mm)

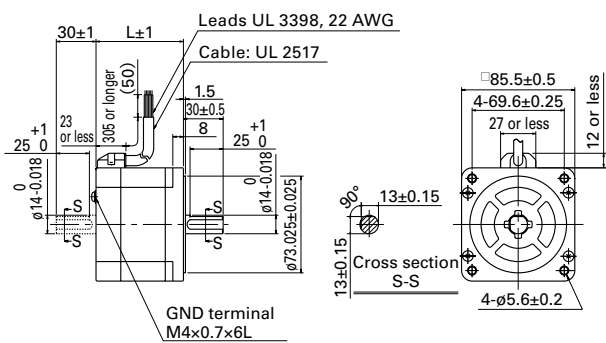

Internal winding

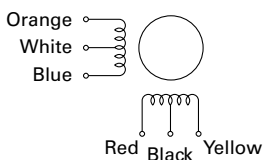

Compatible drivers

A driver is to be provided by the customer.

DC Input Set Orders and Drivers

Stepping Motors

IP65-Rated Stepping Motors

In-Vacuum Stepping Motors

Synchronous Motors



86 mm sq.

1.8°/step **RoHS**

Bipolar, lead-type, CE/UL models

Bipolar, terminal block-type, CE/UL models

Unipolar, lead-type, CE/UL models ▶ p. 64



Custom options

Hollow shaft Custom shaft

Encoder

Note: Customization feasibility depends on the model number and quantity. Contact us for details.

Bipolar, lead-type, CE/UL models

Model no.		Holding torque at 2-phase excitation N·m or more	Rated current A/phase	Winding resistance Ω/phase	Winding inductance mH/phase	Rotor inertia ×10 ⁻⁴ kg·m ²	Mass kg	Motor length (L) mm
Single shaft	Dual shaft							
SM2861-5051	SM2861-5021	3.3	2	2.2	15	1.48	1.75	66
SM2861-5151	SM2861-5121	3.3	4	0.56	3.7	1.48	1.75	66
SM2861-5251	SM2861-5221	3.3	6	0.29	1.7	1.48	1.75	66
SM2862-5051	SM2862-5021	6.4	2	3.2	25	3.0	2.9	96.5
SM2862-5151	SM2862-5121	6.4	4	0.83	6.4	3.0	2.9	96.5
SM2862-5251	SM2862-5221	6.4	6	0.36	2.8	3.0	2.9	96.5
SM2863-5051	SM2863-5021	9	2	4.0	32	4.5	4.0	127
SM2863-5151	SM2863-5121	9	4	1.0	7.9	4.5	4.0	127
SM2863-5251	SM2863-5221	9	6	0.46	3.8	4.5	4.0	127

Bipolar, terminal block-type, CE/UL models

Model no.		Holding torque at 2-phase excitation N·m or more	Rated current A/phase	Winding resistance Ω/phase	Winding inductance mH/phase	Rotor inertia ×10 ⁻⁴ kg·m ²	Mass kg	Motor length (L) mm
Single shaft								
SM2861-5066		3.3	2	2.03	15	1.48	1.9	97.9
SM2861-5166		3.3	4	0.52	3.7	1.48	1.9	97.9
SM2861-5266		3.3	6	0.27	1.7	1.48	1.9	97.9
SM2862-5066		6.4	2	3.08	25	3.0	3.05	128.4
SM2862-5166		6.4	4	0.79	6.4	3.0	3.05	128.4
SM2862-5266		6.4	6	0.33	2.8	3.0	3.05	128.4
SM2863-5066		9	2	3.83	32	4.5	4.15	158.8
SM2863-5166		9	4	0.96	7.9	4.5	4.15	158.8
SM2863-5266		9	6	0.48	3.8	4.5	4.15	158.8

Characteristics

SM2861-5051 SM2861-5021

SM2861-5066

Constant current circuit
Input voltage: 100 VAC
Winding current:
2 A/phase
At 2-phase excitation (full step)
Pull-out torque:
 $J_L = 15.3 \times 10^{-4} \text{kg}\cdot\text{m}^2$
(with rubber coupling used)
 f_s : Maximum starting pulse rate with no load

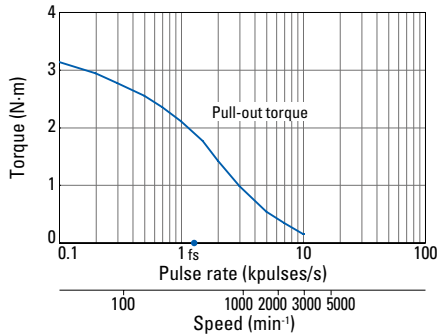

SM2861-5151 SM2861-5121

SM2861-5166

Constant current circuit
Input voltage: 100 VAC
Winding current:
4 A/phase
At 2-phase excitation (full step)
Pull-out torque:
 $J_L = 15.3 \times 10^{-4} \text{kg}\cdot\text{m}^2$
(with rubber coupling used)
 f_s : Maximum starting pulse rate with no load

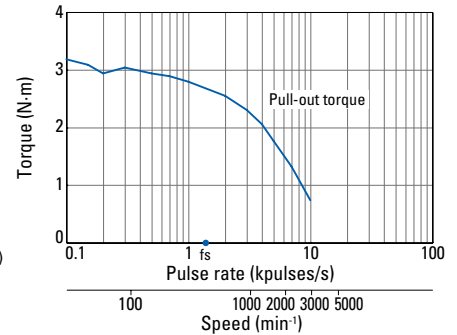

SM2861-5251 SM2861-5221

SM2861-5266

Constant current circuit
Input voltage: 100 VAC
Winding current:
6 A/phase
At 2-phase excitation (full step)
Pull-out torque:
 $J_L = 15.3 \times 10^{-4} \text{kg}\cdot\text{m}^2$
(with rubber coupling used)
 f_s : Maximum starting pulse rate with no load

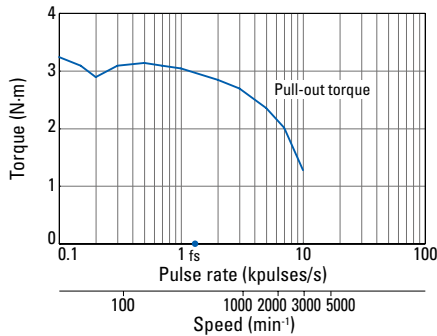

SM2862-5051 SM2862-5021

SM2862-5066

Constant current circuit
Input voltage: 100 VAC
Winding current:
2 A/phase
At 2-phase excitation (full step)
Pull-out torque:
 $J_L = 15.3 \times 10^{-4} \text{kg}\cdot\text{m}^2$
(with rubber coupling used)
 f_s : Maximum starting pulse rate with no load

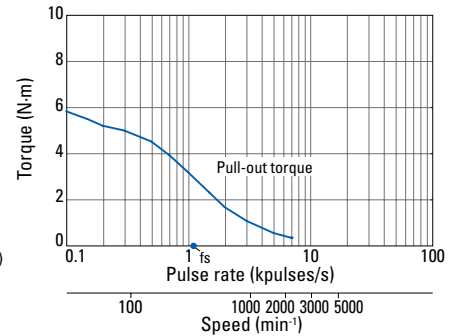

Characteristics

SM2862-5151 SM2862-5121

SM2862-5166

Constant current circuit
Input voltage: 100 VAC
Winding current:
4 A/phase
At 2-phase excitation (full step)
Pull-out torque:
 $J_L = 15.3 \times 10^{-4} \text{kg}\cdot\text{m}^2$
(with rubber coupling used)
 f_s : Maximum starting pulse rate with no load

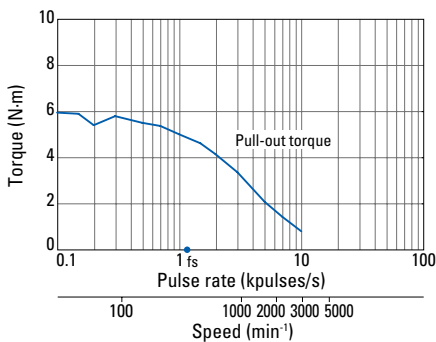

SM2862-5251 SM2862-5221

SM2862-5066

Constant current circuit
Input voltage: 100 VAC
Winding current:
6 A/phase
At 2-phase excitation (full step)
Pull-out torque:
 $J_L = 15.3 \times 10^{-4} \text{kg}\cdot\text{m}^2$
(with rubber coupling used)
 f_s : Maximum starting pulse rate with no load

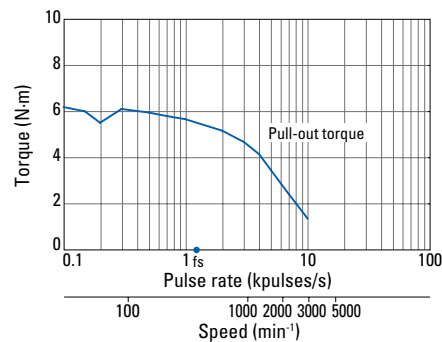

SM2863-5051 SM2863-5021

SM2863-5066

Constant current circuit
Input voltage: 100 VAC
Winding current:
2 A/phase
At 2-phase excitation (full step)
Pull-out torque:
 $J_L = 44 \times 10^{-4} \text{kg}\cdot\text{m}^2$
(with rubber coupling used)
 f_s : Maximum starting pulse rate with no load

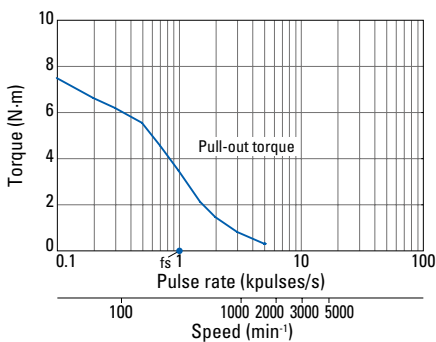

SM2863-5151 SM2863-5121

SM2863-5166

Constant current circuit
Input voltage: 100 VAC
Winding current:
4 A/phase
At 2-phase excitation (full step)
Pull-out torque:
 $J_L = 44 \times 10^{-4} \text{kg}\cdot\text{m}^2$
(with rubber coupling used)
 f_s : Maximum starting pulse rate with no load

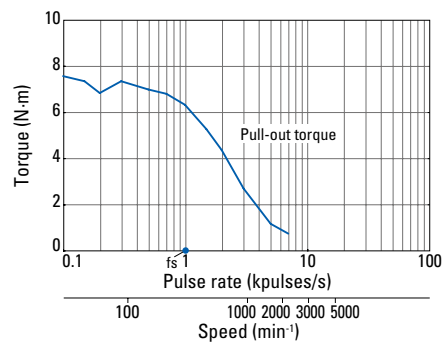

SM2863-5251 SM2863-5221

SM2863-5266

Constant current circuit
Input voltage: 100 VAC
Winding current:
6 A/phase
At 2-phase excitation (full step)
Pull-out torque:
 $J_L = 44 \times 10^{-4} \text{kg}\cdot\text{m}^2$
(with rubber coupling used)
 f_s : Maximum starting pulse rate with no load

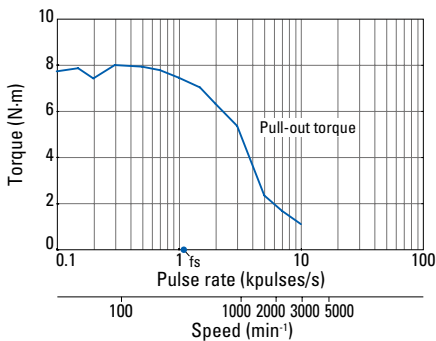

Dimensions (Unit: mm)

Lead type

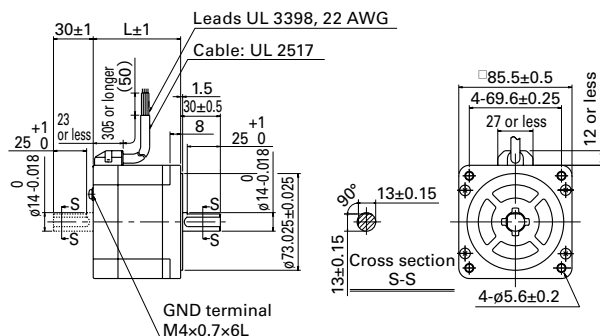

Terminal block type

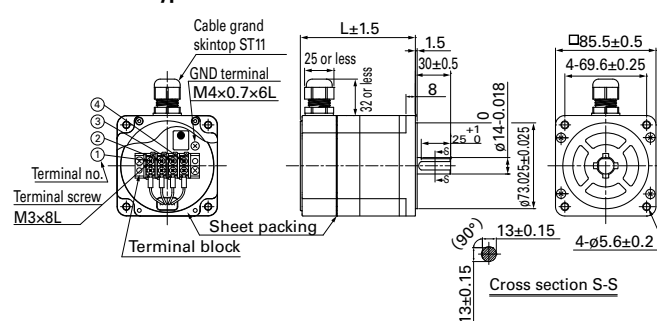

Internal winding

Lead type

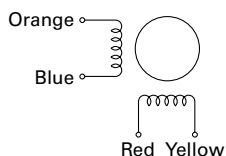

Terminal block type

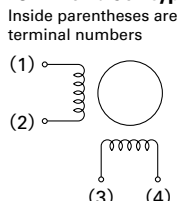

Compatible drivers

A driver is to be provided by the customer.



∅106 mm

1.8°/step **RoHS**

Bipolar, lead type, CE models



Custom options

Hollow shaft **Custom shaft**

Note: Customization feasibility depends on the model number and quantity. Contact us for details.

Bipolar, lead type, CE models

Model no.		Holding torque at 2-phase excitation	Rated current	Winding resistance	Winding inductance	Rotor inertia	Mass	Motor length (L)
Single shaft	Dual shaft	N·m or more	A/phase	Ω/phase	mH/phase	×10 ⁻⁴ kg·m ²	kg	mm
103H89222-6341	103H89222-6311	13.2	6	0.45	5.4	14.6	7.5	163.3
103H89223-6341	103H89223-6311	19	6	0.63	8	22	10.5	221.3

Characteristics

103H89222-6341 103H89222-6311

Constant current circuit
Input voltage: 100 VAC
Winding current:
6 A/phase
At 2-phase excitation (full step)
Pull-out torque:
 $J_L = 44 \times 10^{-4} \text{kg}\cdot\text{m}^2$
(with rubber coupling used)
 f_s : Maximum starting pulse rate with no load

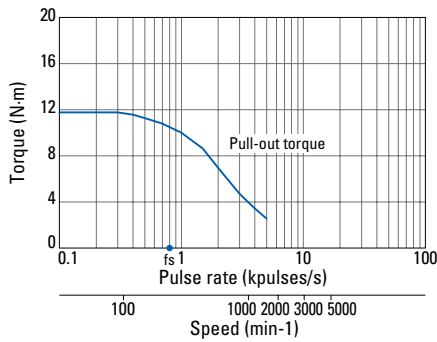

103H89223-6341 103H89223-6311

Constant current circuit
Input voltage: 100 VAC
Winding current:
6 A/phase
At 2-phase excitation (full step)
Pull-out torque:
 $J_L = 44 \times 10^{-4} \text{kg}\cdot\text{m}^2$
(with rubber coupling used)
 f_s : Maximum starting pulse rate with no load

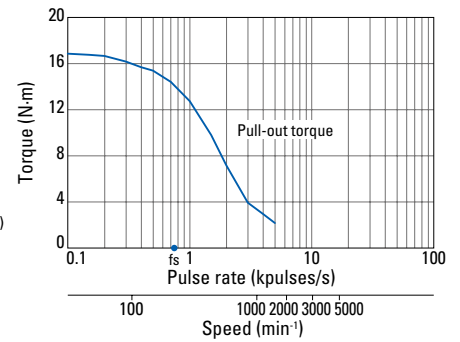

Dimensions (Unit: mm)

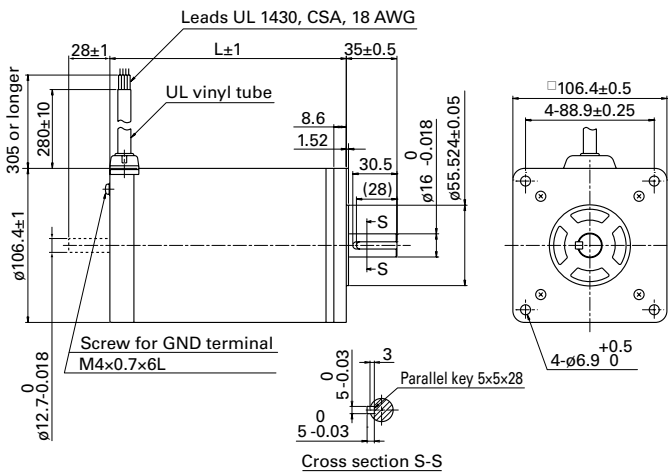

Internal winding

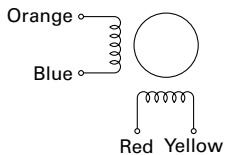

Compatible drivers

A driver is to be provided by the customer.

Allowable Radial and Thrust Loads

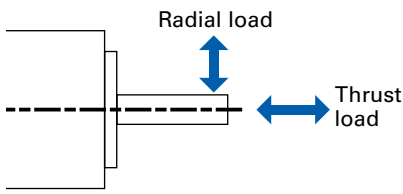

Motor size	Model no.	Distance from shaft end (mm)				Thrust load (N)
		0	5	10	15	
		Radial load (N)				
14 mm sq.	SH214 □	10	10	10	–	0.7
28 mm sq.	SH2281	42	42	42	–	3
	SH2285	49	49	49	–	
35 mm sq.	SH35 □□	40	51	67	90	10
42 mm sq.	SF242 □	20	29	47	64	10
	SH142 □	20	25	32	37	
	SS242 □ -50 □ 1	10	–	–	–	4.9
	SS242 □ -50 □ 00	25	25	–	–	
50 mm sq.	103H670 □	74	91	120	174	15
	SS250 □	8.5	–	–	–	4.9
56 mm sq.	SM256 □	70	87	114	166	20
60 mm sq.	SH160 □	65	86	129	210	15
	SH1603	83	103	135	197	
86 mm sq.	SM286 □	200	200	200	200	60
	SH286 □					
*106 mm	103H8922 □	321	356	400	457	100

Internal Wiring and Rotational Directions

Unipolar winding

Connector type, model no.: SF242

Internal wiring

In parentheses are lead colors of the motor cable

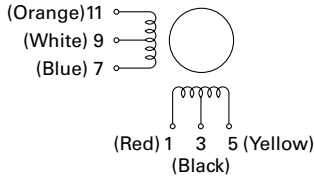

Direction of motor rotation

When excited by a direct current in the order shown below, the direction of rotation is clockwise as viewed from the output shaft side.

		Connector pin no.				
		3, 9	1	7	5	11
Excitation sequence	1	+	-	-	-	-
	2	+	-	-	-	-
	3	+	-	-	-	-
	4	+	-	-	-	-

Connector type, model no.: SM256 (and 103H782)

Internal wiring

In parentheses are lead colors of the motor cable

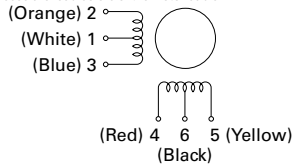

Direction of motor rotation

When excited by a direct current in the order shown below, the direction of rotation is clockwise as viewed from the output shaft side.

		Connector pin no.				
		1, 6	4	3	5	2
Excitation sequence	1	+	-	-	-	-
	2	+	-	-	-	-
	3	+	-	-	-	-
	4	+	-	-	-	-

Lead type

Internal wiring

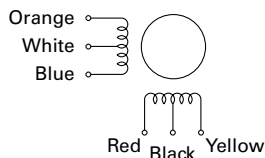

Direction of motor rotation

When excited by a direct current in the order shown below, the direction of rotation is clockwise as viewed from the output shaft side.

		Lead color				
		White, Black	Red	Blue	Yellow	Orange
Excitation sequence	1	+	-	-	-	-
	2	+	-	-	-	-
	3	+	-	-	-	-
	4	+	-	-	-	-

Bipolar winding

Connector type, model no.: SF242

Internal wiring

In parentheses are lead colors of the motor cable

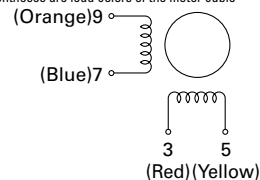

Direction of motor rotation

When excited by a direct current in the order shown below, the direction of rotation is clockwise as viewed from the output shaft side.

		Connector pin no.				
		3	7	5	9	
Excitation sequence	1	-	-	+	+	
	2	+	-	-	+	
	3	+	+	-	-	
	4	-	+	+	-	

Connector type, model no.: SM256 (and 103H782)

Internal wiring

In parentheses are lead colors of the motor cable

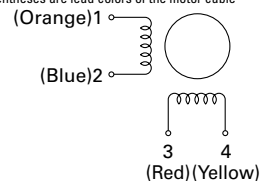

Direction of motor rotation

When excited by a direct current in the order shown below, the direction of rotation is clockwise as viewed from the output shaft side.

		Connector pin no.			
		3	2	4	1
Excitation sequence	1	-	-	+	+
	2	+	-	-	+
	3	+	+	-	-
	4	-	+	+	-

Lead type

Internal wiring

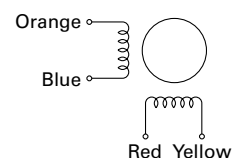

Direction of motor rotation

When excited by a direct current in the order shown below, the direction of rotation is clockwise as viewed from the output shaft side.

		Lead color			
		Red	Blue	Yellow	Orange
Excitation sequence	1	-	-	+	+
	2	+	-	-	+
	3	+	+	-	-
	4	-	+	+	-

General Specifications

Motor model no.	SH214 <input type="checkbox"/>	SH228 <input type="checkbox"/>	SH353 <input type="checkbox"/>	SS242 <input type="checkbox"/>	SH142 <input type="checkbox"/>	SF242 <input type="checkbox"/>	SS250 <input type="checkbox"/>	103H670 <input type="checkbox"/>
Operation type	-							
Operating ambient temperature	-10 to +50°C							
Storage temperature	-20 to +65°C							
Operating ambient humidity	20 to 90% RH (non-condensing)							
Storage humidity	5 to 95 % RH (non-condensing)							
Operating altitude	Up to 1000 m above sea level							
Vibration resistance	Frequency 10 to 500 Hz, amplitude 1.52 mm (10 to 70 Hz), vibration acceleration 150 m/s ² (70 to 500 Hz), sweep time 15 min/cycle, a total of 12 tests in both opposite directions for each of X, Y, and Z axes.							
Shock resistance	Acceleration 500 m/s ² , duration 11 ms, half sine wave, tested 3 times in both directions for each X, Y, and Z axis for a total of 18 times							
Thermal class	B (+130°C)							
Dielectric strength	No abnormality after application of 500 VAC at 50/60 Hz between the motor winding and motor frame for one minute at normal temperature and humidity.							No abnormality after application of 1000 VAC at 50/60 Hz between the motor winding and motor frame for one minute at normal temperature and humidity.
Insulation resistance	100 MΩ or more with a 500 VDC megger between the motor winding and motor frame at normal temperature and humidity.							
Protection rating	-							
Winding temperature rise	80 K or less (based on our own standard)							
Positional accuracy	±0.09°				±0.054°		±0.09°	
Thrust play ⁽¹⁾	0.075 mm or less (With a 0.35 N load)	0.075 mm or less (With a 1.5 N load)	0.075 mm or less (With a 5 N load)	0.075 mm or less (With a 4 N load)	0.075 mm or less (With a 5 N load)	0.075 mm (With a 5 N load)	0.075 mm or less (With a 4 N load)	0.075 mm (With a 10 N load)
Radial play ⁽²⁾	0.025 mm (With a 5 N load)							
Shaft runout	0.025 mm							
Concentricity of motor shaft and fitting part	ø0.05 mm	ø0.05 mm	ø0.075 mm	ø0.075 mm	ø0.05 mm	ø0.05 mm	ø0.075 mm	ø0.075 mm
Perpendicularity of mounting surface and motor shaft	0.1 mm	0.1 mm	0.1 mm	0.1 mm	0.1 mm	0.1 mm	0.1 mm	0.1 mm
Motor mounting orientation	Can be installed vertically or horizontally.							

Motor model no.	SM256 <input type="checkbox"/> UL models	SH160 <input type="checkbox"/>	SH286 <input type="checkbox"/>	103H8922 <input type="checkbox"/>	SM286 <input type="checkbox"/> CE/UL models	103H712 <input type="checkbox"/> -6 <input type="checkbox"/> 0 <input type="checkbox"/> 0	103H8922 <input type="checkbox"/> -63 <input type="checkbox"/> 1	
Operation type	-							Continuous operation (S1)
Operating ambient temperature	-10 to +50°C				-10 to +40°C			
Storage temperature	-20 to +65°C				-20 to +60°C			
Operating ambient humidity	20 to 90% RH (non-condensing)				95% RH or less: Below 40°C (non-condensing)			
Storage humidity	5 to 95 % RH (non-condensing)				95% RH or less: Below 40°C, 57% RH or less: Below 50°C, 35% RH or less: Below 60°C, (non-condensing)			
Operating altitude	Up to 1000 m above sea level							
Vibration resistance	Frequency 10 to 500 Hz, amplitude 1.52 mm (10 to 70 Hz), vibration acceleration 150 m/s ² (70 to 500 Hz), sweep time 15 min/cycle, a total of 12 tests in both opposite directions for each of X, Y, and Z axes.							
Shock resistance	Acceleration 500 m/s ² , duration 11 ms, half sine wave, tested 3 times in both directions for each X, Y, and Z axis for a total of 18 times							
Thermal class	B (+130°C) (A for UL models)		B (+130°C)			F (+155°C)	B (+130°C)	
Dielectric strength	No abnormality after application of 1120 VAC at 50/60 Hz between the motor winding and motor frame for one minute at normal temperature and humidity.		No abnormality after application of 1000 VAC at 50/60 Hz between the motor winding and motor frame for one minute at normal temperature and humidity.		No abnormality after application of 1500 VAC at 50/60 Hz between the motor winding and motor frame for one minute at normal temperature and humidity.			
Insulation resistance	100 MΩ or more with a 500 VDC megger between the motor winding and motor frame at normal temperature and humidity.							
Protection rating	-					IP43		
Winding temperature rise	80 K or less (based on our own standard)							
Positional accuracy tolerance	±0.054°			±0.09°		±0.054°		±0.09°
Thrust play ⁽¹⁾	0.075 mm (With a 10 N load)							
Radial play ⁽²⁾	0.025 mm (With a 5 N load)		0.025 mm (With a 5 N load)	0.025 mm (With a 5 N load)	0.025 mm (With a 10 N load)	0.025 mm (With a 5 N load)	0.025 mm (With a 5 N load)	0.025 mm (With a 10 N load)
Runout of shaft	0.025 mm							
Concentricity of motor shaft and fitting part	ø0.075 mm							
Perpendicularity of mounting surface and motor shaft	0.1 mm		0.1 mm	0.15 mm	0.1 mm	0.15 mm	0.1 mm	0.1 mm
Motor mounting orientation	Can be installed vertically or horizontally.							

(1) Thrust play: Maximum shaft position displacement when a load is exerted in a direction parallel to the motor shaft.
 (2) Radial play: Maximum shaft position displacement when a load is exerted in a direction perpendicular to the motor shaft.

Safety standards

Model no.: SM256 UL models

UL	Classification	Standards	File no.
	UL	UL 1004-1, UL 1004-6	E179832
	UL for Canada (cUL)	CSA C22.2 No. 100	

Model no.: 103H712 -6 0 0, 103H8922 -63 1 CE models

CE (TÜV)	Directive	Standards
	Low Voltage Directive	EN 60034-1, EN 60034-5

Model no.: SM286 CE/UL models

CE (TÜV)	Directive	Standards
	Low Voltage Directive	EN 60034-1, EN 60034-5

UL	Classification	Standards	File no.
	UL	UL 1004-1, UL 1004-6	E179832
	UL for Canada (cUL)	CSA C22.2 No. 100	

IP65-Rated Stepping Motors

Water and dust protection

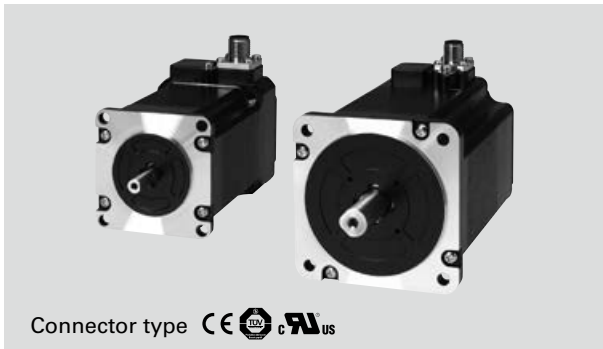
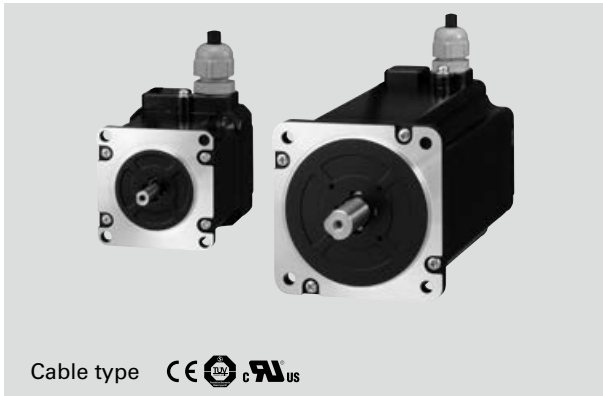

Features

- These IP65-rated motors* have superior water and dust resistance, and can be safely used in water-exposed environments such as in food processing machines.
- * Except for the shaft and cable ends.
- Options such as a brake, encoder, and oil seal can be combined.

Safety standards

- In compliant with CE/UL safety standards.

Specifications

	56 mm sq.	86 mm sq.
Motor model no.	SP256□-5□□0	SP286□-5□□0
Operation type	Continuous operation (S1)	
Operating ambient temperature	-10 to +40°C	
Storage temperature	-20 to +60°C	
Operating ambient humidity	95% RH or less: Below 40°C (non-condensing)	
Storage humidity	95% RH or less: Below 40°C, 57% RH or less: Below 50°C, 35% RH or less: Below 60°C, (non-condensing)	
Operating altitude	Up to 1000 m above sea level	
Vibration resistance	Frequency 10 to 500 Hz, amplitude 1.52 mm (10 to 70 Hz), vibration acceleration 150 m/s ² (70 to 500 Hz), sweep time 15 min/cycle, a total of 12 tests in both opposite directions for each of X, Y, and Z axes.	
Shock resistance	Acceleration 500 m/s ² , duration 11 ms, half sine wave, tested 3 times in both directions for each X, Y, and Z axis for a total of 18 times	
Thermal class	F (+155°C)	
Dielectric strength	No abnormality after application of 1500 VAC at 50/60 Hz between the motor winding and motor frame for one minute at normal temperature and humidity.	
Insulation resistance	100 M Ω or more with a 500 VDC megger between the motor winding and motor frame at normal temperature and humidity.	
Protection rating	IP65 (excluding the hollow shaft part and cable ends)	
Winding temperature rise	100 K or less (based on our own standard)	
Positional accuracy tolerance	± 0.054°	± 0.09°
Thrust play	0.075 mm or less (With a 10 N load)	
Radial play	0.025 mm or less (With a 5 N load)	
Runout of shaft	0.025 mm	
Concentricity of motor shaft and fitting part	ø0.075 mm	
Perpendicularity of mounting surface and motor shaft	0.1 mm	0.15 mm
Motor mounting orientation	Can be installed vertically or horizontally.	

Internal Wiring and Rotational Directions

Bipolar winding

Internal wiring

In parentheses are connector pin nos.

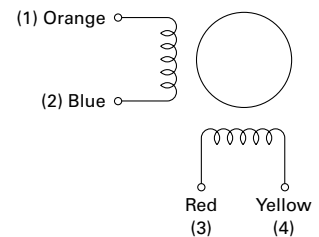

Rotating direction

When excited by a direct current in the order shown below, the direction of rotation is clockwise as viewed from the output shaft side.

Lead color	Red	Blue	Yellow	Orange
Connector pin no.	3	2	4	1
Excitation sequence	1	-	-	+
	2	+	-	-
	3	+	+	-
	4	-	+	+

Safety standards

CE	Directive	Standards	
	Low Voltage Directive	EN 60034-1, EN 60034-5	
UL	Classification	Standards	File no.
	UL	UL 1004-1, UL 1004-6	E179832
	UL for Canada (cUL)	CSA C22.2 No. 100	

Models with brake or oil seal have different model nos.

Models with an encoder have different model nos. and vibration resistance.

56 mm sq.

1.8°/step RoHS

Bipolar



Custom options

Custom shaft

Note: Customization feasibility depends on the model number and quantity. Contact us for details.

Model no.	Holding torque at 2-phase excitation	Rated current	Winding resistance	Winding inductance	Rotor inertia	Mass	Allowable thrust load	Allowable radial load
Cable type	Connector type	N-m or more	A/phase	Ω/phase	mH/phase	×10 ⁻⁴ kg·m ²	N	N
SP2563-5060	SP2563-5000	1	1	5.8	29	0.21	0.9	15
SP2563-5160	SP2563-5100	1	2	1.5	7.3	0.21	0.9	15
SP2563-5260	SP2563-5200	1	3	0.75	3.4	0.21	0.9	15
SP2566-5060	SP2566-5000	1.7	1	7.8	35.4	0.36	1.2	15
SP2566-5160	SP2566-5100	1.7	2	2	9.2	0.36	1.2	15
SP2566-5260	SP2566-5200	1.7	3	1	4.4	0.36	1.2	15

• Models with a brake, encoder, or oil seal have different model nos., rotor inertia, and mass.

Characteristics

SP2563-5000
SP2563-5060

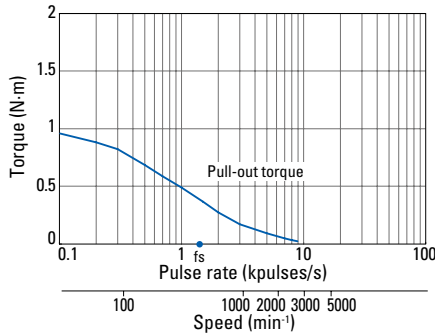

Constant current circuit
Input voltage: 100 VAC
Winding current: 1 A/phase, At 2-phase excitation (full step)
Pull-out torque: $J_L=2.6 \times 10^{-4} \text{kg}\cdot\text{m}^2$ (with rubber coupling used)
fs: Maximum starting pulse rate with no load

SP2563-5100
SP2563-5160

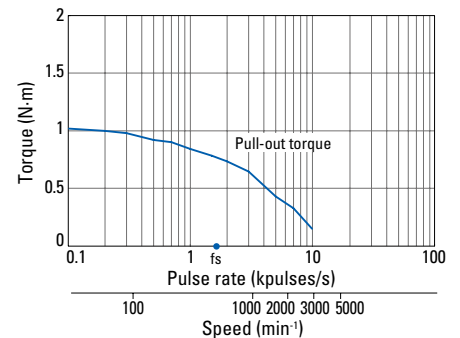

Constant current circuit
Input voltage: 100 VAC
Winding current: 2 A/phase, At 2-phase excitation (full step)
Pull-out torque: $J_L=2.6 \times 10^{-4} \text{kg}\cdot\text{m}^2$ (with rubber coupling used)
fs: Maximum starting pulse rate with no load

SP2563-5200
SP2563-5260

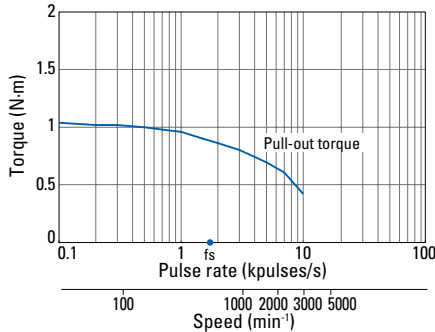

Constant current circuit
Input voltage: 100 VAC
Winding current: 3 A/phase, At 2-phase excitation (full step)
Pull-out torque: $J_L=2.6 \times 10^{-4} \text{kg}\cdot\text{m}^2$ (with rubber coupling used)
fs: Maximum starting pulse rate with no load

SP2566-5000
SP2566-5060

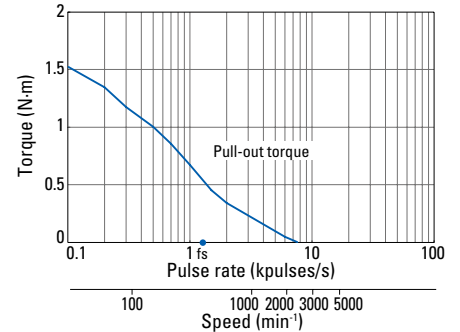

Constant current circuit
Input voltage: 100 VAC
Winding current: 1 A/phase, At 2-phase excitation (full step)
Pull-out torque: $J_L=7.4 \times 10^{-4} \text{kg}\cdot\text{m}^2$ (with rubber coupling used)
fs: Maximum starting pulse rate with no load

SP2566-5100
SP2566-5160

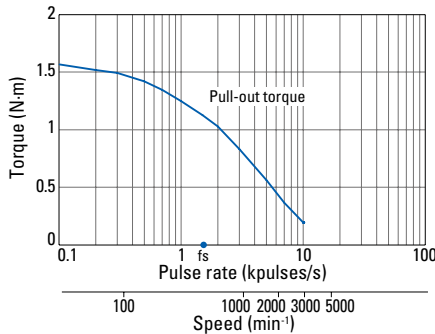

Constant current circuit
Input voltage: 100 VAC
Winding current: 2 A/phase, At 2-phase excitation (full step)
Pull-out torque: $J_L=7.4 \times 10^{-4} \text{kg}\cdot\text{m}^2$ (with rubber coupling used)
fs: Maximum starting pulse rate with no load

SP2566-5200
SP2566-5260

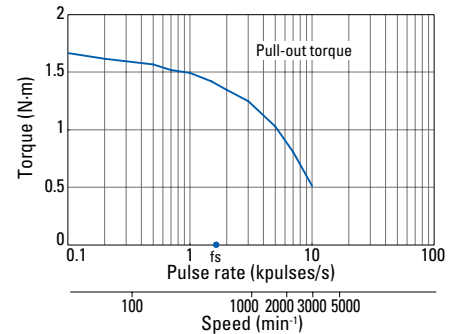

Constant current circuit
Input voltage: 100 VAC
Winding current: 3 A/phase, At 2-phase excitation (full step)
Pull-out torque: $J_L=7.4 \times 10^{-4} \text{kg}\cdot\text{m}^2$ (with rubber coupling used)
fs: Maximum starting pulse rate with no load

Dimensions Unit: mm

56 mm sq.

Cable type

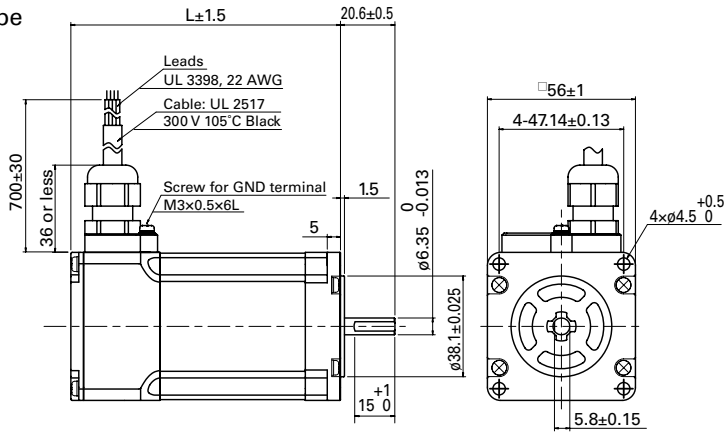

Connector type

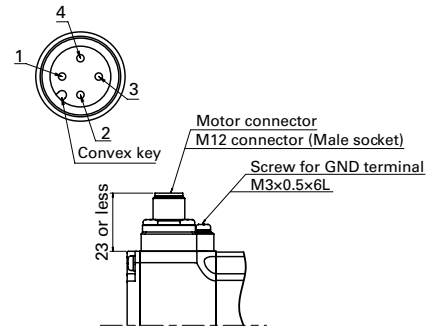

Model no.		Motor length (L)
Cable type	Connector type	
SP2563-5 □ 60	SP2563-5 □ 00	80
SP2566-5 □ 60	SP2566-5 □ 00	102

Compatible drivers

- For motors SP256 □ -52 □ 0 (3 A/phase) or SP256 □ -50 □ 0 (1 A/phase)...
A driver is to be provided by the customer.
- For motors SP256 □ -51 □ 0 (2 A/phase)...
Model no.: BS1D200P10 (DC input)
Operating current selection switch setting: 0

Note: The characteristics shown above are calculated using our experimental circuit.

86 mm sq.

1.8°/step RoHS

Bipolar



Custom options

Custom shaft

Note: Customization feasibility depends on the model number and quantity. Contact us for details.

Model no.		Holding torque at 2-phase excitation N·m or more	Rated current A/phase	Winding resistance		Winding inductance mH/phase	Rotor inertia $\times 10^{-4}$ kg·m ²	Mass kg	Allowable thrust load N	Allowable radial load N
Cable type	Connector type			Cable type	Connector type					
SP2861-5060	SP2861-5000	3.3	2	2.1	2.05	15	1.48	1.95	60	200
SP2861-5160	SP2861-5100	3.3	4	0.61	0.56	3.7	1.48	1.95	60	200
SP2861-5260	–	3.3	6	0.36	–	1.7	1.48	1.95	60	200
SP2862-5060	SP2862-5000	6.4	2	3.2	3.2	25	3	3.1	60	200
SP2862-5160	SP2862-5100	6.4	4	0.85	0.83	6.4	3	3.1	60	200
SP2862-5260	–	6.4	6	0.41	–	2.8	3	3.1	60	200
SP2863-5060	SP2863-5000	9	2	4	4	32	4.5	4.2	60	200
SP2863-5160	SP2863-5100	9	4	1.05	1	7.9	4.5	4.2	60	200
SP2863-5260	–	9	6	0.53	–	3.8	4.5	4.2	60	200

- Models with a brake, encoder, or oil seal have different model nos., rotor inertia, and mass.
- Connector-type models are available for 4 A or lower rated voltages.

Characteristics

SP2861-5000
SP2861-5060

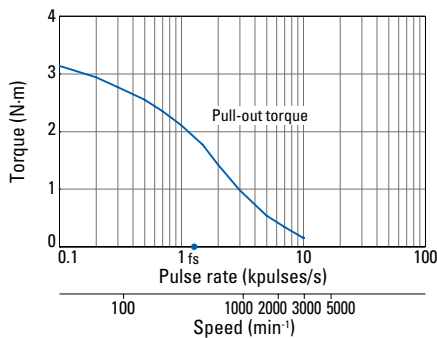

Constant current circuit
Input voltage: 100 VAC,
Winding current: 2 A/phase, At 2-phase excitation (full step)
Pull-out torque: $J_L=15.3 \times 10^{-4}$ kg·m² (with rubber coupling used)
 f_s : Maximum starting pulse rate with no load

SP2861-5100
SP2861-5160

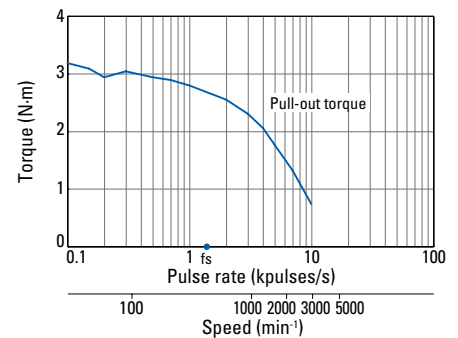

Constant current circuit
Input voltage: 100 VAC,
Winding current: 4 A/phase, At 2-phase excitation (full step)
Pull-out torque: $J_L=15.3 \times 10^{-4}$ kg·m² (with rubber coupling used)
 f_s : Maximum starting pulse rate with no load

SP2861-5260

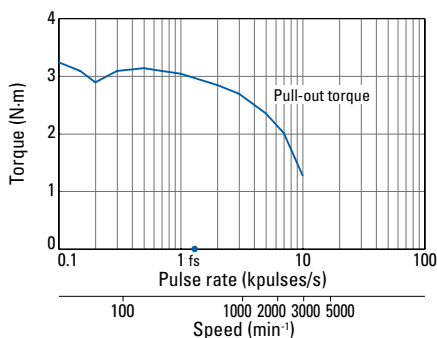

Constant current circuit
Input voltage: 100 VAC
Winding current: 6 A/phase, At 2-phase excitation (full step)
Pull-out torque: $J_L=15.3 \times 10^{-4}$ kg·m² (with rubber coupling used)
 f_s : Maximum starting pulse rate with no load

SP2862-5000
SP2862-5060

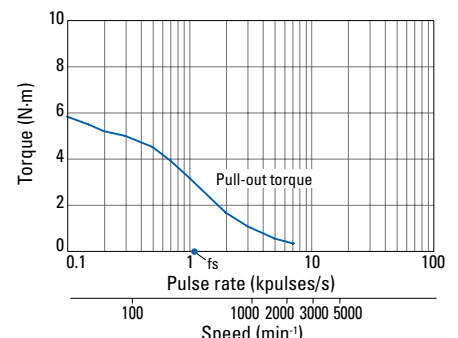

Constant current circuit
Input voltage: 100 VAC
Winding current: 2 A/phase, At 2-phase excitation (full step)
Pull-out torque: $J_L=15.3 \times 10^{-4}$ kg·m² (with rubber coupling used)
 f_s : Maximum starting pulse rate with no load

SP2862-5100
SP2862-5160

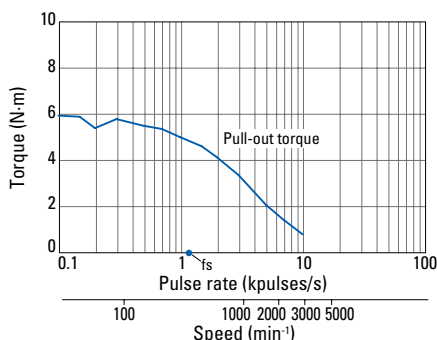

Constant current circuit
Input voltage: 100 VAC,
Winding current: 4 A/phase, At 2-phase excitation (full step)
Pull-out torque: $J_L=15.3 \times 10^{-4}$ kg·m² (with rubber coupling used)
 f_s : Maximum starting pulse rate with no load

SP2862-5260

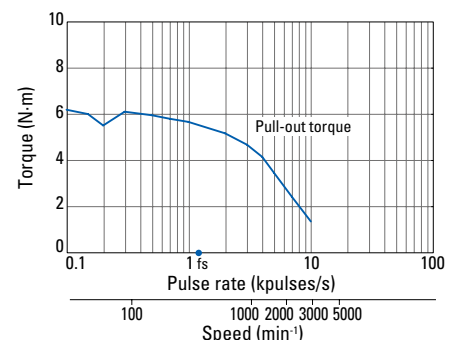

Constant current circuit
Input voltage: 100 VAC
Winding current: 6 A/phase, At 2-phase excitation (full step)
Pull-out torque: $J_L=15.3 \times 10^{-4}$ kg·m² (with rubber coupling used)
 f_s : Maximum starting pulse rate with no load

Characteristics

SP2863-5000
SP2863-5060

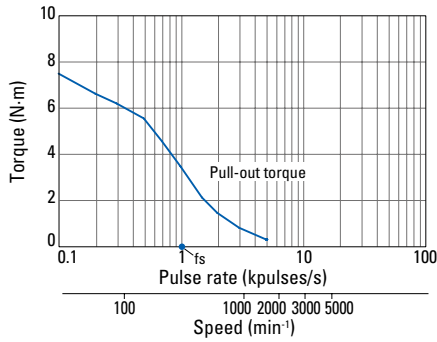

Constant current circuit
Input voltage: 100 VAC
Winding current: 2 A/phase, At 2-phase excitation (full step)
Pull-out torque: $J_s=44 \times 10^{-4} \text{kg}\cdot\text{m}^2$ (with rubber coupling used)
fs: Maximum starting pulse rate with no load

SP2863-5100
SP2863-5160

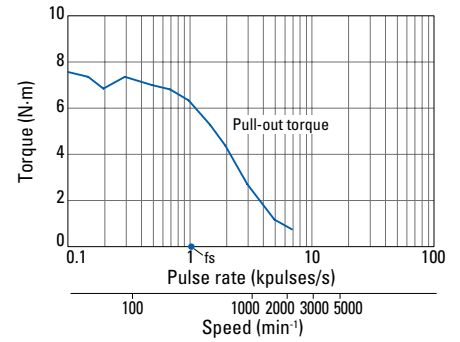

Constant current circuit
Input voltage: 100 VAC
Winding current: 4 A/phase, At 2-phase excitation (full step)
Pull-out torque: $J_s=44 \times 10^{-4} \text{kg}\cdot\text{m}^2$ (with rubber coupling used)
fs: Maximum starting pulse rate with no load

SP2863-5260

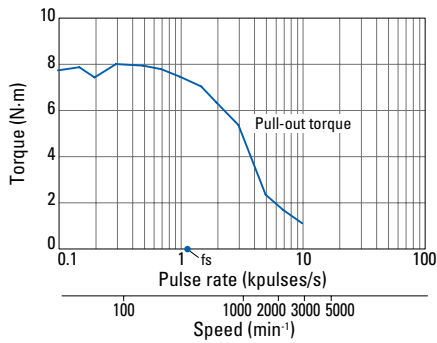

Constant current circuit
Input voltage: 100 VAC
Winding current: 6 A/phase, At 2-phase excitation (full step)
Pull-out torque: $J_s=44 \times 10^{-4} \text{kg}\cdot\text{m}^2$ (with rubber coupling used)
fs: Maximum starting pulse rate with no load

Dimensions Unit: mm

86 mm sq.

Cable type

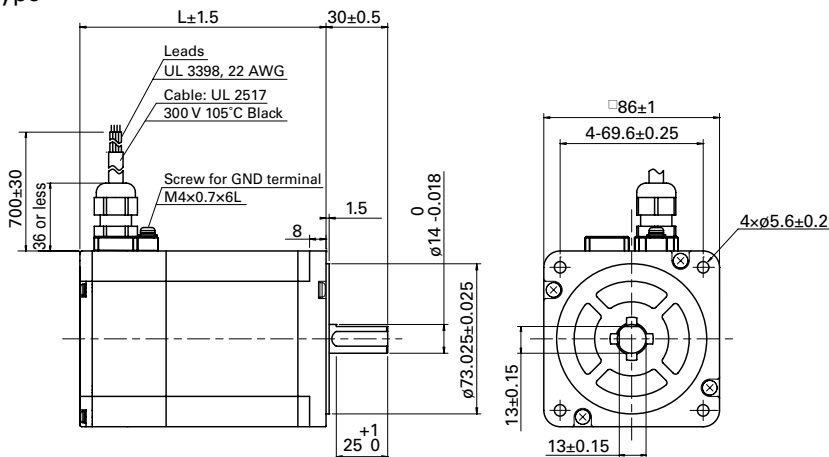

Connector type

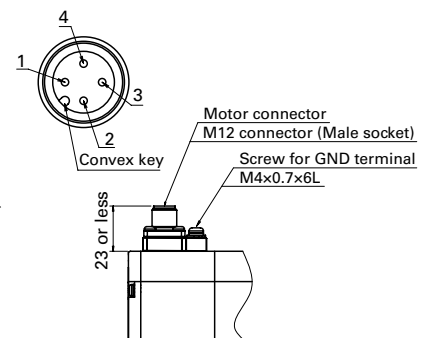

Model no.	Motor length (L)
SP2861-5 □ 60	89.5
SP2862-5 □ 60	120
SP2863-5 □ 60	150

Compatible drivers

A driver is to be provided by the customer.

Note: The characteristics shown above are calculated using our experimental circuit.

In-Vacuum Stepping Motors

Custom product

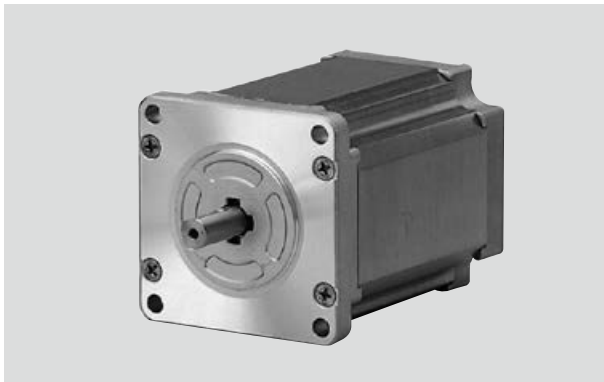

Features

- These can be driven in vacuum environments without requiring a vacuum feedthrough. These stepping motors can be used as an actuator suitable for vacuum environments while maintaining the feature of a stepping motor—easy high-precision open-loop control.
- We also offer customization for use in a wide range of pressure environments from low vacuum to ultra-high vacuum.
- Baking at 200°C is possible.
- No significant size change from regular stepping motors.

Operable pressure environments

Low vacuum	Medium vacuum	High vacuum	Ultra-high vacuum
10^5	10^4	10^3	10^2
10^1	1	10^{-1}	10^{-2}
10^{-3}	10^{-4}	10^{-5}	10^{-6}
10^{-7}	10^{-8}		

[Pa]

Applications

Ideal for the following applications. Contact us to discuss your particular application environment needs.

- Semiconductor manufacturing equipment
- Satellite robots
- Electron microscopes
- Large-scale research facilities such as accelerators, synchrotron radiation analysis equipment, etc.

Motor size

42 mm sq. to ϕ 106 mm

Synchronous Motors

Custom product

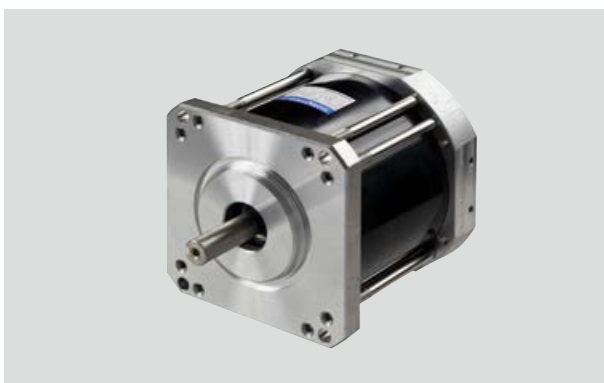

Features

- Synchronous motors rotate at a constant speed in proportion to the AC power frequency without been affected by voltage or load level variations, preventing motor step-out.
- These motors can drive at ultra-low speeds with high torque without using gears.
- Since an AC power supply can be directly connected to the motor, a drive circuit is not required, simplifying your system.
- In addition to 2-phase motors, we also offer 3-phase motors, which don't require a phase shifter.
- Certification for safety standards acquired.

Applications

Ideal for the following applications. Contact us to discuss your particular application environment needs.

- Belt conveyors
- Printers
- Cryopumps
- Cryocoolers
- Switching devices

Motor size

56 mm sq. to ϕ 106 mm

Models No Longer Listed and Their Replacement Models

Models no longer listed						Replacement models						
56 mm sq. unipolar, lead type						56 mm sq. unipolar, connector type Contact us for lead-type motors.						
Model no.		Holding torque at 2-phase excitation	Rated current	Mass	Motor length (L)	Model no.		Holding torque at 2-phase excitation	Rated current	Mass	Motor length (L)	Page
Single shaft	Dual shaft					Single shaft	Dual shaft					
N-m or more	A/phase	kg	mm	N-m or more	A/phase	kg	mm					
103H7121-0140	103H7121-0110	0.39	1	0.47	41.8	SM2561C10U41	SM2561C10U11	0.53	1	0.49	41.8	p. 50
103H7121-0440	103H7121-0410	0.39	2	0.47	41.8	SM2561C20U41	SM2561C20U11	0.53	2	0.49	41.8	p. 50
103H7121-0740	103H7121-0710	0.39	3	0.47	41.8	SM2561C30U41	SM2561C30U11	0.53	3	0.49	41.8	p. 50
103H7123-0140	103H7123-0110	0.83	1	0.65	53.8	SM2562C10U41	SM2562C10U11	1.1	1	0.69	53.8	p. 50
103H7123-0440	103H7123-0410	0.83	2	0.65	53.8	SM2562C20U41	SM2562C20U11	1.1	2	0.69	53.8	p. 50
103H7123-0740	103H7123-0710	0.78	3	0.65	53.8	SM2562C30U41	SM2562C30U11	1.1	3	0.69	53.8	p. 50
103H7124-0140	103H7124-0110	0.98	1	0.8	63.8	SM2562C10U41	SM2562C10U11	1.1	1	0.69	53.8	p. 50
103H7124-0440	103H7124-0410	0.98	2	0.8	63.8	SM2562C20U41	SM2562C20U11	1.1	2	0.69	53.8	p. 50
103H7124-0740	103H7124-0710	0.98	3	0.8	63.8	SM2562C30U41	SM2562C30U11	1.1	3	0.69	53.8	p. 50
103H7126-0140	103H7126-0110	1.27	1	0.98	75.8	SM2563C10U41	SM2563C10U11	1.7	1	1.1	75.8	p. 50
103H7126-0440	103H7126-0410	1.27	2	0.98	75.8	SM2563C20U41	SM2563C20U11	1.7	2	1.1	75.8	p. 50
103H7126-0740	103H7126-0710	1.27	3	0.98	75.8	SM2563C30U41	SM2563C30U11	1.7	3	1.1	75.8	p. 50
56 mm sq. bipolar, lead type						56 mm sq. bipolar, connector type Contact us for lead-type motors.						
Model no.		Holding torque at 2-phase excitation	Rated current	Mass	Motor length (L)	Model no.		Holding torque at 2-phase excitation	Rated current	Mass	Motor length (L)	Page
Single shaft	Dual shaft					Single shaft	Dual shaft					
N-m or more	A/phase	kg	mm	N-m or more	A/phase	kg	mm					
103H7121-5640	103H7121-5610	0.55	1	0.47	41.8	SM2561C10B41	SM2561C10B11	0.75	1	0.49	41.8	p. 52
103H7121-5740	103H7121-5710	0.55	2	0.47	41.8	SM2561C20B41	SM2561C20B11	0.75	2	0.49	41.8	p. 52
103H7121-5840	103H7121-5810	0.55	3	0.47	41.8	SM2561C30B41	SM2561C30B11	0.75	3	0.49	41.8	p. 52
103H7123-5640	103H7123-5610	1.0	1	0.65	53.8	SM2562C10B41	SM2562C10B11	1.4	1	0.69	53.8	p. 52
103H7123-5740	103H7123-5710	1.0	2	0.65	53.8	SM2562C20B41	SM2562C20B11	1.4	2	0.69	53.8	p. 52
103H7123-5840	103H7123-5810	1.0	3	0.65	53.8	SM2562C30B41	SM2562C30B11	1.4	3	0.69	53.8	p. 52
103H7126-5640	103H7126-5610	1.6	1	0.98	75.8	SM2563C10B41	SM2563C10B11	2.35	1	1.1	75.8	p. 52
103H7126-5740	103H7126-5710	1.6	2	0.98	75.8	SM2563C20B41	SM2563C20B11	2.35	2	1.1	75.8	p. 52
103H7126-5840	103H7126-5810	1.6	3	0.98	75.8	SM2563C30B41	SM2563C30B11	2.35	3	1.1	75.8	p. 52
103H7128-5640	103H7128-5610	2.0	1	1.3	94.8	SM2563C10B41	SM2563C10B11	2.35	1	1.1	75.8	p. 52
103H7128-5740	103H7128-5710	2.0	2	1.3	94.8	SM2563C20B41	SM2563C20B11	2.35	2	1.1	75.8	p. 52
103H7128-5840	103H7128-5810	2.0	3	1.3	94.8	SM2563C30B41	SM2563C30B11	2.35	3	1.1	75.8	p. 52

Replacement of 56 and 60 mm sq. motors

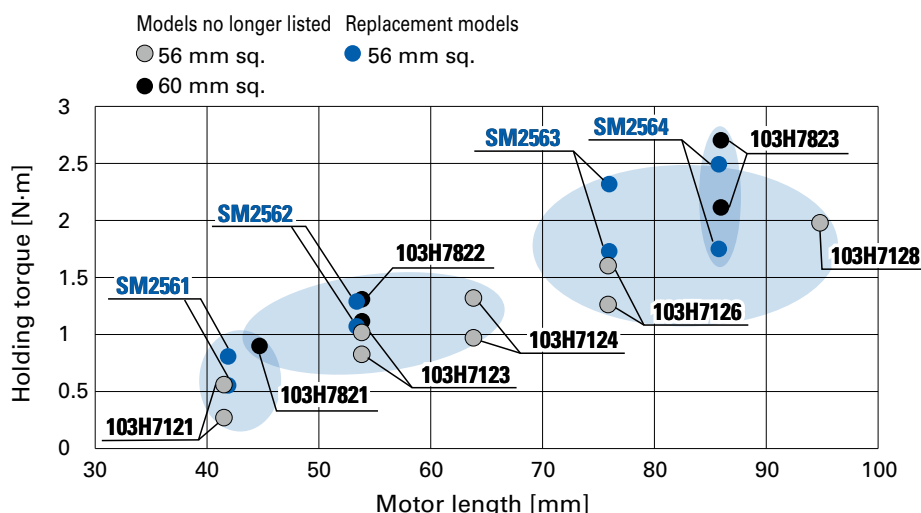

Models no longer listed						Replacement models						
60 mm sq. unipolar, connector type						56 mm sq. unipolar, connector type						
Model no.		Holding torque at 2-phase excitation	Rated current	Mass	Motor length (L)	Model no.		Holding torque at 2-phase excitation	Rated current	Mass	Motor length (L)	Page
Single shaft	Dual shaft	N-m or more	A/phase	kg	mm	Single shaft	Dual shaft	N-m or more	A/phase	kg	mm	
103H7821-0140	103H7821-0110	0.78	1	0.6	44.8	SM2561C10U41	SM2561C10U11	0.53	1	0.49	41.8	p. 50
103H7821-0440	103H7821-0410	0.78	2	0.6	44.8	SM2561C20U41	SM2561C20U11	0.53	2	0.49	41.8	p. 50
103H7821-0740	103H7821-0710	0.78	3	0.6	44.8	SM2561C30U41	SM2561C30U11	0.53	3	0.49	41.8	p. 50
103H7822-0140	103H7822-0110	1.17	1	0.77	53.8	SM2562C10U41	SM2562C10U11	1.1	1	0.69	53.8	p. 50
103H7822-0440	103H7822-0410	1.17	2	0.77	53.8	SM2562C20U41	SM2562C20U11	1.1	2	0.69	53.8	p. 50
103H7822-0740	103H7822-0710	1.17	3	0.77	53.8	SM2562C30U41	SM2562C30U11	1.1	3	0.69	53.8	p. 50
103H7823-0140	103H7823-0110	2.1	1	1.34	85.8	SM2564C10U41	SM2564C10U11	1.75	1	1.27	85.8	p. 50
103H7823-0440	103H7823-0410	2.1	2	1.34	85.8	SM2564C20U41	SM2564C20U11	1.75	2	1.27	85.8	p. 50
103H7823-0740	103H7823-0710	2.1	3	1.34	85.8	SM2564C30U41	SM2564C30U11	1.75	3	1.27	85.8	p. 50
60 mm sq. unipolar, lead type NEMA 23 mounting compatible (47.14 mm)						56 mm sq. unipolar, connector type Contact us for lead-type motors.						
Model no.		Holding torque at 2-phase excitation	Rated current	Mass	Motor length (L)	Model no.		Holding torque at 2-phase excitation	Rated current	Mass	Motor length (L)	Page
Single shaft	Dual shaft	N-m or more	A/phase	kg	mm	Single shaft	Dual shaft	N-m or more	A/phase	kg	mm	
103H7821-0160	103H7821-0130	0.78	1	0.6	43.5	SM2561C10U41	SM2561C10U11	0.53	1	0.49	41.8	p. 50
103H7821-0460	103H7821-0430	0.78	2	0.6	43.5	SM2561C20U41	SM2561C20U11	0.53	2	0.49	41.8	p. 50
103H7821-0760	103H7821-0730	0.78	3	0.6	43.5	SM2561C30U41	SM2561C30U11	0.53	3	0.49	41.8	p. 50
103H7822-0160	103H7822-0130	1.17	1	0.77	52.5	SM2562C10U41	SM2562C10U11	1.1	1	0.69	53.8	p. 50
103H7822-0460	103H7822-0430	1.17	2	0.77	52.5	SM2562C20U41	SM2562C20U11	1.1	2	0.69	53.8	p. 50
103H7822-0760	103H7822-0730	1.17	3	0.77	52.5	SM2562C30U41	SM2562C30U11	1.1	3	0.69	53.8	p. 50
103H7823-0160	103H7823-0130	2.1	1	1.34	84.5	SM2564C10U41	SM2564C10U11	1.75	1	1.27	85.8	p. 50
103H7823-0460	103H7823-0430	2.1	2	1.34	84.5	SM2564C20U41	SM2564C20U11	1.75	2	1.27	85.8	p. 50
103H7823-0760	103H7823-0730	2.1	3	1.34	84.5	SM2564C30U41	SM2564C30U11	1.75	3	1.27	85.8	p. 50
60 mm sq. bipolar, connector type						56 mm sq. bipolar, connector type						
Model no.		Holding torque at 2-phase excitation	Rated current	Mass	Motor length (L)	Model no.		Holding torque at 2-phase excitation	Rated current	Mass	Motor length (L)	Page
Single shaft	Dual shaft	N-m or more	A/phase	kg	mm	Single shaft	Dual shaft	N-m or more	A/phase	kg	mm	
103H7821-5740	103H7821-5710	0.88	2	0.6	44.8	SM2561C20B41	SM2561C20B11	0.75	2	0.49	41.8	p. 52
103H7821-1740	103H7821-1710	0.88	4	0.6	44.8	SM2561C40B41	SM2561C40B11	0.75	4	0.49	41.8	p. 52
103H7822-5740	103H7822-5710	1.37	2	0.77	53.8	SM2562C20B41	SM2562C20B11	1.4	2	0.69	53.8	p. 52
103H7822-1740	103H7822-1710	1.37	4	0.77	53.8	SM2562C40B41	SM2562C40B11	1.4	4	0.69	53.8	p. 52
103H7823-5740	103H7823-5710	2.7	2	1.34	85.8	SM2564C20B41	SM2564C20B11	2.5	2	1.27	85.8	p. 52
103H7823-1740	103H7823-1710	2.7	4	1.34	85.8	SM2564C40B41	SM2564C40B11	2.5	4	1.27	85.8	p. 52
60 mm sq. bipolar, lead type NEMA 23 mounting compatible (47.14 mm)						56 mm sq. bipolar, connector type Contact us for lead-type motors.						
Model no.		Holding torque at 2-phase excitation	Rated current	Mass	Motor length (L)	Model no.		Holding torque at 2-phase excitation	Rated current	Mass	Motor length (L)	Page
Single shaft	Dual shaft	N-m or more	A/phase	kg	mm	Single shaft	Dual shaft	N-m or more	A/phase	kg	mm	
103H7821-5760	103H7821-5730	0.88	2	0.6	43.5	SM2561C20B41	SM2561C20B11	0.75	2	0.49	41.8	p. 52
103H7821-1760	103H7821-1730	0.88	4	0.6	43.5	SM2561C40B41	SM2561C40B11	0.75	4	0.49	41.8	p. 52
103H7822-5760	103H7822-5730	1.37	2	0.77	52.5	SM2562C20B41	SM2562C20B11	1.4	2	0.69	53.8	p. 52
103H7822-1760	103H7822-1730	1.37	4	0.77	52.5	SM2562C40B41	SM2562C40B11	1.4	4	0.69	53.8	p. 52
103H7823-5760	103H7823-5730	2.7	2	1.34	84.5	SM2564C20B41	SM2564C20B11	2.5	2	1.27	85.8	p. 52
103H7823-1760	103H7823-1730	2.7	4	1.34	84.5	SM2564C40B41	SM2564C40B11	2.5	4	1.27	85.8	p. 52
ø86 mm bipolar, lead type						86 mm sq. bipolar, lead type						
Model no.		Holding torque at 2-phase excitation	Rated current	Mass	Motor length (L)	Model no.		Holding torque at 2-phase excitation	Rated current	Mass	Motor length (L)	Page
Single shaft	Dual shaft	N-m or more	A/phase	kg	mm	Single shaft	Dual shaft	N-m or more	A/phase	kg	mm	
103H8221-6240	103H8221-6210	2.74	6	1.5	62	SM2861-5251	SM2861-5221	3.3	6	1.75	66	p. 66
103H8222-6340	103H8222-6310	5.09	6	2.5	92.2	SM2862-5251	SM2862-5221	6.4	6	2.9	96.5	p. 66
103H8223-6340	103H8223-6310	7.44	6	3.5	125.9	SM2863-5251	SM2863-5221	9	6	4.0	127	p. 66

Safety Precautions

The products in this catalog are designed to be used with general industrial equipment. When using them, pay sufficient attention to the following points.

- Read the included Instruction Manual carefully before installing, assembling, and using the product for proper use.
- Do not modify or alter the product in any way.
- Contact us or your point of sale for installation or maintenance services of the product.
- Consult us when using the product for the following uses, as these require special considerations for operations, maintenance, and management such as redundancy and emergency power generators.
 - ❶ Use in medical equipment that may have an effect on human life or the human body
 - ❷ Use in transportation systems or transport-related equipment such as trains or elevators that may have an effect on human life or the human body
 - ❸ Use in computer systems that may have an impact on society or on the public
 - ❹ Use in other devices that have a major impact on human safety or on maintaining public operations
- In addition to the above, contact us or your point of sale for use in an environment where vibrations occur, such as in automobiles or transportation.
- For use in space, aviation, or nuclear power-related applications, contact us or your point of sale.
- The products listed in this catalog fall into the category 16 of Appended Table 1 of the Export Trade Control Order. To export these products as an individual part or to export a device into which they are assembled, the "Inform Requirements" and "Objective Requirements"—established by the Ministry of Economy, Trade and Industry of Japan based on the "Catch-all Controls"—must be studied for applicability. Accordingly, appropriate export formalities must be performed.

Safety Precautions

Warning Labels on Products

Either or all of the following symbols are labeled on products depending on the model of driver or stepping motor.



This label is attached in the vicinity of high-voltage portions such as charging or cover-protected parts, to indicate locations with risk of electric shock.



This label is attached in the vicinity of the grounding terminals of drivers to indicate that grounding is required.



This label is attached to the portion of drivers where a voltage of 42.4 VAC or 60 VDC or more is applied, drawing attention to the risk of electric shock.



Indicates that the stepping motor may get hot, resulting in burns.



Indicates that the stepping motor should be grounded.

Safety Alert Symbols

The following safety symbols are used in the manual to indicate different hazardous situations and prohibited/required actions.

DANGER Indicates hazards that could cause severe bodily injury or death as a result of failure to follow the instructions.

CAUTION Indicates possible hazards that could cause moderate bodily injury or only property damage as a result of failure to follow the instructions.

Note that even items with a symbol could potentially lead to serious outcomes, depending on the situation. They all indicate important situations, so be sure to observe them.

PROHIBITED Indicates actions that must not be taken.

COMPULSORY Indicates actions that must be taken.

DANGER

General

1. Do not use the product in an explosive, flammable or corrosive atmosphere, watery place or near a combustible material. Failure to follow this may cause injury or fire.
2. Only technically qualified personnel should transport, install, wire, operate, or perform maintenance and inspection on the product. Failure to follow this may cause electric shock, injury, or fire.
3. Do not work on wiring, maintenance servicing, or inspection with power on. Perform either of those five minutes after turning the power off. Failure to follow this may cause electrical shock.
4. When the protective functions of the product is activated, turn the power off immediately and eliminate the cause. If continuing the operation without eliminating the cause, the product may operate improperly and cause injury or a breakdown of the system devices.
5. Stepping motor may run out of order when operating and stopping depending on the magnitude of the load. Put the product into use after sufficient trial test operation in the maximum planned load conditions to check that the product can handle the load. Doing otherwise may cause a breakdown of the system. (Should the product run out of order in the use to drive upward/downward, it may cause a fall of the load.)
6. Do not touch the internal parts of the driver. Failure to follow this may cause electrical shock.

Wiring

7. Do not connect the stepping motor directly to a mains outlet. Failure to follow this may cause electric shock, injury, or fire. Stepping motors should be powered by stepping drivers (except for synchronous motors).
8. Use an input voltage within the rated voltage range. Using otherwise may cause fire or an electric shock.
9. Connect the driver and stepping motor to the ground. Failure to follow this may cause electrical shock.
10. Do not damage, apply excessive stresses, put heavy things on, or tuck down cables. Failure to follow this may cause electrical shock.
11. Perform wiring with the power cable as instructed by the wiring diagram or the Instruction Manual. Failure to follow this may cause electric shock or fire.
12. Our stepping motor cables are for fixed-wiring use, so do not use products in applications where flex cables are required. Failure to follow this may cause electric shock, injury, or fire.

Operation

13. Be sure not to touch the rotating part of the stepping motor during its operation. Failure to do so may cause injury.
14. Do not reach or touch the electric terminals while electric power is on. Failure to follow this may cause electrical shock.
15. Never disconnect any of the connectors while electric power is on. Failure to follow this may cause electric shock or product damage.
16. Do not operate products with live parts exposed. Failure to follow this may cause electrical shock.
17. If smoke, fire, unusual smells, or unusual sounds are produced from the driver or stepping motor, turn off the power and stop using them immediately. Failure to follow this may cause electric shock, injury, or fire.

CAUTION

General

1. Prior to installation, operation, maintenance servicing or inspection, be sure to read the Instruction Manual and follow the instructions. Failure to follow this may cause electric shock, injury, or fire.
2. Do not use the driver or the stepping motor in conditions that exceed the specification values. Failure to follow this may cause electric shock, injury, or fire.
3. Do not insert a finger or an object into the opening of products. Failure to follow this may cause electric shock, injury, or fire.
4. Do not use a damaged driver or stepping motor. Doing so may cause injury or fire.

5. Use the driver and stepping motor in the designated combination. Failure to follow this may cause fire or product failures.
6. The driver, motor, and peripheral devices become hot during operation, so use them carefully. Otherwise it may result in a burn.
7. Never disassemble, repair, modify, or alter products. Failure to follow this may cause electric shock, injury, or fire.
8. Do not remove the product name plate. Using products with incorrect ratings may result in fire.
9. Be careful that this product does not fall or tip over when handling, as this can be dangerous.

Unpacking

10. Unpack the box right side up. Failure to do so may result in injury.
11. Confirm that the product you received is the one that you have ordered. Installing an incorrect product may cause a breakdown.

Wiring

12. Do not perform measurements of insulation resistance or dielectric strength. Failure to follow this may cause product damage. Contact us or your point of sale instead, if such a measurement is required.
13. Perform wiring work according to local standards of electrical installations. Failure to follow this may cause motor burnout or fire.
14. Perform wiring correctly and securely. Incorrect wiring may cause the stepping motor to run out of control, resulting in injury.
15. Insulate the attached condenser and external resistance connection terminals. Failure to follow this may cause electrical shock.

Installation

16. Do not climb or attach a heavy article on the product. Failure to do so may cause injury.
17. Do not obstruct the air intake and exhaust vents. Failure to follow this may cause fire.
18. Make sure to use the specified driver mounting direction. Failure to follow this may cause product failures.
19. Keep a distance as instructed by the Instruction Manual for the driver from the inner surface of the control console or other devices. Failure to follow this may cause product failures.
20. Place the product with great care so as to prevent from danger such as a tumble or a turnover.
21. Install the product to incombustible materials such as metals. Failure to do so may cause fire, injury, or device breakdown.
22. Do not place combustible material around this product. Failure to do so may result in fire or burns.
23. Be sure to provide an adequate ventilation path when installing this product, and do not block the intake and exhaust ports. Failure to do so may result in electric shock, fire, or device breakdown.
24. Confirm the rotating direction before connecting with the mechanical device. Failure to follow this may cause injury or product damage.
25. Do not touch the motor output spindle (including the key slot and gears) with your bare hand. Failure to do so may cause injury.
26. Do not to apply force that exceeds the specified allowable loads to the motor output shaft.

Operation

27. The stepping motor is not equipped with any protective device. Prepare an overvoltage protection device, earth leakage breaker, overheat protection device, and emergency stop device to ensure safe operation. Failure to follow this may cause injury or fire.
28. Do not touch the product for a period after the power is on or has been turned off, since the driver and stepping motor remain at a high temperature. Failure to do so may cause burns. In particular, the temperature rises considerably of the stepping motor depending on the operating conditions. Do not allow the motor surface to exceed the following temperatures:

Thermal class F (+155°C) stepping motors: 125°C

Thermal class B (+130°C) stepping motors: 100°C

Regardless of thermal class, encoder equipped stepping motors: 85°C, in-vacuum stepping motors: 150°C

29. Immediately stop operation in case of anomaly. Failure to do so may cause an electric shock, injury or fire.
30. Do not perform drastic setting changes as such changes may cause unstable operation. Failure to do so may cause injury.

31. During trial operations, firmly stabilize the stepping motor, and confirm operations by disconnecting from the mechanical system before connecting with it. Failure to do so may cause injury.
32. When the alarm has been activated, eliminate the cause and ensure safety before resuming operations. Failure to do so may cause injury.
33. When the electric power recovers after a momentary interruption, do not approach the devices because the system may restart operation by itself. (Set the system so as to secure the safety even when it restarts on such occasions.) Failure to do so may cause injury.
34. Confirm that the electric power supply properly conforms to the product specifications. Failure to follow this may cause product failures.
35. The electromagnetic brake is designed to hold the motor position in place. Do not use it as dynamic braking. Doing so may cause the breakdown of the system.
36. Secure the key when operating the motor with a key. Failure to do so may cause injury.
37. For use in applications where varying loads are applied to the shaft, contact us in advance. Use in environments with varying loads might result in equipment failure.

Maintenance

38. Be careful when performing maintenance services or inspection as the driver and stepping motor frames get hot. Failure to do so may cause burns.
39. It is recommended that the electrolytic condenser of the driver is replaced with a new one as preventive maintenance after using for 5 years (the expected life in an average operating environment of 40°C). The expected life of the fuse is 10 years in an average operating environment of 40°C. Thus, periodical replacement is recommended.
40. Contact us or your point of sale for repair. If the product is disassembled by the user, it may become inoperable.

Transportation

41. Handle the product with care during transportation so as to prevent from dangers such as tumbling or overturning.
42. Do not hold with the cable or the motor shaft when transporting. Failure to follow this may cause product damage or injury.

Disposal

43. Dispose of stepping drivers and motors as industrial waste.

PROHIBITED

Storage

1. Avoid storing products in locations exposed to rain or water drops, or in an environment with hazardous gas or liquid. Failure to follow this may cause failures.

Maintenance

2. Do not disassemble or repair products by yourself. Failure to follow this may cause fire or electric shock.

General

3. Do not remove the product name plate. Using products with incorrect ratings may result in fire.

COMPULSORY

Storage

1. Store the product in a location that is not exposed to sunlight, at a temperature and humidity within the product specifications.
2. If the driver has been stored for a long period (3 years or longer), contact us. The capacitance of electrolytic capacitors can decrease through long-term storage, which may cause malfunctions.

Operation

3. Install an external emergency stop circuit to turn the power off if needed.

4. Operate this product within the specified ambient temperature and humidity.

Transportation

5. Follow the instructions displayed on the package box and avoid excessively stacking boxes.

■ Selection Guide by Mechanism

Typical mechanism examples and required selection criteria are shown below. Provide us with these information when consulting us for selection.

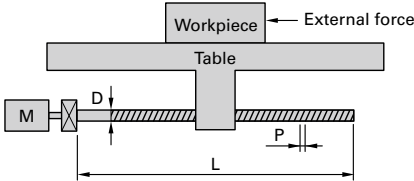
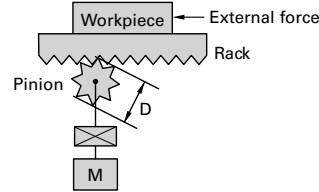
Ball screw			Rack & Pinion				
							
External force	F		N	External force	F		N
Workpiece mass + table mass	W		kg	Workpiece mass + rack mass	W		kg
Ball screw diameter	D		m	Pinion diameter	D		m
Ball screw length	L		m	Pinion thickness	L		m
Ball screw pitch	P		m	Pinion density	ρ		kg/m ³
Ball screw density	ρ		kg/m ³	Friction coefficient	μ		
Friction coefficient	μ			Gear ratio *	G		
Gear ratio *	G			Mechanical efficiency	η		
Mechanical efficiency	η						

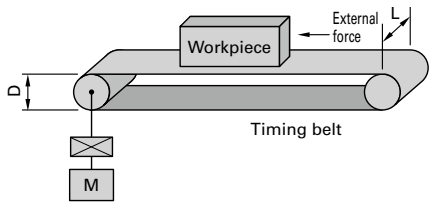
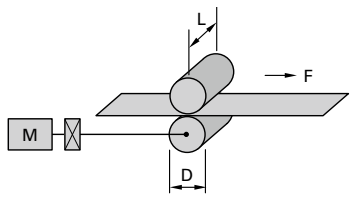
Belt drive			Roll feed				
							
External force	F		N	Sheet tension	F		N
Workpiece mass + belt mass	W		kg	Roll diameter	D		m
Pulley diameter	D		m	Roll width	L		m
Pulley width	L		m	Roll density	ρ		kg/m ³
Pulley density	ρ		kg/m ³	Roll moment of inertia J	J		kg·m ²
Pulley moment of inertia	J		kg·m ²	Gear ratio *	G		
Gear ratio *	G			Mechanical efficiency	η		
Mechanical efficiency	η						

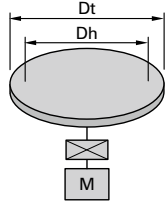
Rotary indexing table			
			
Table mass	W		kg
Table diameter	Dt		m
Table support diameter	Dh		m
Table moment of inertia	J		kg·m ²
Friction coefficient of table support	μ		
Gear ratio *	G		
Mechanical efficiency	η		

* Calculation of gear ratio (G)

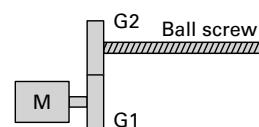

$$G = \frac{\text{Number of screw threads (G2)}}{\text{Number of motor gear teeth (G1)}}$$



■ ECO PRODUCTS

SANYO DENKI's ECO PRODUCTS are designed with the concept of lessening impact on the environment in the process from product development to waste. The product units and packaging materials are designed for reduced environmental impact. We have established our own assessment criteria on the environmental impacts applicable to all processes, ranging from design to manufacture. Those products that satisfy the criteria are accredited as ECO PRODUCTS.

Notes Before Purchase

- Read the accompanying Instruction Manual carefully prior to using the product.
- Do not use this product in an environment where vibration is present, such as in moving vehicles or shipping vessels.
- Do not modify or alter the product in any way.

Please contact us beforehand if you intend to use this product in the following applications.

- Medical equipment that may have an effect on human life
- Systems or equipment that may have a major impact on society or on the public
- Special applications related to aviation and space, nuclear power, electric power, submarine repeaters, etc.