

Diamant P20

IP67 ROTARY ACTUATOR WITH COMPARATO CONNECTION

USE

- systems using alternative energy
- automation systems
- glycol cooling systems
- heating/cooling systems
- open and closed hydraulic systems
- industrial systems using hot and cold fluids
- water treatment systems
- compressed air systems



KEY FEATURES

- ALL IN ONE electric control
- IP67 degree of electrical protection
- auxiliary opening and closing microswitches as standard
- manual override from the top (optional)
- various operating times (optional)

Diamant P20
COMPARATO connection

TECHNICAL FEATURES		Diamant P20				
Electric control	2/3-point, ALL IN ONE					
Connection with ball valve	COMPARATO connection					
Operation	Modulating • ON/OFF					
Rotation	90° • 180°					
Compatible ball valves	2-way • 3-way diverter • 3-way mixer					
Position indicator	Arrow on the drive shaft					
Motor	Bidirectional synchronous					
Power supply	230V 50/60 Hz • 24V 50/60 Hz • 110V 50/60 Hz *					
Electrical connection	Internal terminal block					
Operating times (90°)	4 seconds	12 seconds	35 seconds**	106 seconds	320 seconds	
Nominal torque	5 Nm	11 Nm	11 Nm	11 Nm	11 Nm	
Input power	13 VA		7,5 VA			
Power output of the outlet phase to terminals 4 and 5	1 A, resistive					
Maximum noise (at 1 meter distance)	35 dB(A) standard version					
Additional micro electrical capacity	1 A, resistive					
Heating resistance power	3W					
Operational room temperature	- 10° C ÷ 50° C					
Fluid temperature	See features of ball valves					
Protection degree	IP67					
External covering	Glass-filled "polyarylamide" technopolymer					
Material of external metal components and seals	AISI 303 GVR • Silicone seals					
Maintenance	None					
Certification	CE					

* for the 4-sec and 12-sec versions, the 60Hz version is available on request • ** standard version

VERSIONS

Actuator	Rotation angle	Operating time	Power supply	Base code
	90°	35 sec.	230V 50/60Hz	DY222P2
	90°	35 sec.	110V 50/60Hz	DY212P2
	90°	35 sec.	24V 50/60Hz	DY242P2
	180°	70 sec.	230V 50/60Hz	DY322P2
	180°	70 sec.	110V 50/60Hz	DY312P2
	180°	70 sec.	24V 50/60Hz	DY342P2



Diamant PRO

IP67 ROTARY ACTUATOR WITH COMPARATO CONNECTION

ACCESSORIES

To add any accessory, proceed as per the diagram below, adding one or more letters corresponding to the desired accessory at the end of the Base Code.

STARTING base code

DY222P2

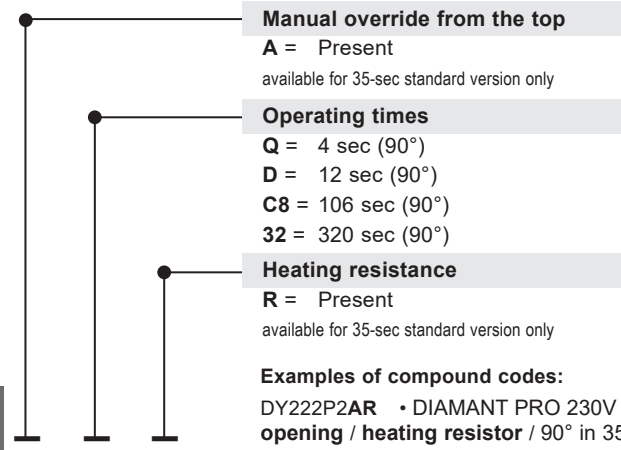

ELECTRICAL CONNECTIONS

With the electrical **ALL IN ONE** control, you can select the **2-POINT** control or the **3-POINT** control by moving the selector (jumper) mounted on the electrical circuit inside the actuator.

2-POINT CONTROL • ON/OFF - One electric control can activate several actuators.

OPENING ACTUATOR

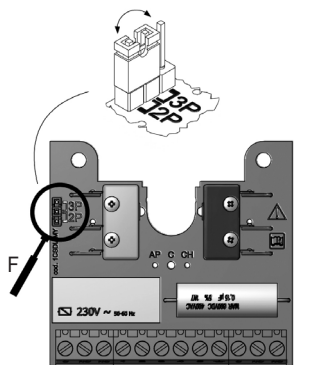
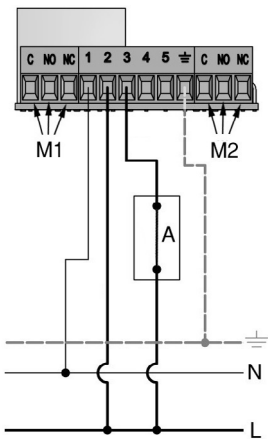

Position the jumper as shown in the picture to have the desired electrical connection

CLOSING ACTUATOR

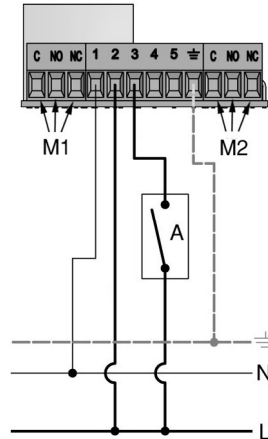

- 1 - Neutral
- 2 - Closing phase
- 3 - Opening phase
- 4 - Outlet opening phase
- 5 - Outlet closing phase
- M1 - Auxiliary micro in opening position
- M2 - Auxiliary micro in closing position
- A - Switch-type control
- ⊕ - Earth

3-POINT CONTROL • ON/OFF - Each actuator must be operated by a single electric control

OPENING ACTUATOR

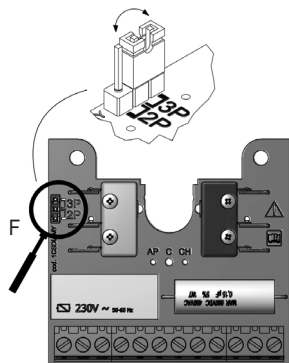
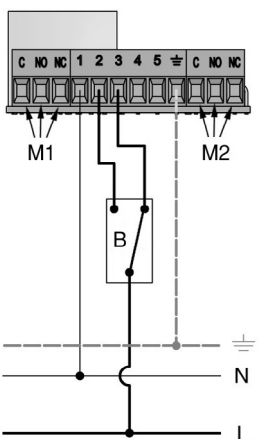

Position the jumper as shown in the picture to have the desired electrical connection

CLOSING ACTUATOR

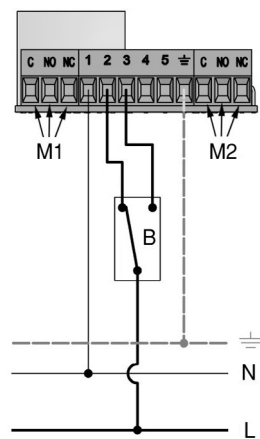

- 1 - Neutral
- 2 - Closing phase
- 3 - Opening phase
- 4 - Outlet opening phase
- 5 - Outlet closing phase
- M1 - Auxiliary micro in opening position
- M2 - Auxiliary micro in closing position
- A - Switch-type control
- ⊕ - Earth

Diamant P20

IP67 ROTARY ACTUATOR WITH COMPARATO CONNECTION

3-POINT CONTROL • MODULATING

Each actuator must be operated by a single electric control

OPENING ACTUATOR

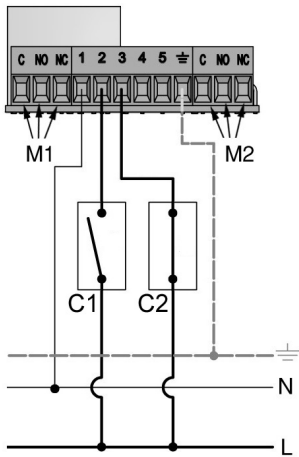

- 1 - Neutral
- 2 - Closing phase
- 3 - Opening phase
- 4 - Outlet opening phase
- 5 - Outlet closing phase
- M1 - Auxiliary micro in opening position
- M2 - Auxiliary micro in closing position
- ⊕ - Earth
- C1 - Closing control
- C2 - Opening control

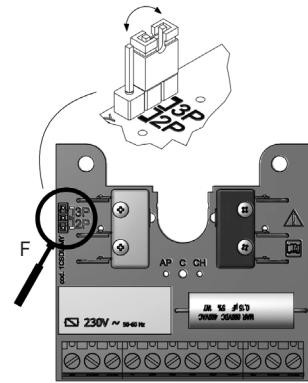

Position the Jumper as shown in the picture to have the desired electrical connection

INTERMEDIATE POSITION

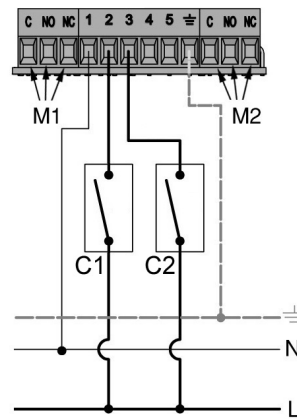

CLOSING ACTUATOR

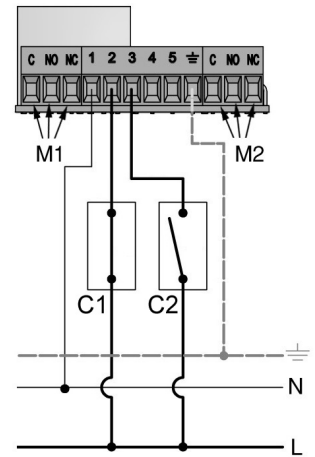

AUXILIARY MICROSWITCHES

The layout of the extra microswitch contacts is shown in the following pictures:

M1 • OPENING AUXILIARY MICROSWITCH

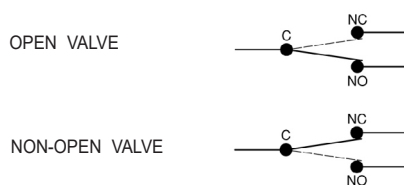

M2 • CLOSING AUXILIARY MICROSWITCH

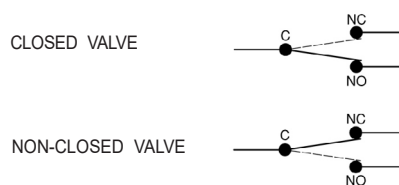

HEATING RESISTANCE

The electrical connection of the internal heater is independent of the positioning control.

The device features faston-type terminals and its voltage is the same as the power supply.

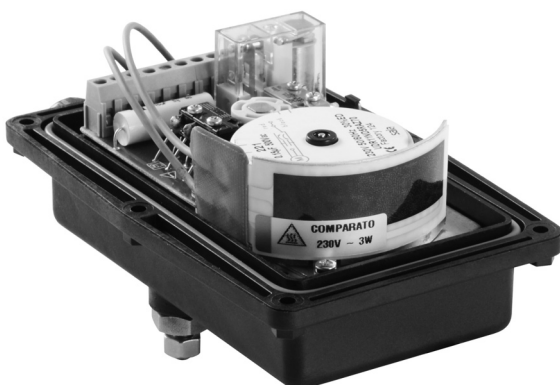

Diamant PRO

IP67 ROTARY ACTUATOR WITH COMPARATO CONNECTION

EXAMPLES OF ELECTRICAL CONNECTIONS

CONNECTION OF THE PUMP STOP WITH TWO 3-POINT ACTUATOR

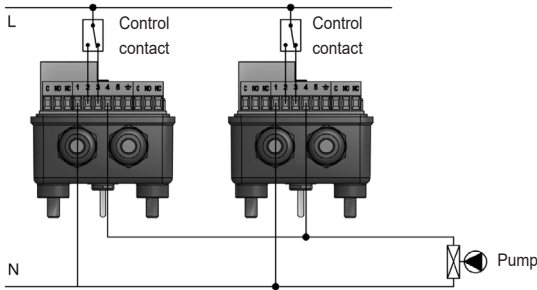

CONNECTION OF THE PUMP STOP WITH TWO 2-POINT ACTUATOR

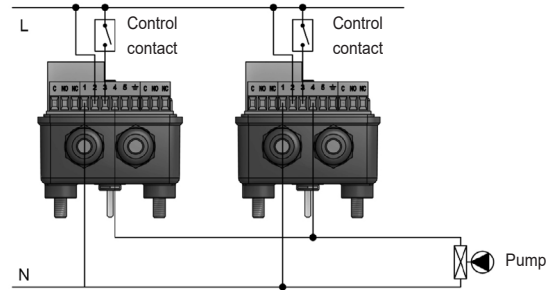

CONNECTION OF THE PUMP STOP WITH A 2-POINT ACTUATOR AND A 3-POINT ACTUATOR

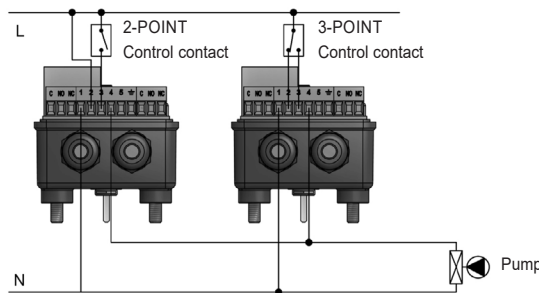

MANUAL OPERATION

Only available for **Diamant PRO** with 35-second operating time. The manual override allows to activate the valve in case of emergency or black-out.

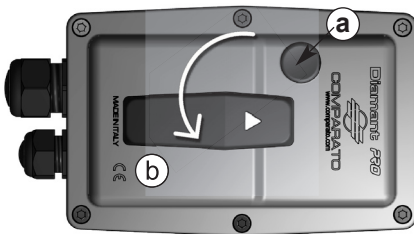

Actuator in **OPENING** position.

Press the release button (a) and, simultaneously, rotate the lever (b) 90° **COUNTERCLOCKWISE**, in order to move the actuator in the **CLOSING** position.

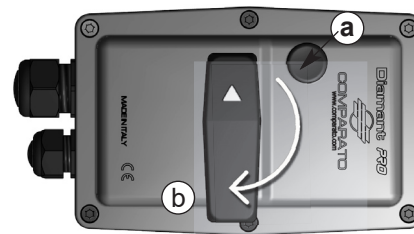

Actuator in **CLOSING** position.

Press the release button (a) and, simultaneously, rotate the lever (b) 90° **CLOCKWISE**, in order to move the actuator in the **OPENING** position.



When you release the plunger, the actuator returns to the control position if it still powered and is able to perform the operation

INSTALLATION

The valve shall not be installed with the actuator's connection facing downwards.

RECOMMENDED POSITION

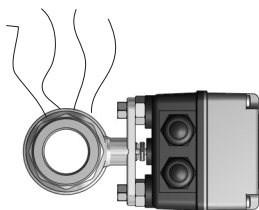

ALLOWED POSITION

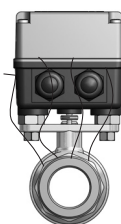

FORBIDDEN POSITION

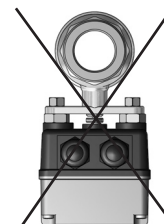

CAUTION! Do not use high-pressure water directly on the actuator (e.g. a pressure washer)



COMPARATO NELLO s.r.l.

UNI EN ISO 9001:2015 CERTIFIED COMPANY

Diamant PRO

IP67 ROTARY ACTUATOR WITH COMPARATO CONNECTION

CONNECTION TO THE BALL VALVE

DIRECT CONNECTION TO THE BALL VALVE

The direct connection of the **Diamant PRO** with **COMPARATO** connection can only be made on the ball valve with **COMPARATO** connection. For the direct coupling to **ISO 5211** connection ball valve see the **PRO Range** data sheet.

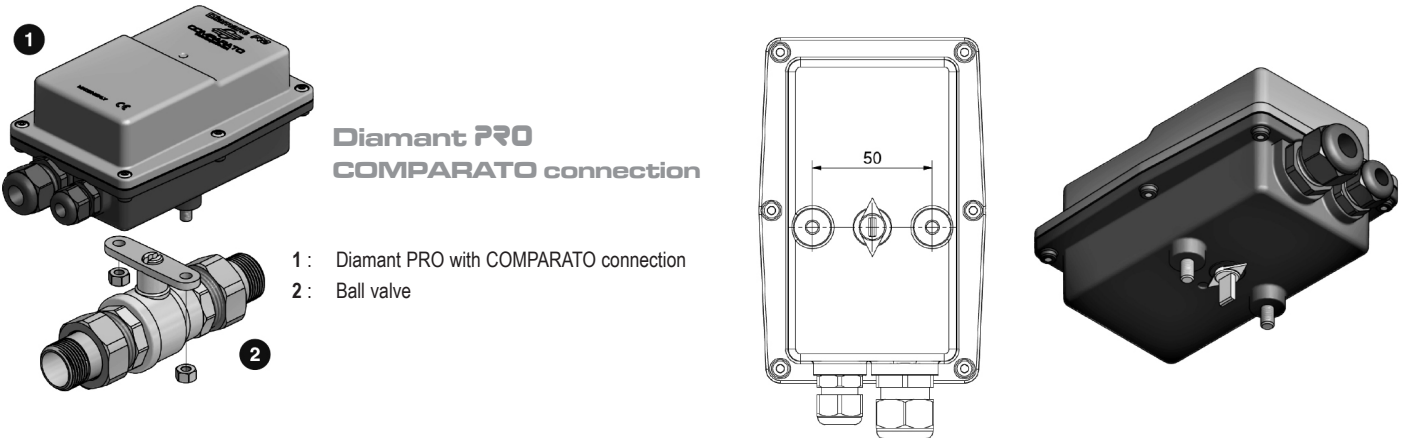

CONNECTION TO THE BALL VALVE WITH A SPACER

The ball valves fitted with a spacer (both with direct rod and manual override) must be motorised with a **Diamant PRO COMPARATO** connection, even if the ball valve has an **ISO 5211** connection.

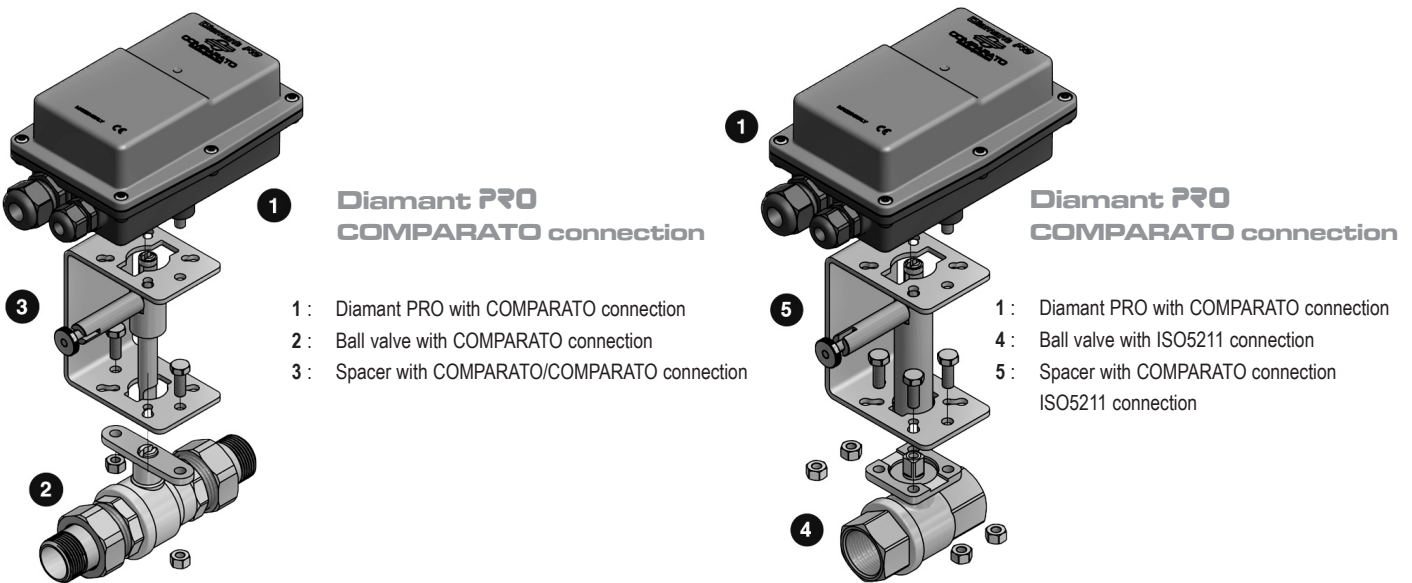

OVERALL SIZE

Diamant PRO
with **COMPARATO** connection

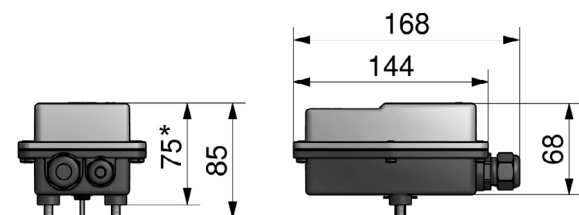

Diamant PRO with **COMPARATO** connection
Version with **MANUAL OVERRIDE FROM THE TOP**

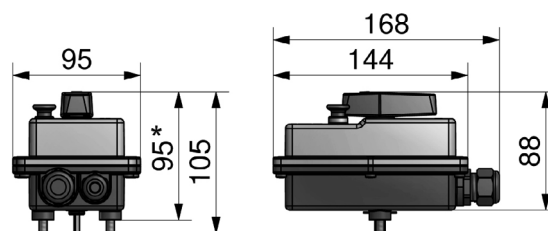

* the size is to be taken into account when coupling the actuator to the ball valve



Diamant *PRO*

IP67 ROTARY ACTUATOR WITH COMPARATO CONNECTION

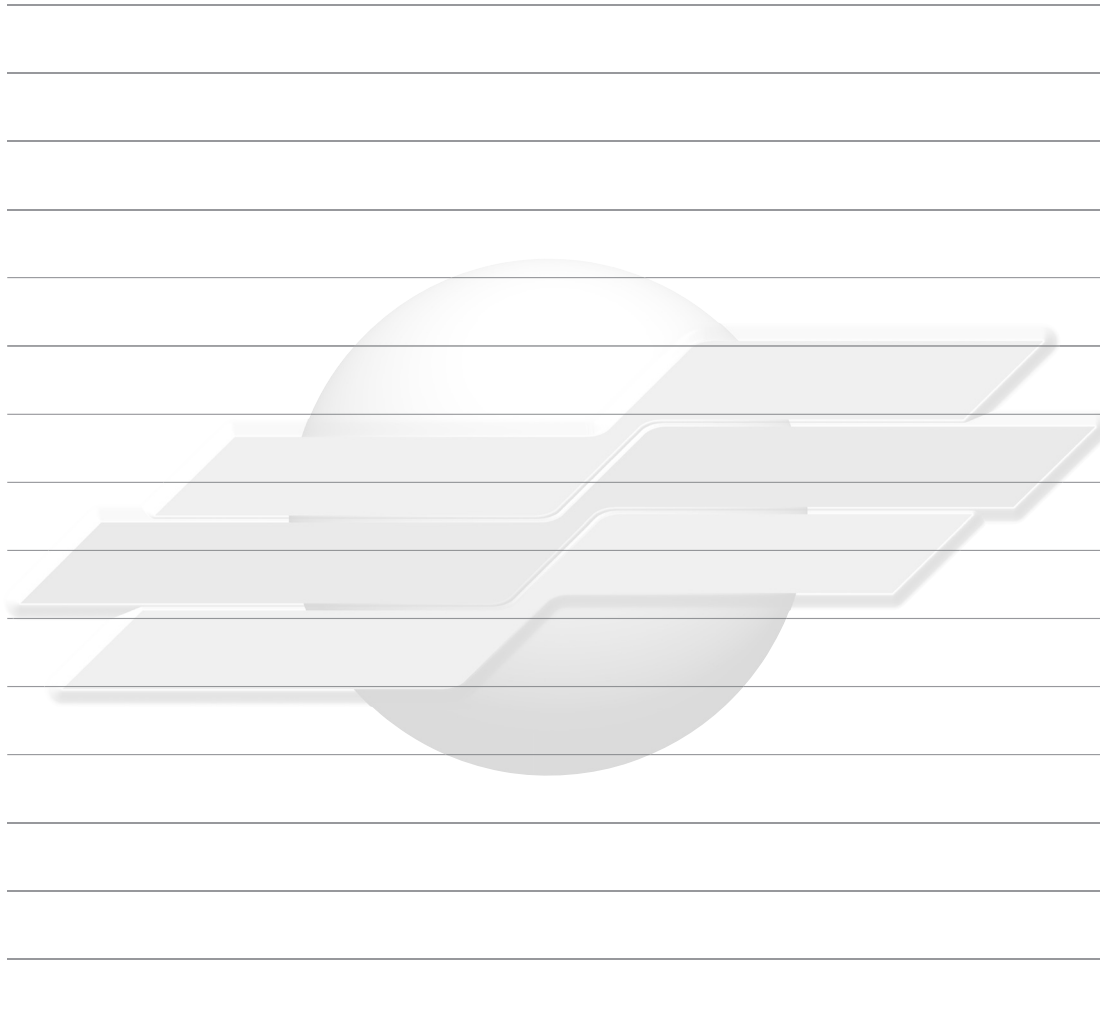

comparato.com

EXAMPLE OF SPECIFICATIONS

DIAMANT PRO ACTUATOR • ALL IN ONE (2-point ON/OFF or 3-point ON/OFF or 3-point modulating), nominal torque: 11 Nm, power supply: 230V - 50/60 Hz, operating times: 35 sec / 90°, operating angle: 90°, degree of protection: IP67, for 2-way, 3-way ball valve, connection to the ball valve: Comparato connection, two auxiliary microswitches.

Brand: **COMPARATO**
Code: **DY222P2**

UPDATED DATA SHEETS AVAILABLE AT www.comparato.com

In order to provide an up-to-date service, Comparato Nello S.r.l. reserves the right to modify technical data, drawings, graphs and photos of this data sheet at any time, without prior notice.

BIM
BUILDING
INFORMATION
MODELING



HYDROTHERMAL SYSTEMS
COMPARATO NELLO s.r.l.
17014 CAIRO MONTENOTTE (SV) ITALIA VIALE DELLA LIBERTÀ • LOCALITÀ FERRANIA • Tel. +39 019 510.371 - FAX +39 019 517.102

www.comparato.com

e-mail: info@comparato.com

UNI EN ISO 9001:2015 CERTIFIED COMPANY