



Free DTM now available  
Contact Pulsar  
for more information

---

# dBi Series ( **HART** ) COMMUNICATION PROTOCOL

## Intelligent Transducer

**Instruction Manual**





**dBi SERIES (HART) (THIRD EDITION REV 4)**

April 2022

Part Number M-560-0-003-4P

***COPYRIGHT***

© Pulsar Measurement, 2012-22. All rights reserved. No part of this publication may be reproduced, transmitted, transcribed, stored in a retrieval system, or translated into any language in any form without the written permission of Pulsar Measurement.

***WARRANTY AND LIABILITY***

Pulsar Measurement guarantee for a period of 2 years from the date of delivery that it will either exchange or repair any part of this product returned to Pulsar Process Measurement Limited if it is found to be defective in material or workmanship, subject to the defect not being due to unfair wear and tear, misuse, modification or alteration, accident, misapplication, or negligence.

***DISCLAIMER***

Pulsar Measurement neither gives nor implies any process guarantee for this product and shall have no liability in respect of any loss, injury or damage whatsoever arising out of the application or use of any product or circuit described herein.

Every effort has been made to ensure accuracy of this documentation, but Pulsar Measurement cannot be held liable for any errors.

Pulsar Measurement operates a policy of constant development and improvement and reserves the right to amend technical details, as necessary.

The dBi shown on the cover of this manual is used for illustrative purposes only and may not be representative of the actual dBi supplied.

***CONTACT***

For technical support, please contact:

Europe: [supporteurope@pulsarmeasurement.com](mailto:supporteurope@pulsarmeasurement.com)

Outside Europe: [supportnorthamerica@pulsarmeasurement.com](mailto:supportnorthamerica@pulsarmeasurement.com)

If you have any comments or suggestions about this product, please contact:

Europe: [europe@pulsarmeasurement.com](mailto:europe@pulsarmeasurement.com)

Outside Europe: [northamerica@pulsarmeasurement.com](mailto:northamerica@pulsarmeasurement.com)

Pulsar Measurement website: [www.pulsarmeasurement.com](http://www.pulsarmeasurement.com)

**United States**

11451 Belcher Road South  
Largo,  
FL 33773  
888-473-9546

**Canada**

16456 Sixsmith Drive  
Long Sault, Ont.  
K0C 1P0  
855-300-9151

**United Kingdom**

Cardinal Building, Enigma  
Commercial Centre  
Sandy's Road, Malvern  
WR14 1JJ  
00 44 (0)1684 891371

## CONTENTS

Chapter 1: Start Here.....	6
About this Manual .....	6
About the dBi Series (HART) Intelligent Transducer .....	7
Functional Description .....	7
Product Specification.....	9
EU Declaration of Conformity .....	11
Chapter 2 Installation .....	12
Unpacking .....	12
Power Supply Requirements.....	12
Dimensions .....	13
Outdoor and Open Vessel Installation .....	15
Closed Vessel Installation .....	16
Cable .....	17
Typical wiring for a Non-Hazardous location .....	18
Preparation for Operation .....	19
Maintenance .....	20
Hazardous Area Installation.....	20
Chapter 3 How To Use Your dBi Sensor .....	25
4-20 mA Device .....	25
Accessing Parameters.....	26
Hart Commands.....	26
dBi Hart PC Lite.....	26
Parameter Defaults.....	31
Chapter 4 Getting Results From Your dBi Sensor .....	32
Setting up Your Application.....	32
Setting Security Passcodes.....	33
Resetting Factory Defaults.....	33
Checking the Information Specific to your dBi Intelligent Transducer.....	34
Chapter 5 Parameter Listing and Description .....	35

Application.....	35
Operation .....	35
Distances .....	35
Data Logs .....	37
Volume .....	39
Conversion.....	39
Conversion.....	39
Breakpoints.....	44
Tables.....	45
mA Output.....	46
Stability.....	49
System .....	49
DATEM.....	51
Chapter 6 Troubleshooting.....	53
Chapter 7 Disposal .....	54
Transducers .....	54
Controllers.....	54

## CHAPTER 1: START HERE...

Congratulations on your purchase of a Pulsar dBi Series Intelligent Transducer Level Monitoring System. This quality system has been developed over many years and represents the latest in high technology ultrasonic level measurement and control. It has been designed to give you years of trouble-free performance, and a few minutes spent reading this operating manual will ensure that your installation is as simple as possible.

### *About this Manual*

**It is important that this manual is referred to for correct installation and operation.** There are various parts of the manual that offer additional help or information as shown.

### *Tips*



TIP: Look for this icon throughout your Pulsar Measurement manual to find helpful information and answers to frequently asked questions.

### *Additional Information*

#### **Additional Information**

At various parts of the manual, you will find sections like this that explain specific things in more detail.

## *About the dBi Series (HART) Intelligent Transducer*



### *Functional Description*

The dBi Series Intelligent Transducer is a highly developed ultrasonic level measurement system which provides non-contacting level measurement for a wide variety of applications in both liquids and solids. Its unique design gives unrivalled performance in echo discrimination and accuracy in a loop powered device.

Easy calibration and maintenance free "fit and forget" performance mean that you can install the dBi Series Intelligent Transducer Level Monitoring System rapidly and with confidence, with calibration being achieved either using a HART programmer/calibrator, or via a PC utilising the Pulsar interface and software.

The dBi Series Intelligent Transducer operates on the principle of timing the echo received from a measured pulse of sound transmitted in air and utilises "state of the art" echo extraction technology.

dBi Series Intelligent Transducer comes in four models:

1. dBi 3 with a range from 0.125m (0.41 feet) to 3.00m (9.84 feet).
2. dBi 6 with a range of 0.3m (0.98 feet) to 6.00m (19.69 feet).
3. dBi 10 with a range of 0.3m (0.98 feet) to 10.00m (32.81 feet).
4. dBi 15 with a range of 0.5m (1.64 feet) to 15.00m (49.213 feet).

All models can be mounted via a rear, 1" BSP/NPT, thread (Standard) with a model with alternative front thread mounting being available, in addition to this flange mount and PVDF options are also available. See **Chapter 2 Installation** for further details.

All model types are available for use in hazardous area installations with either Ex mb or Ex ia ATEX certification.

The dBi Series Intelligent Transducer has a 4 to 20mA output which can be programmed to give an output proportional to **level, space, distance or volume**, dependant on the measurement mode selected and provides a 'fault condition' alarm of either 3.8mA or 22mA.

Boot time for the dBi Series intelligent Transducer from power up to stable reading: cold boot = 9 seconds, warm boot = 4 seconds (if within 12hrs from last start up). For 4 to 20ma set proportional to measured level/distance.



## Product Specification

### PHYSICAL

<b>Dimensions &amp; Mounting</b>	<p><b>dBi3:</b> 77mm dia x 134mm high (3 x 5.31 inch) Rear thread 1" BSP/NPT</p> <p><b>dBi6 &amp; dBi10:</b> 86mm dia x 121 high (3.38 x 4.75 inch). Rear thread 1" BSP/NPT</p> <p><b>dBi15:</b> 86mm dia x 134 mm high (3.38 x 5.32 inch). Rear 1" BSP/NPT</p>
<b>Weight</b>	<p><b>dBi3:</b> 1kg (2.2lbs), <b>dBi6:</b> 1.2kg (2.7lbs)</p> <p><b>dBi10:</b> 1.3kg (2.9lbs), <b>dBi15:</b> 1.4kg (3.1lbs)</p>
<b>Enclosure material/description</b>	Valox 357
<b>Transducer cable requirements</b>	2 core screened. Integral cable length 5, 10, 20 or 30m

### ENVIRONMENTAL

<b>Enclosure protection (all models)</b>	IP68
<b>Temperature Compensation</b>	Internal temperature sensor, $\pm 0.5^{\circ}\text{C}$
<b>Max. &amp; min. temperature (electronics)</b>	$-40^{\circ}\text{C}$ to $+80^{\circ}\text{C}$ ( $-40^{\circ}\text{F}$ to $176^{\circ}\text{F}$ )
<b>CE Approval</b>	See EU Declaration of Conformity
<b>ATEX</b>	<p>II 1 G Ex ia IIC T4 Ga, II 1 D Ex ia IIIC T130°C Da Tamb <math>-40^{\circ}\text{C}</math> to <math>+80^{\circ}\text{C}</math></p> <p>II 2 E Ex mb IIC T4 Gb, II 2 D Exmb IIIC T130°C Db Tamb <math>-40^{\circ}\text{C}</math> to <math>+80^{\circ}\text{C}</math></p>

### PERFORMANCE

<b>Measurement Range</b>	<p><b>dBi3:</b> 0.125m (0.41 ft.) to 3.00m (9.84 ft.)</p> <p><b>dBi6:</b> 0.3m (0.98 ft.) to 6.00m (19.69 ft.)</p> <p><b>dBi10:</b> 0.3m (0.98 ft.) to 10.00m (32.81ft.)</p> <p><b>dBi15:</b> 0.5m (1.64 ft.) to 15.00m (49.213 ft.)</p>
<b>Accuracy/Repeatability</b>	<p><b>dBi3:</b> 2mm (0.08 inch)</p> <p><b>dBi6:</b> 4mm (0.16 inch)</p> <p><b>dBi10:</b> 3mm (0.12 inch) up to 6m (20ft.) range 6mm (0.24 inch) over 6m range</p> <p><b>dBi15:</b> 5mm (0.2 inch) up to 10m (33ft.) range 10mm (0.39 inch) over 10m range</p>
<b>Frequency</b>	<p><b>dBi3:</b> 125kHz</p> <p><b>dBi6:</b> 75kHz</p> <p><b>dBi10:</b> 50kHz</p> <p><b>dBi15:</b> 41kHz</p>
<b>Beam Angle</b>	<b>dBi3, dBi6 &amp; dBi10:</b> $<10^{\circ}$

**dBi15: <8°** (all beam angles are inclusive, but give an effective beam angle of <3°)

---

## OUTPUTS

<b>Digital Communications</b>	FSK (Frequency Shift Keying) modulation of 1200-2400Hz
<b>Communication Protocol</b>	HART 7, 4-20mA loop powered, output resolution 1µA

---

## PROGRAMMING

<b>PC programming (via HART modem and 250 Ohm resistor)</b>	HART PC Lite (setup only), Pulsar PC Suite- and 250 Ohm resistor). HART PC (setup, installation, echo profiles, cloning and troubleshooting).
<b>Program security</b>	Via passcode
<b>Programmed data integrity</b>	Via non-volatile RAM
<b>PC Setup and monitoring</b>	Compatible with Win 7, Win 8 and Win 10

---

## SUPPLY

<b>Power supply</b>	10 - 28V DC
<b>Power Consumption</b>	Current consumption at start-up = 12mA, unit powered every 15 minutes for 4 seconds the average current = 53µA

Pulsar Measurement operates a policy of constant development and improvement and reserve the right to amend technical details, as necessary.

**EU Declaration of Conformity**

DoC ref. 001001

**EU DECLARATION OF CONFORMITY****P U L S A R dBi-HART range.**

This declaration of conformity is issued under the sole responsibility of the manufacturer.

Relevant Directive(s)	2014/35/EU - LVD directive and it's amending directives. 2014/30/EU - EMC directive and it's amending directives. 2014/34/EU - ATEX directive and it's amending directives. 2011/65/EU - RoHS directive and it's amending directives.
Manufacturer's Name	Pulsar Process Measurement Ltd.
Manufacturer's address	Cardinal Building, Enigma Commercial Centre, Sandy's Road, Malvern, Worcestershire, WR14 1JJ, UK.
Apparatus	DC powered ultrasonic transducers.
Models	dBi-3, dBi-6, dBi-10, dBi-15. Exia and Exmb versions.
Type of equipment	Measurement and process control.
Standards applied	EN61010-1:2010+A1:2019. EN61326-1:2013, equipment class industrial. EN60079-0:2012+A11:2013. EN60079-11:2012 (Ex ia). EN60079-18:2015+A1:2017 (Ex mb).
Notified body	Element Rotterdam B.V. #2812.
Role	Issue of ATEX / IECEx EU type examination certificates.
Auditing body	CSA Group Netherlands B.V. #2813.

I declare that the apparatus named above has been tested and complies with the relevant sections of the above referenced standards & directives.

Signed for and on behalf of:

A handwritten signature in black ink, appearing to read "Tim Brown".

Date: 1st April 2021.

Rev. 1.2 .

Name &amp; function:

Tim Brown, Electronics Engineer

Pulsar Process Measurement Ltd.

## CHAPTER 2 INSTALLATION

### Unpacking

#### Important Notice

All shipping cartons should be opened carefully. When using a box cutter, do not plunge the blade deeply into the box, as it could potentially cut or scratch equipment components. Carefully remove equipment from each carton, checking it against the packing list before discarding any packing material. If there is any shortage or obvious shipping damage to the equipment, report it immediately to Pulsar Measurement.

### Power Supply Requirements

The dBi Series Intelligent Transducer operates from a DC supply of 10 to 28V and will typically draw less than 22mA.

The compact one-piece construction of the dBi Series Intelligent Transducer can be mounted easily using either the 1" BSP/NPT rear mounting thread or the integral 1.5" or 2" BSP/ NPT, nose thread, dependent on model.

When choosing a location to mount the dBi Series Intelligent Transducer, bear in mind the following:

- The ultrasonic signal path should be free of falling material and obstructions such as pipes, beams etc.
- The dBi 3 should be mounted at least 12.5cm (0.41 feet) above the maximum level of the material and be perpendicular to the surface. While the dBi 6 and 10 should be mounted at least 30cm (0.98 feet) above the maximum level of the material and be perpendicular to the surface. And the dBi 15 should be mounted at least 50cm (1.64 feet) above the maximum level of the material and again should be perpendicular to the surface.
- The ambient temperature is between -40°C and 80°C.
- There should be no high voltage cables or electrical inverter wiring near the transducer cabling.

#### Important Notice

All electronic products are susceptible to electrostatic shock, so follow proper grounding procedures during installation.

**Dimensions**

The dimensions of the dBiSeries Intelligent Transducer are shown below:

*Rear Thread Mount*

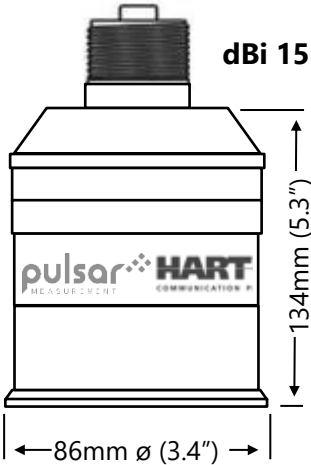
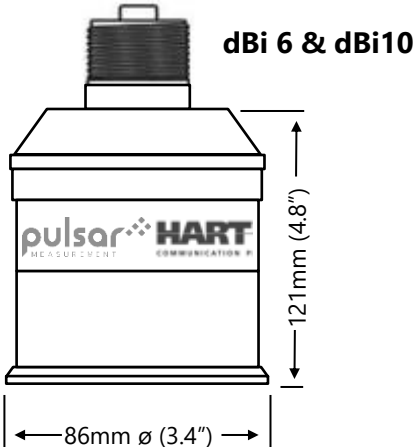
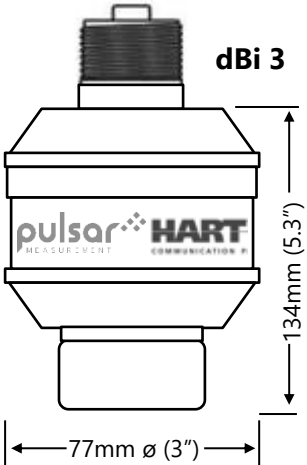

*Front Thread Mount*

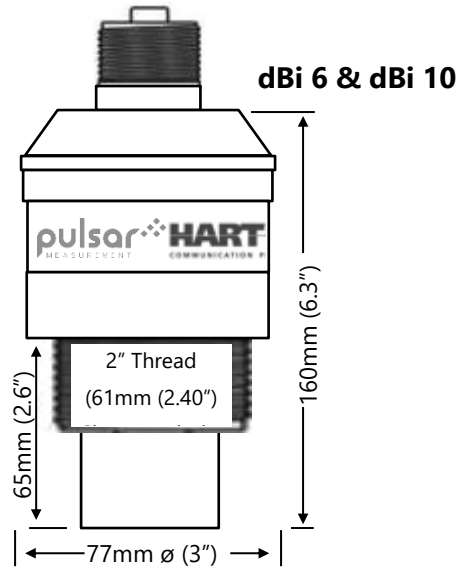
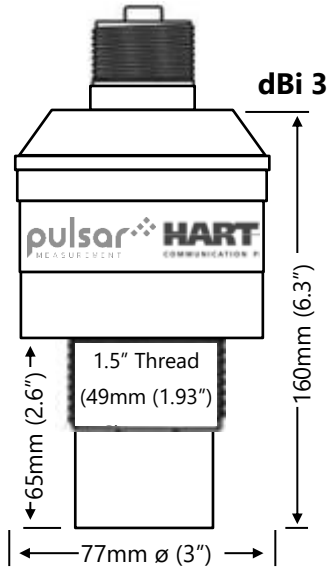

### Outdoor and Open Vessel Installation

The dBi Series Intelligent Transducer can be simply mounted on a bracket, suitable for the application and secured using either the 1" BSP/NPT rear thread or via the 1½" or 2" front thread, dependant on model.

Care should be taken to ensure that the dBi Series Intelligent Transducer is not installed in direct sunlight, to avoid errors in the measurement of ambient temperature.

Attention should also be taken, when mounting the unit, to ensure that strong windy conditions are avoided, wherever possible, to prevent abnormal operation.

DBI MODEL	RANGE	L = BLANKING
dBi 3	3 metres (9.84 feet)	125mm (0.41 feet)
dBi 6	6 metres (19.69 feet)	300mm (0.98 feet)
dBi 10	10 metres (32.18 feet)	300mm (0.98 feet)
dBi 15	15 metres (49.21 feet)	500mm (1.64 feet)

**'L' (Blanking) should, as a minimum be at least that as detailed in the table above but can be greater if required.**

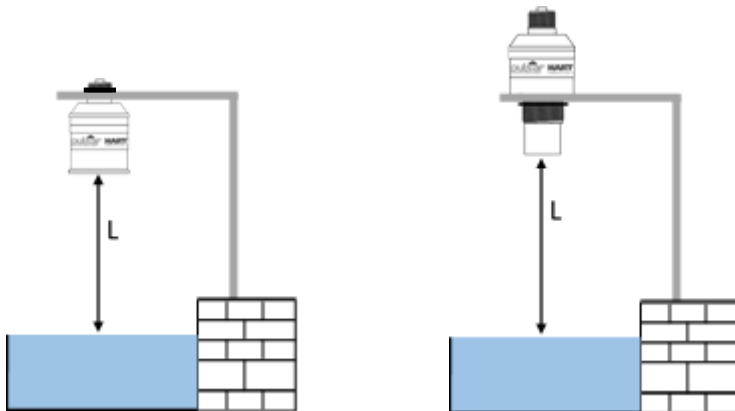

Mounted via Rear 1" BSP/NPT Thread

Mounted via optional Front Thread

**Closed Vessel Installation**

"L" should as a minimum be at least that as detailed in the table above but can be greater if required. The dBi Series Intelligent Transducer can be simply screwed into a flange and secured using the rear 1" BSP/NPT rear thread or via the 1½" or 2" front thread, dependant on model.

Where possible, use a flange made of a synthetic material such as PVC, in cases where a metal flange is used it is advisable to fit a suitable gasket between the flange of the dBi Series Intelligent Transducer and the connection to the vessel.

**Standpipe Installations**

When mounting the dBi Series Intelligent Transducer to a standpipe care should be taken to ensure that the standpipe is of sufficient diameter with reference to its length, see the table below for details:

DIA. (D)		MAX LENGTH	
mm	inches	mm	inches
80	3	220	8
100	4	300	12
150	6	420	16
200	8	560	22

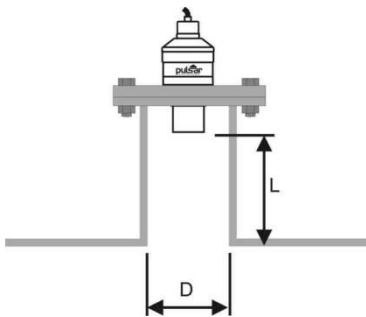

dBi Flange mounted via Front Thread

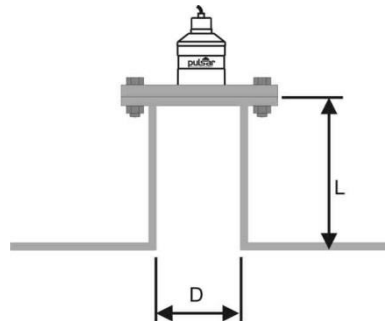

Optional Flange Mounted dBi



When using a standpipe, fixed to the top of a vessel, ensure that the open end of the standpipe is clear of any obstructions such as weld seams, gaskets etc. to avoid unwanted signal returns.

If using standpipes which extend into the vessel, beyond the blanking distance, but not as far as the empty level, then the open end of the standpipe should be cut to an angle of 45°.

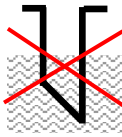

The maximum level (100% of Span) is inside the Blanking Distance.

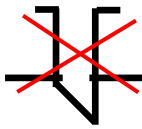

Pipe should be free of obstructions such as weld seams.



Correct standpipe installation

When using the dBi Series Intelligent Transducer to measure 'aggressive, materials such as 'alkaline' and 'acids' it is recommended that either a PVDF or an optional PTFE faced Flanged Transducer is used. Please consult Pulsar for full availability of options.

### Cable

The dBi Series Intelligent Transducer comes with a fitted integral cable, if this cable is extended then the total capacitance must not exceed the limits for the voltage applied.

#### Important Notice

In the case of the Ex mb version the cable is fitted with an over current protection device in the form of a fuse, please note that **under no circumstances should this fuse be removed**. The fuse must be fitted in the non-hazardous area.

*Typical wiring for a Non-Hazardous location*

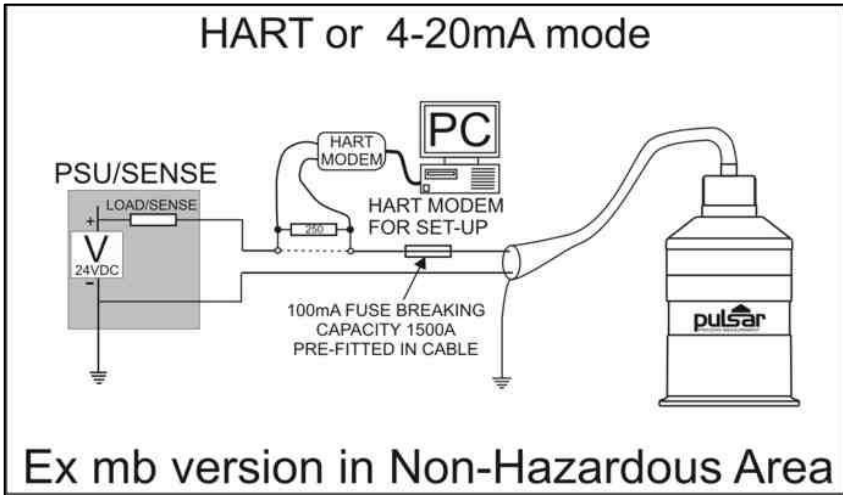

The HART modem and PC or HART programmer are used to set up the operation parameters for the dBi transducer. The output can either be as a 4-20mA current giving level or distance or as a digital signal via a HART master.

The dBi transducers cable is a twisted pair with overall cable screen. The twisted pair are red and black, connect the red to +ve and the black to -ve. The screen should go to signal ground.

### Loop Resistance

For two wire operation, the maximum cable resistance allowable can be calculated from the graph below. For example, if an dBi Series Intelligent Transducer was supplied from 24V, the maximum total cable resistance is 600 ohms, for a typical 77 ohm /km cable this would mean a maximum cable length of  $600/77 = 7.8\text{km}$ , remember this total cable resistance, so this figure must be divided by 2 to give 3.9km max distance.

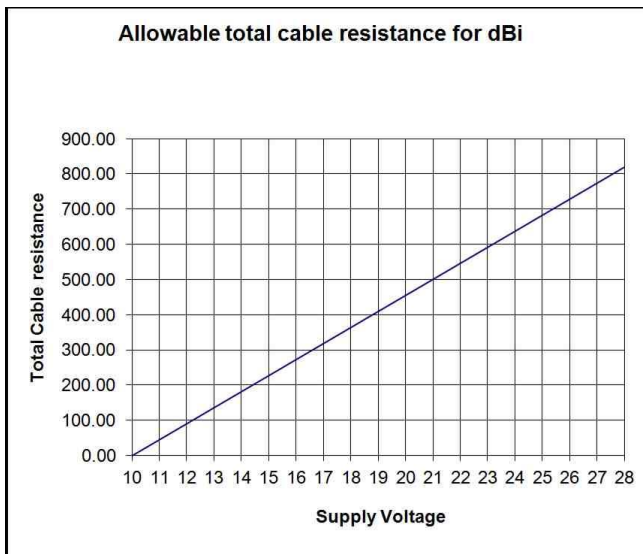

**Maximum cable resistance vs supply voltage.**

#### Important Notice

If the equipment is installed or used in a manner not specified in this manual, then the protection provided by the equipment may be impaired.

### Preparation for Operation

Before switching on, check the following:

- ✓ The dBi Series Intelligent Transducer is mounted correctly.
- ✓ The power supply is correctly installed.

## **Maintenance**

There are no user serviceable parts inside your dBi Series Intelligent Transducer, if you experience any problems with the unit, then please contact Pulsar Process Measurement for advice.

To clean the equipment, wipe with a damp cloth. Do not use any solvents on the enclosure.

## **Hazardous Area Installation**

### *Information specific to Hazardous Area Installation*

#### **(Reference European ATEX Directive 2014/34/EU, Annex II, 1.0.6.)**

The following instructions apply to equipment covered by certificate number EMT18ATEX0014X (Ex ia) & TRAC 12ATEX0023X (Ex mb)

1. The equipment may be used with flammable gases and vapours with apparatus groups IIC, IIB, and IIA with temperature classes; T1, T2, T3, T4 maximum ambient temperature range -40°C to +80°C.
2. The equipment is only certified for use in ambient temperatures in the range -40°C to +80°C and should not be used outside this range
3. Installation shall be carried out in accordance with the applicable code of practice by suitably trained personnel
4. Repair of this equipment shall be carried out in accordance with the applicable code of practice.
5. Certification marking as detailed in drawing number **D-804-0957-B** (Ex ia) & **D-804-0994-A** (Ex mb).
6. If the equipment is likely to come into contact with aggressive substances, then it is the responsibility of the user to take suitable precautions that prevent it from being adversely affected, thus ensuring that the type of protection is not compromised.

Aggressive Substances - e.g. acidic liquids or gases that may attack metals or solvents that may affect polymeric materials.

Suitable Precautions - e.g. regular checks as part of routine inspections or establishing from the material's data sheet that it is resistant to specific chemicals.

7. The certificate number has an 'X' suffix that indicates that the following special condition of certification applies;  
In the case of dBi transducer range, due to the housing and labels being non-conductive plastic care needs to be taken with regards electrostatic charge. The equipment shall not be installed if the conditions are conducive to the build-up of electrostatic charge. Additionally, the equipment should only be cleaned with a damp cloth.  
With the dBi Ex mb version a 100mA, 1500A breaking capacity fuse must be fitted in the positive lead of the cable. The product is shipped with this fuse in the cable, visible through the heat shrink at the wire end of the cable
8. The manufacturer should note that, on being put into service, the equipment must be accompanied by a translation of the instructions in the language or languages of the country in which the equipment is to be used and by the instructions in the original language.

#### *Hazardous Area Specific Power Supply and barrier Requirements*

The dBi transducer operates from a DC supply of 10 –28V and will typically draw less than 22mA.

**In the case of the Ex ia version the unit must be powered from an approved I.S. safety barrier or approved I.S. Power supply with the following limits:**

$U_o \leq 28V$ ,  $I_o \leq 162mA$ ,  $P_o \leq 1.03W$

**In the case of the Ex mb version the unit must be powered from a power supply and 100mA fuse (1500A breaking capacity) to give prospective short current of 1500A. This fuse (100mA leaded Little fuse series 242) is fitted in the cable of the Ex mb version of dBi transducers. The power supply should have the following rating:**

$U_m = 28V$

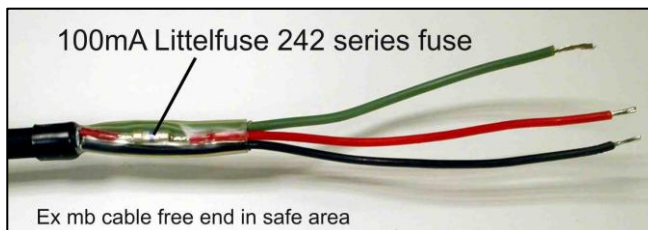

The dBi transducers cable is a twisted pair with overall cable screen. The twisted pair are red and black, connect the red to +ve and the black to -ve. The screen should go to signal ground.

Typical wiring for the two types of dBi transducers:

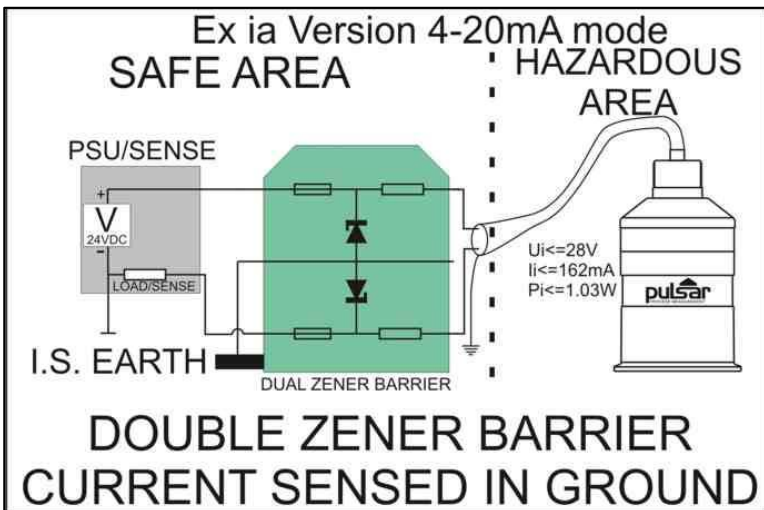
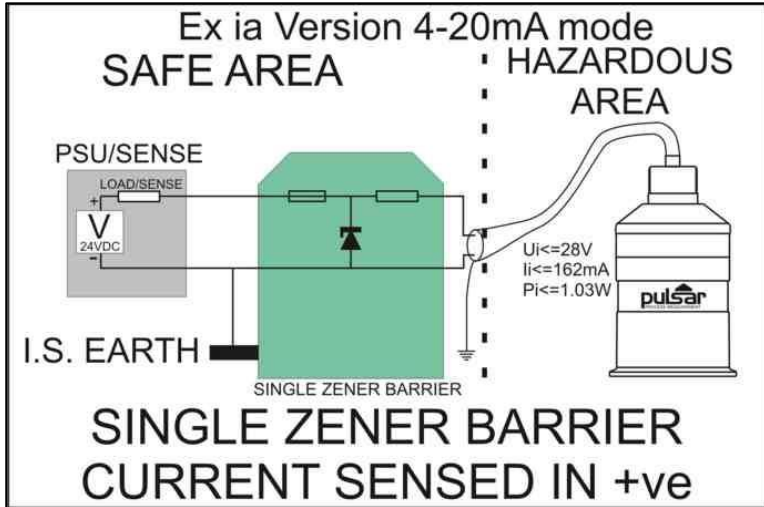

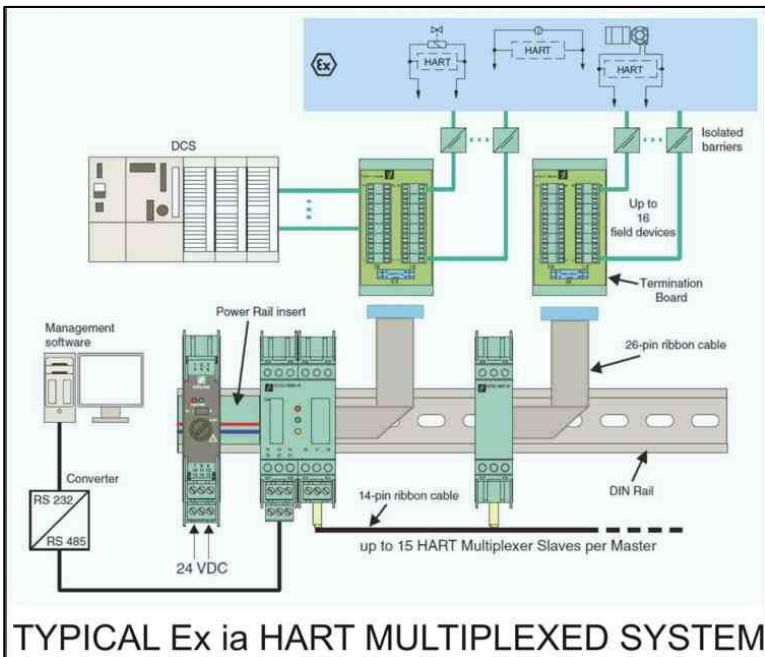
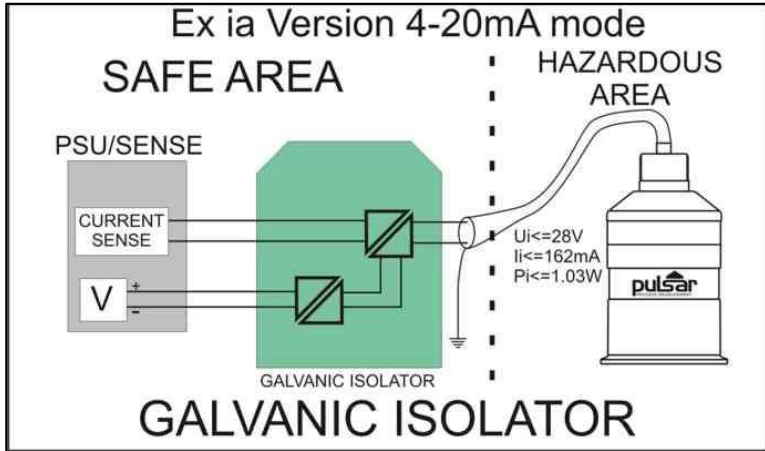

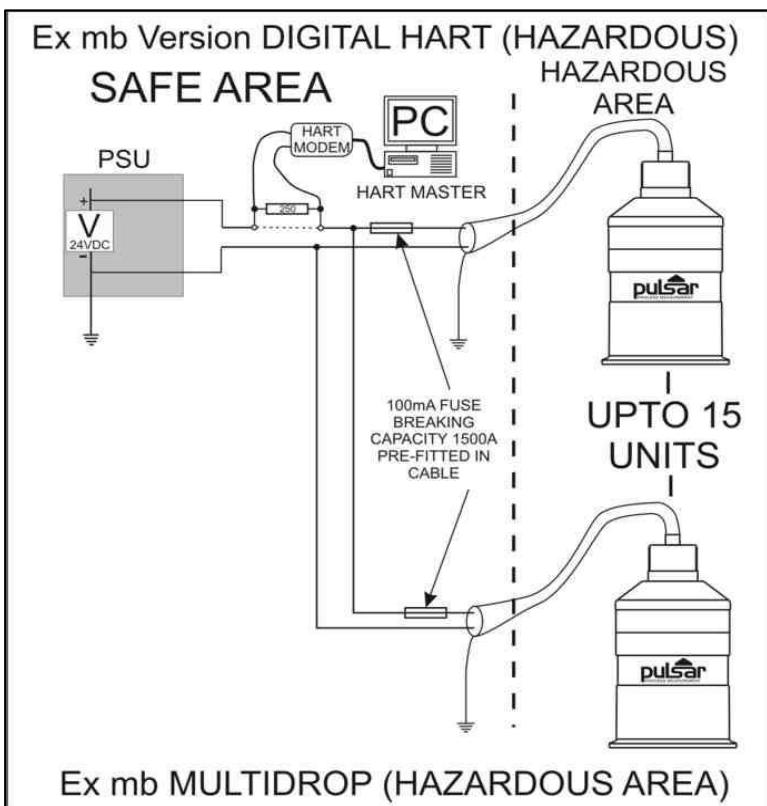
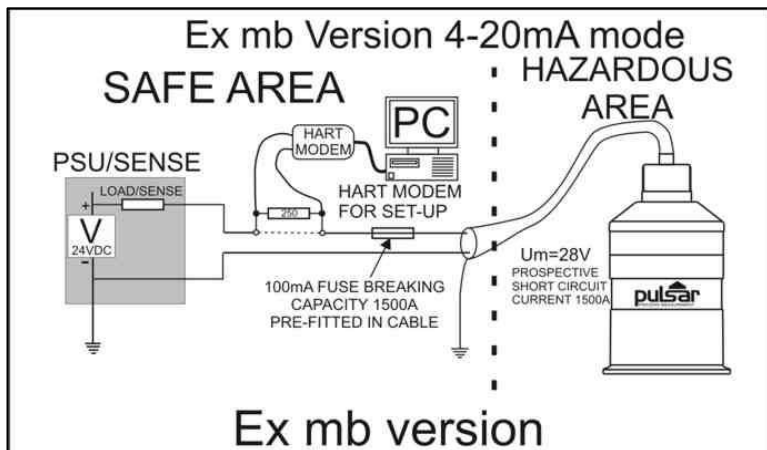



## CHAPTER 3 HOW TO USE YOUR DBI SENSOR

### 4-20 mA Device

The dBi Hart Intelligent Transducer can be used as an 'out of the box' 4 – 20mA device if this is the case then by default, when you switch the dBi Series Intelligent Transducer on, the 4 – 20mA output will be proportional to the **level** being seen, with respect to the maximum range and span of the dBi model being used as detailed in the table below.

	DBI 3	DBI 6	DBI 10	DBI 15
4 mA (Empty) 0% of Span Distance from dBi Face in metres	3.000	6.000	10.000	15.000
20 mA (Full) 100% of Span Distance from dBi Face in metres	0.125	0.300	0.300	0.500

#### Important Notice

Customised factory calibration of Span is available; please contact Pulsar for further details.

#### Important Notice

When the dBi Series Intelligent Transducer is operated below 8mA then the speed of response will decrease. See the following table for cycle times:

#### LOOP CURRENT DRAW

TYPE	3.8	4	5	6	7	8	9
dBi3	5.6	3.8	1.5	1	1	1	1
dBi6	7.5	4.8	2	1.2	1	1	1
dBi10	9.8	6.6	2.7	1.7	1.3	1.05	1
dBi15	10.9	7.5	3.2	2	1.4	1.1	1

Time in seconds between firing: For example – if using a dBi 6 and the target is causing a current draw of 5mA then the cycle time (the time between measurements) is 2 seconds.

Any transducer drawing 9mA or above will have a cycle time of 1 second.

### ***Accessing Parameters***

To view or change parameters values one of the following methods must be used:

#### ***Hart Commands***

If familiar with the use of HART protocol and the dBi Series Intelligent Transducer is connected to a HART modem, then it can be programmed following normal HART procedures.

Commands implemented by the dBi Series Intelligent Transducer are as follows:

#### ***Universal***

0, 1, 2, 3, 6, 7, 8, 9, 11, 12, 13, 14, 15, 16, 17, 18, 19, 20, 21, 22, 38 and 48.

#### ***Common practice***

33, 34, 35, 40, 41, 42, 45, 46, 47, 83, 89, 90, 111, 112 and 122.

#### ***dBi Hart PC Lite***

Your dBi Series Intelligent Transducer comes complete with the dBi HART PC Lite software contained on CD, which, when used with a HART Modem, see **Chapter 2 Installation** for full details on how to connect the modem, can be used to carry out the programming of the dBi Series Intelligent Transducer.

Insert the CD into the CD drive or download the software from the Pulsar website (onto the PC intended to be used to carry out the programming of the dBi Series Intelligent Transducer and install the software, following the on-screen instructions.

Once the software is installed connect the computer via a convenient USB port to the HART Modem. Double click the 'dBi HART PC Lite' icon, installed on your desktop and the programme will open and you will see the following screen:

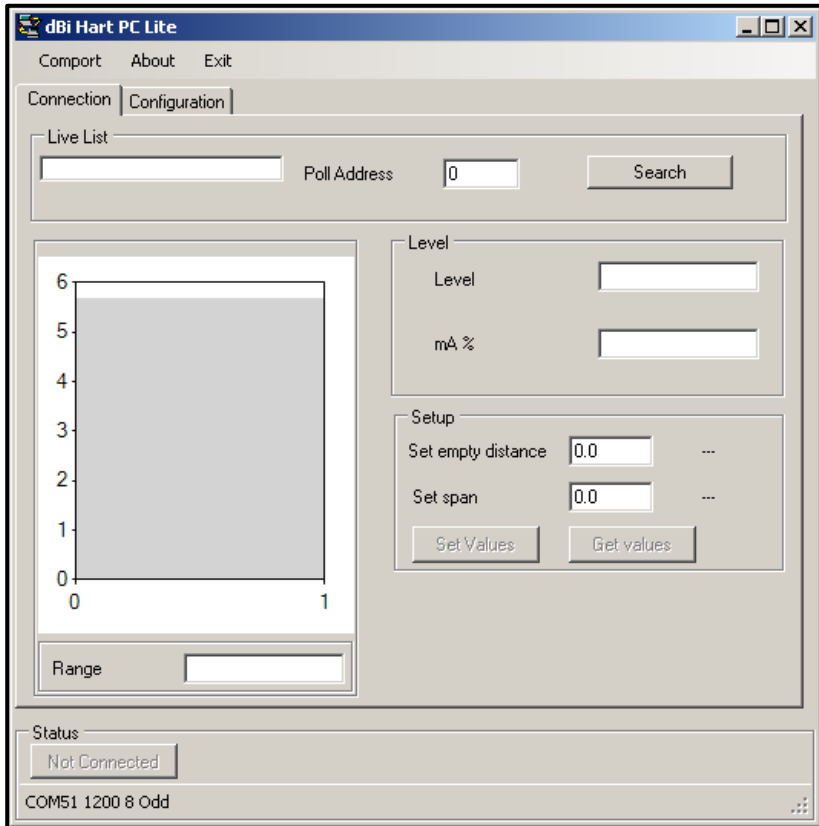

To connect to the dBi Series Intelligent Transducer 'click' on the 'Search' button which will then change to 'Scanning' and once a connection with a device has been established it will change to 'Connected' and the 'Status' button will show 'Connected' and flash Green, if the dBi HART PC Lite fails to connect please check the Comport Configuration as detailed on page 29. When using the dBi HART PC Lite software, keypad input can be achieved by using a 'mouse' or similar device to place the cursor over the relevant key followed by a 'left' click, with numeric detail being entered directly from the PC keyboard.

Once dBi HART PC Lite has successfully connected you will see the following display:

Connection

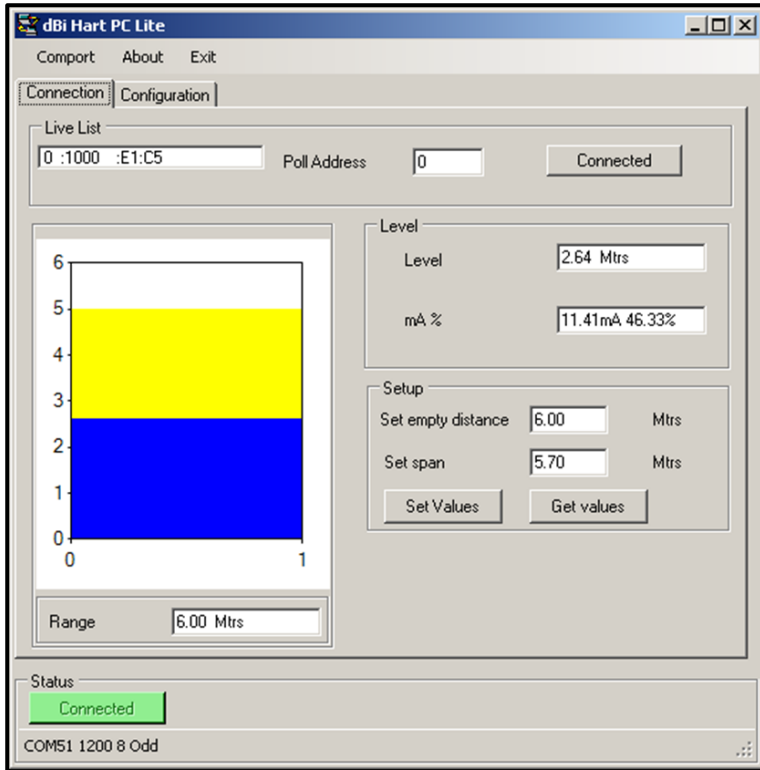

On the opening screen the following Information is available:

**Live List**

Gives details of all devices connected, if more than one device is present the 'Live List' will become a drop-down box and the required device selected.

**Poll Address**

Gives the Poll Address of the selected Device. By default, this polling address is set to '0' on the dBi and can be changed via a HART command on HART Lite PC or HART PC in PC Suite.

When using multiple HART devices (multi-drop mode) i.e. MicroFlow-i, the poll address on the dBi will need to be changed. When the poll address is changed to anything other than '0', the dBi will be in a fixed current mode, drawing 12mA constantly.

**Level**

Gives value of the Level in the vessel in Measurement Units (P104)

**mA %**

Gives current value of the mA Output and how full the vessel is in percentage.

**Set Empty Distance**

Allows the Empty Distance to be set.

**Set Span**

Allows the Span to be set which will determine the range of the 4 to 20mA output, with 4mA representing 0% (empty) and 20mA representing 100% (full).

**Range**

Shows the maximum range that can be measured, by the dBi Series Intelligent Transducer, that is currently connected.

**Bar Graph Display**

Gives a graphical indication of the Empty Distance (P105) and Maximum Span (P106) along with current level being measured.

*Configuration*

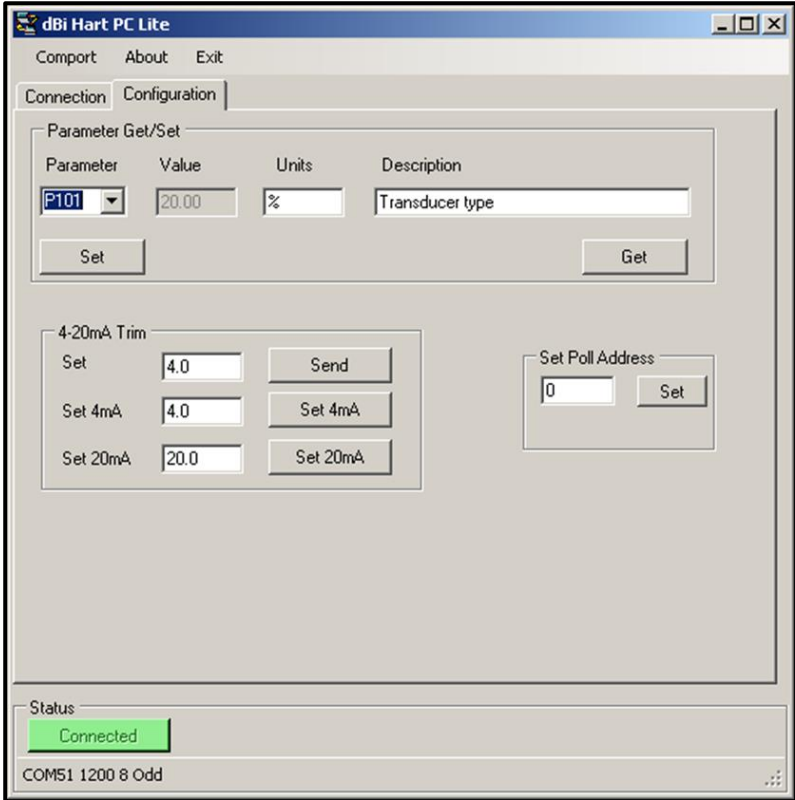

*Parameter Get/Set*

**Get:**

Will read and display the current value of the parameter selected along with the 'units' of measurement, where used, and the description of the parameter selected. Select the desired parameter form the drop down 'Parameter' box and 'click' 'Get'

**Set:**

Allows the value of the selected parameter to be changed. Select the desired parameter form the drop down 'Parameter' box, enter required value in the 'Value' box and 'click' 'Set'

For a full list of available parameters see [Chapter 5 Parameter Guide](#).

### 4 – 20mA Trim

If the device connected to the mA output is out of calibration, and cannot be calibrated, then the low and high current levels can be trimmed by altering **Set 4mA** (P838Low Trim) and **Set 20mA** (P839 High Trim). To do this, simply enter the value that ensures that 4 mA or 20 mA respectively are shown on the remote device.

### Communication Port Configuration

If the dBi HART PC Lite fails to connect to the dBi Series Intelligent Transducer you may need to change the communications port that is being used, to do this 'click' on the 'Comport' menu in the top menu bar and the 'Comm Port Setup' window will appear, select the appropriate communications port, and then close the window.

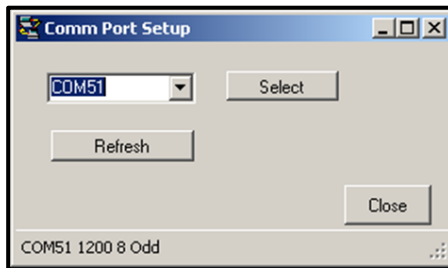

## Parameter Defaults

### Factory Defaults

#### Important Notice

When first installing **the** dBi Series Intelligent Transducer, or subsequently moving or using the unit on a new application, before proceeding to program the unit for its intended application it is recommended that you ensure that all parameters are at their default values by completing a **Factory Defaults P930**, as described in [Chapter 5 Parameter Guide](#).

Once you are satisfied with the installation, and the dBi Series Intelligent Transducer is reading what you would expect in terms of distance from the face of the transducer to the material level, then you can proceed with any programming, required for the intended application. It is sensible to program all the required parameters at the same time. The system will be then set-up.

## CHAPTER 4 GETTING RESULTS FROM YOUR DBI SENSOR

This chapter explains how to undertake the various functions of your dBi Series Intelligent Transducer. Where specific parameters are used, consult Parameter Guide in Chapter 5.

### *Setting up Your Application*

#### *Empty Distance*

**Empty Distance (P105)** is the distance from the face of the transducer to the material at the bottom of the vessel.

#### *Span*

**Span (P106)** is the distance from the empty level (0% full) to span (100% full).

#### *Near and Far Blanking*

**Near blanking (P107)** is the distance from the face of the transducer that the dBi Series Intelligent Transducer will not record a level nearer than. A typical reason to increase this from the default value would be if you wish to ignore close in obstructions.

**Far blanking (P108)** is the distance (as a percentage of empty level) beyond the empty level that the dBi Series Intelligent Transducer will read, the default is plus 20% of empty level. If you wish to monitor further than the **empty level**, then increase this figure, so that the **empty level** plus the **far blanking** figure (as % of empty level) is greater than the surface being measured, within the capability of the transducer being used.

### **Using the 4-20 mA Output**

The mA output can be used to monitor remotely what the dBi Series Intelligent Transducer is measuring, so it can be displayed remotely, integrated into a PLC, or used to generate a record using a chart recorder or similar.

By default, the dBi Series Intelligent Transducer will provide a 4-20 mA output that is proportional to **level** and can be overwritten as follows.



By default, the 4-20 mA will represent the operational span of the dBi model in use, with empty (0% full) = 4mA and full (100% of the operational span) = 20mA, but you may wish to only represent a section of the operational span. For example, the application may have an operational span of 6 metres, but you may only wish to represent empty level to 5 metres. If so, change **P834 (Low Value)** to **0**, and **P835 (High Value)** to **5.0**.

If the device connected to the mA output is out of calibration, and cannot be calibrated, then the low and high current levels can be trimmed by altering **P838 (Low Trim)** and **P839 (High Trim)**. To do this, simply enter the value that ensures that 4 mA or 20 mA respectively are shown on the remote device. You can use the left/right menu keys to alter the value until the correct reading is shown on the remote device, rather than typing in a value.

### *Setting Security Passcodes*

A passcode is used to protect parameter entries and will be required when accessing parameters with certain PC Software's. You can set a new passcode to prevent anyone changing any of your settings within your dBi Series Intelligent Transducer. The default **passcode** is **1997**, but this may be changed as follows.

#### **Important Notice**

The passcode is also used for remote access using certain PC Software's, so if this is being used, be sure to ensure any additional equipment using this feature is changed accordingly.

### *Changing the Passcode*

You can set the **passcode** to any number from 0000 to 9999. To do this, select **P922** which is the **Passcode** parameter which can be changed as required.

### *Resetting Factory Defaults*

If you need to restore parameters to their original factory settings, then access parameter **P930**, which is the factory defaults parameter, change the value to **1** and **ENTER**, all parameters, except for the mA trims, will be restored to the factory settings (including the DATEM trace) and on completion.

### *Checking the Information Specific to your dBi Intelligent Transducer*

There are some parameters dedicated to each individual dBi Series Intelligent Transducer, such as the software revision and the unit's serial number.

#### *Checking the Software Revision and Serial Number*

If you need to identify the serial number of the unit or the current level of software in your dBi Series Intelligent Transducer, the following parameters can be used. Select parameter **P926** to view the identity of the current software **revision** or **P928** for the **serial number** of the unit.

## CHAPTER 5 PARAMETER LISTING AND DESCRIPTION

### Application

#### Operation

##### *P100 Mode of Operation*

This parameter sets the mode of operation, when in run mode, and can be set to one of the following:

OPTION	DERIPTIONS
1= Distance	Display shows the distance from the transducer face to the surface.
<b>2= Level (Default)</b>	Display shows how full the vessel is.
3= Space	Display shows how empty a vessel is.
4= Volume	Display shows volume of material in the vessel

##### *P102 Material*

This parameter should be set to the type of material being monitored.

OPTION	DERIPTIONS
<b>1 = Liquid (Default)</b>	Use for liquids and flat solid materials
2 = Solid	Solid material that is heaped or at an angle
3 = Closed Tank	Use for closed tanks or domed roofs.

### Distances

##### *P104 Measurement Units*

This parameter sets the units you want to use for programming and display

OPTION	DERIPTIONS
1 = metres	All units of measure are <b>METRES</b>
2 = cm	All units of measure are <b>CENTIMETRES</b>
3 = mm	All units of measure are <b>MILLIMETRES</b>
4 = feet	All units of measure are <b>FEET</b>
5 = inches	All units of measure are <b>INCHES</b>

*P105 Empty Level*

This parameter is to be set to the maximum distance from the face of the transducer to the empty point, in **P104 Measurement Units**. Note this value affects span as well, so should be set before span. **Default: dBi 3 = 3.00m (9.84 feet), dBi 6 = 6.00m (19.69 feet), dBi 10 = 10.00m (32.81 feet) and dBi 15 = 15.00m (49.21 feet).**

*P106 Span*

This parameter should be set to the maximum distance from the **Empty Level (P105)** to the maximum material level. It is automatically set to be equal to the **Empty Level (P105)** less the **Near Blanking** distance (**P107**), when you set the empty level. **Default dBi 3 = 2.80m (9.19 feet), dBi 6 = 5.70m (18.70 feet), dBi 10 = 9.70m (31.82 feet) and dBi 15 = 14.5m (47.57)**

*P107 Near Blanking*

This parameter is the distance from the face of the transducer that is not measurable and is pre-set to the minimum value dependant on the version of dBi Series Intelligent Transducer being used. It should not be set to less than this figure but can be increased.

DBI VERSION	NEAR BLANKING DISTANCE
dBi 3 metre	Default Blanking Distance = 0.25m (0.66 feet)
dBi 6 metre	Default Blanking Distance = 0.3m (0.98 feet)
dBi 10 metre	Default Blanking Distance = 0.3m (0.98 feet)
dBi 15 metre	Default Blanking Distance = 0.5m (1.64 feet)

*P108 Far Blanking*

This is the distance (as a **percentage** of empty level) beyond the empty point that the unit will be able to measure, and the **default** is pre-set to **10%** of the empty level.

If the surface being monitored can extend beyond the **Empty Level (P105)** then the far blanking distance can be increased to a maximum of 100% of empty level.

This parameter is always entered as a % of empty level.

## **Data Logs**

The data log parameters contain the following information:

### *Temperature*

The following parameters give information on temperature conditions seen by the **Temperature source (P852)** in °C. These parameters are read only and cannot be changed, though if P852 is changed they will be reset.

#### *P580 Minimum Temperature*

This parameter displays the minimum temperature recorded.

#### *P581 Minimum Temperature Date*

This parameter displays the date when the minimum temperature was recorded.

#### *P582 Minimum Temperature Time*

This parameter displays the time when the minimum temperature was recorded.

#### *P583 Maximum Temperature*

This parameter displays the maximum temperature recorded.

#### *P584 Maximum Temperature Date*

This parameter displays the date when the maximum temperature was recorded.

#### *P585 Maximum Temperature Time*

This parameter displays the time when the maximum temperature was recorded.

#### *P586 Current Temperature*

This parameter displays the current temperature.

### *Transducer Power Information*

The following parameters provide information on when the dBi Series Intelligent Transducer was last powered down and how long it had run for.

*P940 Number of Starts*

This parameter displays the number of times that the unit has been powered since leaving the factory.

*P941 Last Power Off Date*

This parameter displays the last date on which the power was removed from the unit.

*P942 Last Power Off Time*

This parameter displays the last time on which the power was removed from the unit.

*P943 Last Run Time (minutes)*

This parameter displays how long the unit had been running, in minutes, prior to the last power down.

*P944 Last Run Time (hours)*

This parameter displays how long the unit had been running, in hours, prior to the last power down.

*P945 Total Runtime (hours)*

This parameter displays the accumulated total number of hours that the unit has been in operation (powered up) since leaving the factory.

## Volume

### Conversion

#### *P600 Vessel Shape*



This parameter determines which vessel shape is used when utilising "Volume Conversion".



### Conversion

#### *P600 Vessel Shape*

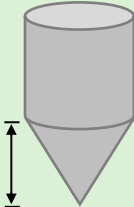

This parameter determines which vessel shape is used when utilising "Volume Conversion".

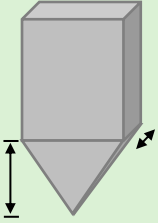
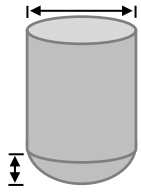
The choices are as shown in the table below, along with the **dimensions** that are required to be entered (**P601-P603**).

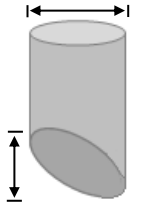
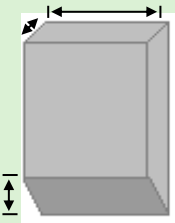
VESSEL SHAPE	P600 VALUE DESCRIPTION	DIMENSIONS
	P600 = 0 ( <b>Default</b> ) Cylindrical Flat Base	Cylinder diameter
	P600 = 1 Rectangular Flat Base	Width and Breadth
	P600 = 2 Cylindrical Cone Base	Cylinder diameter and height of bottom

VESSEL SHAPE	P600 VALUE DESCRIPTION	DIMENSIONS
	<p>P600 = 3 Rectangular Pyramid Base</p>	<p>Height of base, Width and Breadth of Rectangle</p>
	<p>P600 = 4 Parabola Base</p>	<p>Cylinder diameter and height of bottom</p>
	<p>P600 = 5 cylindrical half sphere</p>	<p>Cylinder diameter</p>
	<p>P600 = 6 Cylindrical flat sloped base</p>	<p>Cylinder diameter and height of bottom</p>
	<p>P600 = 7 Rectangular flat sloped base</p>	<p>Width and breadth of rectangular section and height of bottom</p>

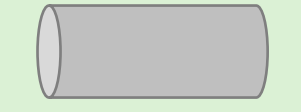

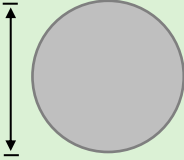
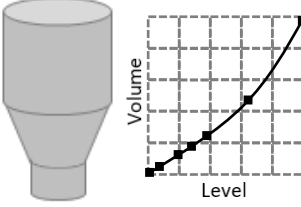
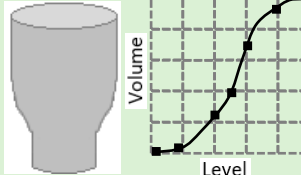
VESSEL SHAPE	P600 VALUE DESCRIPTION	DIMENSIONS
	<p>P600 = 8 Horizontal cylinder with flat ends</p>	<p>Cylinder diameter and tank length</p>
	<p>P600 = 9 Horizontal cylinder with parabolic ends</p>	<p>Cylinder diameter, length of one end and section, and tank length</p>
	<p>P600 = 10 Sphere</p>	<p>Sphere diameter</p>
	<p>P600 = 11 Universal linear</p>	<p>No dimensions required as level, and volume breakpoints are used</p>
	<p>P600 = 12 Universal curved</p>	<p>No dimensions required as level, and volume breakpoints are used</p>

*P601-P603 Vessel Dimensions*

These three parameters are used to enter the dimension required to calculate the volume. The dimensions required are as shown below and are entered **Measurements Units (P104)**.

VESSEL SHAPE	P601	P602	P603
P600 = 0 Cylindrical flat base	Cylinder Diameter	Not required	Not required
P600 = 1 Rectangular flat base	Not required	Width of rectangle	Breadth of rectangle
P600 = 2 Cylindrical cone base	Height of base	Width of rectangle	Not required
P600 = 3 Rectangular pyramid base	Height of base	Width of rectangle	Breadth of rectangle
P600 = 4 Cylindrical parabola base	Height of base	Cylinder diameter	Not required
P600 = 5 Cylindrical half sphere base	Cylinder diameter	Not required	Not required
P600 = 6 Cylindrical flat sloped base	Height of base	Cylinder diameter	Not required
P600 = 7 Rectangular flat sloped base	Height of base	Width of rectangle	Breadth of rectangle
P600 = 8 Horizontal cylinder flat ends	Length of cylinder	Cylinder diameter	Not required
P600 = 9 Horizontal cylinder parabolic ends	Length of cylinder	Cylinder diameter	Length of one end
P600 = 10 Sphere	Sphere diameter	Not required	Not required

*P604 Calculated Volume*

This parameter displays the maximum volume that has been calculated by the dBi and is a Read Only parameter. The volume displayed will be shown in cubic meters and is the total volume available between **empty level (P105)** and 100% of **span (P106)**.

### *P605 Volume Units*

This parameter determines the units that you wish to display, for volume conversion. It is used in conjunction with **P607 (maximum volume)**, and the units are shown on the display (subject to P810). The choices are:

OPTION	DESCRIPTION
0 = No units	Volume will be totalised with <b>no units</b>
1 = Tons	Volume will be totalised in <b>Tons</b>
2 = Tonnes	Volume will be totalised in <b>Tonnes</b>
<b>3 = Cubic metres (Default)</b>	Volume will be totalised in <b>Cubic metres</b>
4 = Litres	Volume will be totalised in <b>Litres</b>
5 = UK Gallons	Volume will be totalised in <b>UK Gallons</b>
6 = US Gallons	Volume will be totalised in <b>US Gallons</b>
7 = Cubic Feet	Volume will be totalised in <b>Cubic Feet</b>
8 = Barrels	Volume will be totalised in <b>Barrels</b>
9 = lbs (pounds)	Volume will be totalised in <b>lbs (pounds)</b>

### *P606 Correction Factor*

This parameter is used to enter a correction factor, when required, such as the specific gravity of the material so that the volume calculated is relative to the actual amount of material that can be contained between **empty level (P105)** and 100% of **span (P106)**. **Default = 1**

### *P607 Max Volume*

This parameter displays the actual maximum volume that has been calculated by the dB<sub>i</sub> 5, i.e., **P604 Calculated Volume x P606 Correction Factor**, and is a Read Only parameter. The volume displayed will be shown in **P605 Volume Units** and is the total volume available between **empty level (P105)** and 100% of **span (P106)**.

## Breakpoints

### *P610-P641 Level/Volume Breakpoints*

These parameters are used to create a profile of the vessel when **P600=11 (universal linear)** or **P600=12 (universal curved)**. You should enter breakpoints in pairs, a reading for level and its corresponding volume. The more pairs you enter, the more accurate the profile will be. In the case of universal linear, then enter the level/volume at each of the points where the vessel changes shape. In the case of the universal curved, enter values around each arc tangent, as well as at the top and bottom.

You must enter at least two pairs, and you can enter up to 32 pairs.

### *Universal Linear (P600=11)*

This volume calculation creates a linear approximation of the level/volume relationship and works best if the vessel has sharp angles between each section.

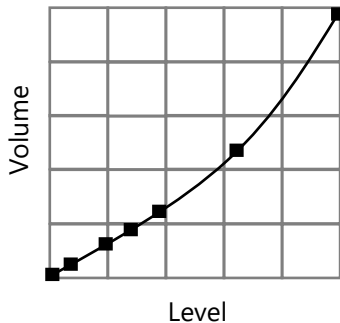

You should enter a level/volume breakpoint for each place where the vessel changes direction, and numerous where the section is slightly curved (mostly linear but has got a small arc). You can enter any number of pairs between 2 and 32.

### *Universal Curved (P600=12)*

This volume calculation creates a curved approximation of the level/volume relationship, and works best if the vessel is non-linear, and there are no sharp angles.

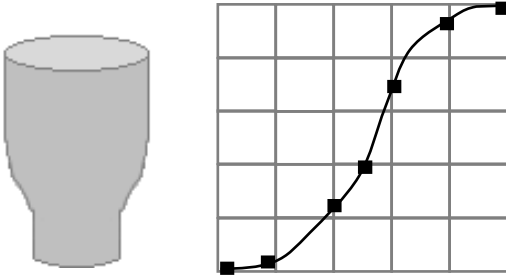

You should enter 2 level/volume breakpoints at the minimum and maximum levels, and several for each place where the vessel has got an arc. You can enter any number of pairs between 2 and 32.

### **Tables**

#### *P696 Reset Breakpoints*

This parameter allows the resetting, to the default value, of all previously set breakpoints (P610-673), without having to access them individually. When it is necessary to reset or amend breakpoints this can be achieved by directly accessing the desired parameter (P610-641) and changing as required.

#### *P697 Number of Breakpoints Set*

This parameter allows you to review the number of breakpoints that have been set, without the need to access each individual one in turn, this is a "Read Only" parameter and no values can be entered.

**mA Output**

*P834 mA Low Level*

This parameter sets, in **Measurement Units (P104)**, the value of 'level', 'distance' or 'space', depending on the selected **Mode of Operation (P100)**, at which 4mA will occur.

*P835 mA High Level*

This parameter sets, in **Measurement Units (P104)**, the value of 'level', 'distance' or 'space', depending on the selected **Mode of Operation (P100)**, at which 20 mA output will occur.

*P838 mA Low Trim*

If the device you are connected to is not calibrated, and not showing the low value, then you can trim it using this parameter. You can either type in the offset directly or use the arrow keys to move the output up and down until you get the expected result on the device that is connected.

*P839 mA High Trim*

If the device you are connected to is not calibrated, and not showing the high value, then you can trim it using this parameter. You can either type in the offset directly or use the arrow keys to move the output up and down until you get the expected result on the device that is connected.

*P808 Fail-safe Mode*

By default, if a fail-safe condition occurs, then the display, relays and the mA output are held at their last **known** values until a valid reading is obtained.

If required, then you can change this so that the unit goes to **high** (100% of span), or **low** (empty) as follows:

OPTION	DESCRIPTION
1 = <b>Known (Default)</b>	Remain at the last <b>known</b> value
2 = High	Will fail to the <b>high</b> value (100% of Span)
3 = Low	Will fail to the <b>low</b> value (0% of Span)
4 = Very High	Will fail to an output value of 22mA
5 = Very Low	Will fail to an output value of 3.75mA

### *P809 Fail-safe Time*

In the event of a fail-safe condition occurring the failsafe timer determines the time before fail-safe mode is activated. **Default = 2.00 mins**

If the timer activates, the unit goes into **fail-safe**, as determined by **P808**, (**Display** and **P840 (mA Output)**). When this happens, you will see the message "**LOE!**" on the display.

When a valid measurement is obtained then the display, relays and mA output will be restored, and the timer is reset.

### *Compensation*

#### *P851 Measurement Offset*

The value of this parameter is added to the measured distance, in **Measurement Units (P104)**.

This Offset will be added to the level, as derived from the transducer, and will affect everything including the reading on the display, the relay setpoints and the mA output.

#### *P852 Temperature Source*

This parameter determines the source of the temperature measurement. By **default**, it is set to internal (transducer) (**P852=1**), which will automatically detect the temperature from the transducer. If for any reason, no temperature input is received, then the **Fixed Temp** value is used, as set by **P854**.

The temperature source can be specifically set as follows:

OPTION	DESCRIPTION
<b>1 = Internal (Default)</b>	Always uses temperature reading from transducer.
3 = Fixed	Always uses fixed temperature (P854)

#### *P854 Fixed Temperature*

This parameter sets the temperature, in degrees centigrade to be used if **P852 (Temperature Source) =3**. **Default = 20°C**

*P860 Sound Velocity*

This option allows for the velocity of sound to be changed according to the atmosphere the transducer is operating in. By **default**, the velocity is set for **342.72m/sec** which is the speed of sound travelling in air at a temperature of **20°C**.

The table below gives details of the velocity of sound in various gaseous atmospheres in all cases the velocity indicated is that in a 100% gaseous atmosphere at 0°C. In atmospheres less than 100% it may be necessary to check the level indicated at near empty and near full and compare with the actual level, several times, then adjust the **Sound Velocity** accordingly to obtain an accurately displayed reading.

OPTION	DESCRIPTION
Chlorine	206 m/sec.
Argon	308 m/sec.
Oxygen	316 m/sec.
Air	331.5 m/sec.
Ammonia	415 m/sec.
Methane	430 m/sec.
Helium	435 m/sec.
Neon	965 m/sec.

*P645 Vapour Temperature Compensation*

The sound velocity in air increases or decreases at a uniform rate of 60cm/sec. per °C, however in atmospheres other than air it will change at a different rate.

This option allows the rate of change in cm/sec. per °C to be set according to the atmosphere and temperature present. The level indicated, should be compared with the actual level, several times, then **Vapour Temperature Compensation** adjusted accordingly, to obtain an accurately displayed reading. **Default = 60 cm/sec. per °C**



## Stability

### Damping

Damping is used to damp the display, to enable it to keep up with the process but ignore minor surface fluctuations.

#### *P870 Fill Damping*

This parameter determines the maximum rate at which the unit will respond to an increase in level. It should be set slightly higher than the maximum vessel fill rate. **Default = 10.000 metres/minute (32.81 feet/minute)**

#### *P871 Empty Damping*

This parameter determines the maximum rate at which the unit will respond to a decrease in level. It should be set slightly higher than the maximum vessel empty rate. **Default = 10.000 metres/minute (32.81 feet/minute)**

### Filters

#### *P881 Fixed Distance*

This parameter determines the width of gate to be used in tracking an echo and under normal circumstances will not require changing, but it can be increased in the cases where the surface is moving extremely fast (in excess of 10m/min) to ensure smooth processing of the changing level.

#### *P884 Peak Percentage*

When P102 = 2 (Solids), this parameter can be used to determine the point at which the measurement is taken, within the established gate of the selected echo, to compensate for any error that maybe caused by "angles of repose" presented by the way the material settles. Please consult Pulsar, for further information and assistance on changing the value of this parameter.

## System

### Important Notice

Parameters 926, 927 and 928 do not affect how the unit performs, but details contained in them may be required, by Pulsar, when making technical enquiries.

### *Password*

#### *P921 Enable Code*

**Enables** the passcode (**P922**), which means the passcode must be entered to go into program mode. If **disabled** (set to **0**), then no passcode is required, and pressing ESC and ENTER button simultaneously will allow entry into the program mode.

#### *P922 Passcode*

This is the passcode that must be used to enter program mode. The **default** is **1997**, but this can be changed to another value.

### *System Information*

#### *P926 Software Revision*

This parameter will display the current software revision.

#### *P927 Hardware Revision*

This parameter will display the current hardware revision. It is read only and cannot be changed.

#### *P928 Serial Number*

This parameter will display the serial number of the unit.

#### *P930 Factory Defaults*

This parameter resets all parameter values to the original Factory Set values that were installed when the unit was tested, before despatch to you.

To **reset** parameters, Set P930 to 1.

### *Date & Time*

The date and time are used, to control specific relay functions and date stamp certain events that are contained in the Data Logs. It is also used in conjunction with the system watchdog that keeps an eye on the times the unit has started.

#### *P931 Date*

This parameter displays the **current date**, in the format as set by **P933 (Date Format)**, and can be reset if required.

#### *P932 Time*

This parameter displays the **current time** and can be reset if required, in the format HH:MM (24-hour format). This is set initially at the factory for UK time.

### *LOE Save Trace*

#### *P950 Save DATEM Trace on LOE*

When enabled this parameter will ensure that in the event of the unit going into a LOE situation a trace at the time of the LOE occurrence is saved for future reference.

OPTION	DESCRIPTION
0 = Off	Feature is disabled and in the event of LOE echo trace will NOT be saved.
1 = Enable (Single Trace)	In the event of a LOE situation an echo trace WILL be saved and stored for future reference. Once a LOE trace has been saved no further traces will be taken
<b>2 = Enable Overwrite (Default)</b>	In the event of an LOE event occurring any previous trace will be overwritten and the last LOE trace saved.

### **DATEM**

#### *P020 Set DATEM*

This parameter allows DATEM to be reset to its default value. To reset DATEM to its default value set parameter value to 1, the trace will then be set to its default value and then update as normal.

#### *P021 Set Dist.*

Allows the user or service personnel to determine which echo is to be displayed. On start-up, if the unit displays an incorrect reading then simply enter the distance from the transducer to the required level and, if an echo is present at this point, the Gate will establish itself around the chosen echo, DATEM will update in front of the Gate and reference out any other unwanted echoes.

It should be noted that DATEM will reset to default values whilst performing this function, and reform itself once it has selected an echo.

Enter distance from **the face of transducer to the target** in units of measurement P104

Values: Min. 0.000, Max. 99.00

*P905 Peak Clearance*

This parameter is used to set the "**height**" above which the DATEM trace will "stand-off" from around unwanted echoes such as obstructions. Please consult Pulsar for further information and assistance on changing the value of this parameter.

*P906 Side Clearance*

This parameter is used to set the "**distance**" by which the DATEM trace will "stand-off" from around unwanted echoes such as obstructions. Please consult Pulsar for further information and assistance on changing the value of this parameter.

## CHAPTER 6 TROUBLESHOOTING

This section describes many common symptoms, with suggestions as to what to do.

POSSIBLE CAUSES	ACTION
Transducer not firing.	Check power supply
Unit indicates a "LOE" situation.	No valid echo being received, and unit has gone into fault condition. Check material level is not out of range, sensor is perpendicular to material surface.
Incorrect reading being obtained for current level.	Measure actual distance from transducer face to surface of material. Access <b>P21</b> , via PC Software type in the <b>measured distance</b> , and <b>Set Parameter</b> .
4-20ma current fixed even though level is changing.	Poll address is above 0 and is in multi drop mode. Change P005 to signal enable
Material level is consistently incorrect by the same amount.	Check empty level (P105) correctly entered.

## CHAPTER 7 DISPOSAL

Incorrect disposal can cause adverse effects to the environment.

Dispose of the device components and packaging material in accordance with regional environmental regulations including regulations for electrical \ electronic products.

### *Transducers*

Remove power, disconnect the Transducer, cut off the electrical cable and dispose of cable and Transducer in accordance with regional environmental regulations for electrical \ electronic products.

### *Controllers*

Remove power, disconnect the Controller, and remove battery (if fitted). Dispose of Controller in accordance with regional environmental regulations for electrical \ electronic products.

Dispose of batteries in accordance with regional environmental regulations for batteries.



 EU WEEE Directive Logo

This symbol indicates the requirements of Directive 2012/19/EU regarding the treatment and disposal of waste from electric and electronic equipment.



**[www.pulsarmeasurement.com](http://www.pulsarmeasurement.com)**

**SUPPORT@PULSARMEASUREMENT.COM**

*Copyright © 2020 Pulsar Measurement Ltd.*

*Registered Address: 1 Chamberlain Square CS, Birmingham B3 3AX*

*Registered No.: 3345604 England & Wales*

*Rev 1.0*